



CorePro LED PLC

CorePro LED PLC 8.5W 840 2P G24d-3

De Philips CorePro LED PL-C integreert LED technologie in een traditionele fluorescentie-lampvorm. Dit product vormt een simpel retrofit-alternatief voor algemene verlichting: het voldoet aan de basiseisen voor verlichting, biedt significante besparingen op energieverbruik en is milieuvriendelijk.

Product gegevens

| Algemene informatie | |
|----------------------------|------------------|
| Lampvoet | G24D-3 [G24d-3] |
| Nominale levensduur (nom.) | 30000 h |
| Schakelcyclus | 50.000X |

| Eisen aan armatuurontwerp | |
|---|---------------------------|
| Kleurcode | 840 [CCT of 4000K (841)] |
| Lichtstroom (nom.) | 1000 lm |
| Gecorreleerde kleurtemperatuur (nom.) | 4000 K |
| Kleurconsistentie | <6 |
| Kleurweergave-index (nom.) | 83 |
| Llmf bij einde nominale levensduur (nom.) | 70 % |

| Bedrijfs- en Elektrische gegevens | |
|--|--------------|
| Ingangsfrequentie | 50 tot 60 Hz |
| Power (Rated) (Nom) | 8.5 W |
| Lampstroom (max.) | 43 mA |
| Lampstroom (min.) | 33 mA |
| Opstarttijd (nom.) | 0,5 s |
| Opwarmtijd tot 60% lichtopbrengst (nom.) | 0,5 s |
| Power Factor (nom.) | 0,9 |
| Spanning (nom.) | 220-240 V |

| Temperatuur | |
|-----------------------------|--------|
| T-omgeving (max.) | 35 °C |
| T-omgeving (min.) | -20 °C |
| T-opslag (max.) | 65 °C |
| T-opslag (min.) | -40 °C |
| T-behuizing maximaal (nom.) | 75 °C |

| Regelsystemen en Dimmers | |
|--------------------------|-----|
| Dimbaar | Nee |

| Mechanische eigenschappen en Behuizing | |
|--|--------|
| Productlengte | 200 mm |

| Goedkeuring en Toepassing | |
|--------------------------------|---|
| Energie-efficiëntielabel (EEL) | A+ |
| Energiebesparend product | Yes |
| Goedkeuringsmerktokens | CE-markering RoHS compliance KEMA Keur-certificaat |
| Energieverbruik kWh/1000 uur | 11 kWh |

| Productgegevens | |
|-----------------------------|------------------------------------|
| Volledige productcode | 871869654125800 |
| Productnaam voor bestelling | CorePro LED PLC 8.5W 840 2P G24d-3 |

CorePro LED PLC

| | |
|----------------------------------|---------------|
| EAN/UPC - Product | 8718696541258 |
| Bestelcode | 54125800 |
| Local Code | CPLC8.5W840D3 |
| Numerator - Aantal per pak | 1 |
| Numerator - Dozen per buitendoos | 10 |

| | |
|--------------------------|--------------|
| Materiaalnr. (12NC) | 929001201302 |
| Netto gewicht (per stuk) | 0,090 kg |

Waarschuwingen en veiligheid

Maatschets

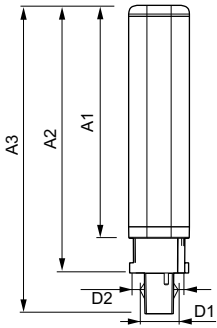

LEDtube PLC 8.5W G24d-3/840 2P

| Product | D1 | D2 | A1 | A2 | A3 |
|------------------------------------|---------|---------|----------|--------|----------|
| CorePro LED PLC 8.5W 840 2P G24d-3 | 24,3 mm | 28,4 mm | 128,8 mm | 148 mm | 170,6 mm |

Fotometrische gegevens

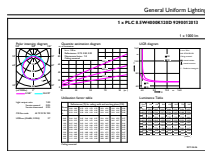

General Information E1 Photo Lighting E1 Page 117

LEDtube PLC 100mm 9W G24D-3 840 1000lm

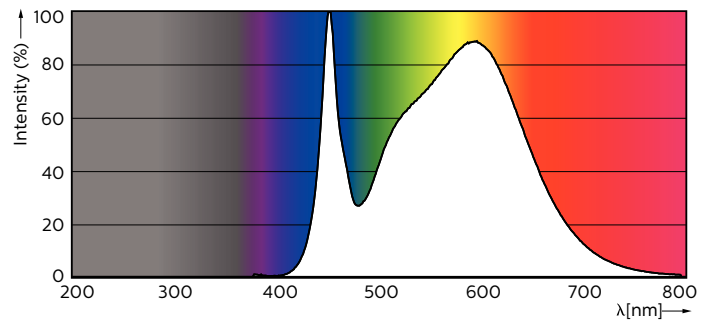

LEDtube PLC 100mm 9W G24Q-3 840 1000lm

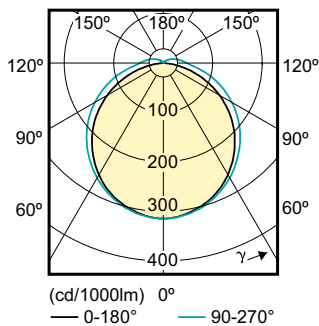

CorePro LED PLC

Levensduur

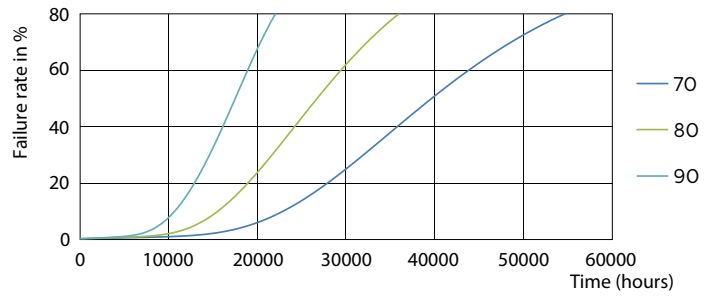

LEDtube PLC 100mm 9W G24D-3 830 950lm

LEDtube PLC 100mm 9W G24D-3 830 950lm

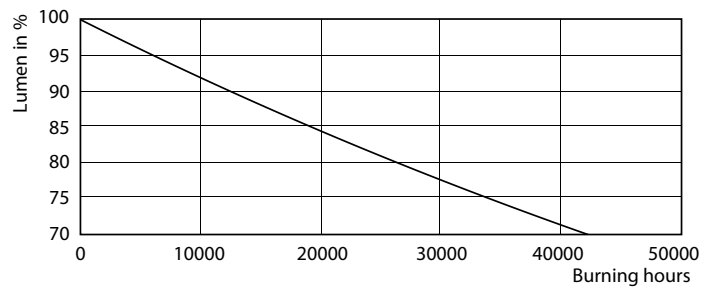
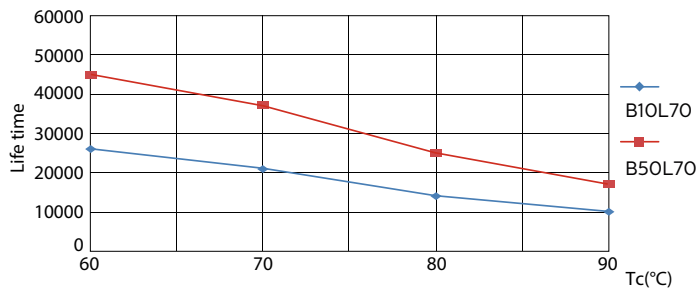

LEDtube PLC 100mm 9W G24D-3 830 950lm

LEDtube PLC 100mm 9W G24D-3 830 950lm

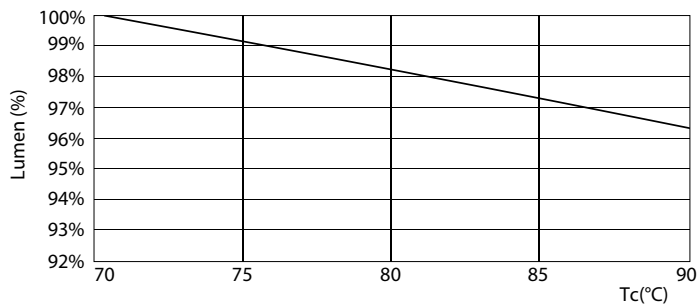

LEDtube PLC 100mm 9W G24D-3 830 950lm

CorePro LED PLC

