



# CorePro LED PLC

## CorePro LED PLC CorePro LED PLC 9W 840 4P G24q-3

De Philips CorePro LED PL-C integreert LED technologie in een traditionele fluorescentie-lampvorm. Dit product vormt een simpel retrofit-alternatief voor algemene verlichting: het voldoet aan de basiseisen voor verlichting, biedt significante besparingen op energieverbruik en is milieuvriendelijk.

### Product gegevens

Algemene informatie	
Lampvoet	G24Q-3 [ G24q-3]
Nominale levensduur (nom.)	30000 h
Schakelcyclus	50.000X
B50L70	30000 h

Eisen aan armatuurontwerp	
Kleurcode	840 [ CCT of 4000K (841)]
Lichtstroom (nom.)	1000 lm
Lichtstroom (opgegeven) (nom.)	1000 lm
Gecorreleerde kleurtemperatuur (nom.)	4000 K
Kleurconsistentie	<6
Kleurweergave-index (nom.)	83
Lmf bij einde nominale levensduur (nom.)	70 %

Bedrijfs- en Elektrische gegevens	
Ingangsfrequentie	30000-80000 Hz
Power (Rated) (Nom)	9 W
Lampstroom (max.)	400 mA
Lampstroom (min.)	250 mA
Opstarttijd (nom.)	0,5 s
Opwarmtijd tot 60% lichtopbrengst (nom.)	0.5 s

Power Factor (nom.)	0.9
Spanning (nom.)	20-50 V

Temperatuur	
T-omgeving (max.)	35 °C
T-omgeving (min.)	-20 °C
T-opslag (max.)	65 °C
T-opslag (min.)	-40 °C
T-behuizing maximaal (nom.)	76 °C

Regelsystemen en Dimmers	
Dimbaar	Nee

Mechanische eigenschappen en Behuizing	
Productlengte	200 mm

Goedkeuring en Toepassing	
Energie-efficiëntielabel (EEL)	A+
Energiebesparend product	Yes
Goedkeuringsmerktokens	CE-markering RoHS compliance KEMA Keur-certificaat

## CorePro LED PLC

Energieverbruik kWh/1000 uur	12 kWh
<b>Productgegevens</b>	
Volledige productcode	871869654117300
Productnaam voor bestelling	CorePro LED PLC CorePro LED PLC 9W 840 4P G24q-3
EAN/UPC - Product	8718696541173
Bestelcode	54117300

Local Code	CPLC9W840Q3
Numerator - Aantal per pak	1
Numerator - Dozen per buitendoos	10
Materiaalnr. (12NC)	929001200902
Netto gewicht (per stuk)	0,088 kg

### Waarschuwingen en veiligheid

- Let op: Het algehele rendement en de lichtdistributie van elke installatie waarbij deze lampen worden toegepast wordt bepaald door het ontwerp van de betreffende installatie.

### Maatschets

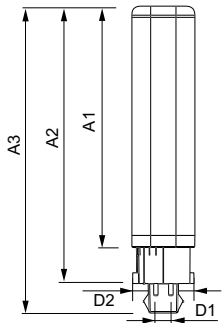

LEDtube PLC 9W G24q-3/840 4P

Product	D1	D2	A1	A2	A3
CorePro LED PLC CorePro LED PLC 9W 840 4P G24q-3	24,3 mm	28,4 mm	128,8 mm	148 mm	163,6 mm

### Fotometrische gegevens

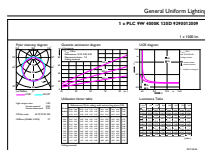

LEDtube PLC 100mm 9W G24Q-3 840 1000lm

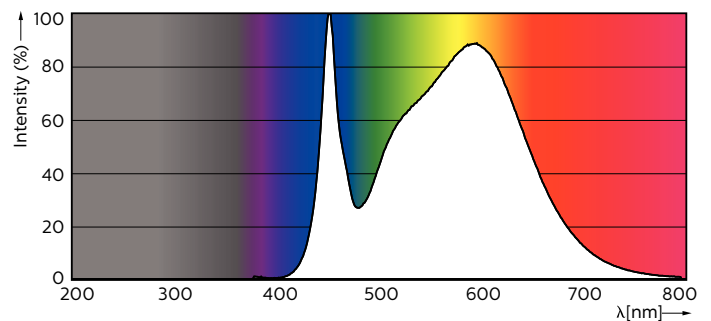

LEDtube PLC 100mm 9W G24Q-3 840 1000lm

# CorePro LED PLC

## Fotometrische gegevens

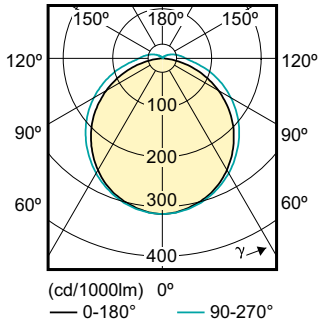

## Levensduur

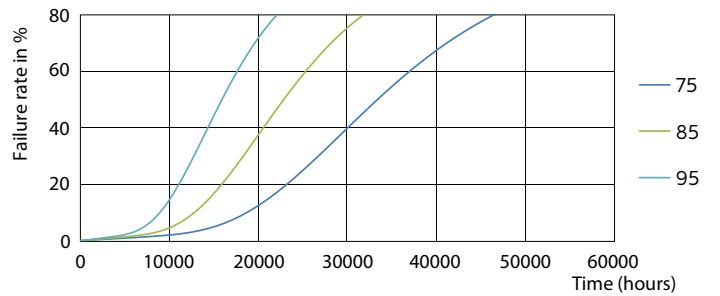
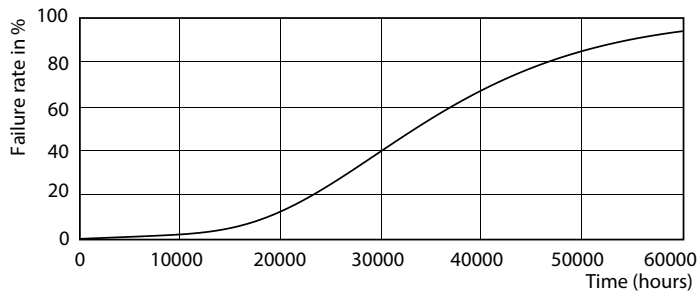

LEDtube PLC 100mm 9W G24Q-3 830 950lm

LEDtube PLC 100mm 9W G24Q-3 830 950lm

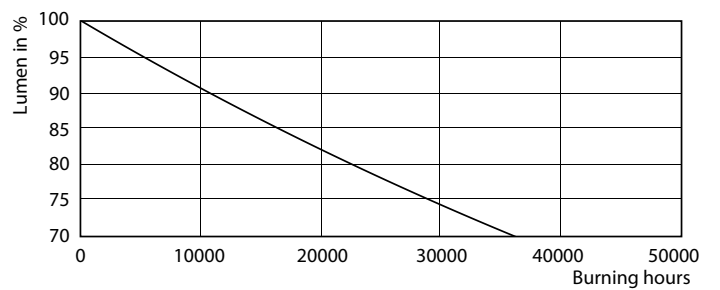
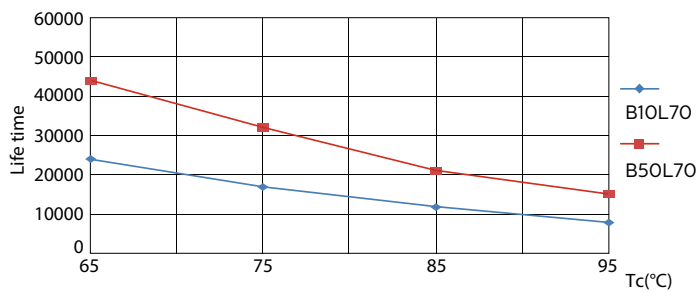

LEDtube PLC 100mm 9W G24Q-3 830 950lm

LEDtube PLC 100mm 9W G24Q-3 830 950lm

## CorePro LED PLC

### Levensduur

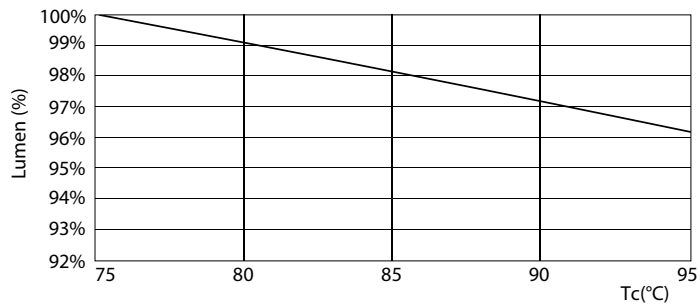

LEDtube PLC 100mm 9W G24Q-3 830 950lm

