

# General Purpose Fuses



## NH Fuse System

DIN 57 636/VDE 0636 Parts 1, 10, 21, 22, 201  
IEC 60269-2  
DIN 43 620 Parts 1 to 4 (Standard dimensions)

The utilization category is identified by two letters, the first indicating the **operational class** and the second the **object to be protected**. The Lindner range includes fuse-links to DIN VDE 0636 standard for the following utilization categories:

- gG: general purpose cable and line protection
- aM: backup switchgear and controlgear protection
- gTr: general purpose transformer protection
- gR: general purpose, fast acting
- aR: partial purpose, fast acting

### Classification

The NH system is classed among plug-in fuse systems and is comprised of:

- fuse-base, (possibly including terminal covers and phase barriers)
- fuse-link with blade contact
- fuse-link replacement device (LV HRC fuse puller)

Since the design of this system cannot guarantee non-interchangeability of rated current, it must be handled by a qualified professional.

### Approval symbols



Beige melted



Red non melted

- ~ 0% lead
- ~ 0% cadmium
- ~ it costs you not a eanny more !
- ~ it corresponds with the 2nd design of European electronical scraps guideline
- ~ 100% for a sure future

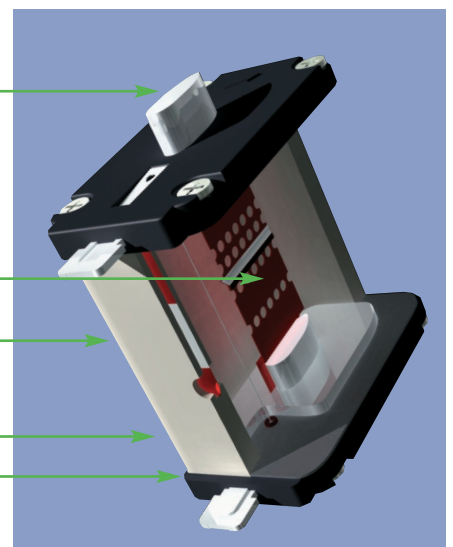

# General Purpose Fuses



NH Fuses

## 500V-gG



NH-Fuse-links  
**~500 V-gG**  
 Breaking capacity : 120 KA  
 with voltage-conducting grip  
 lug, combination recognition  
 signal, contact blades,  
 complying with DIN VDE 0636 part  
 201

**Cd/Pb-free**



Beige melted



Red non melted

SIZE	RATED In CURRENT (A)	POWER LOSSES In (W)	CATALOG NUMBER	REFERENCE NUMBER	PACK.
000/C00	2	3,3	1B613.000000	B211946	3
	4	1,4	1B619.000000	M212462	3
	6	1,7	1B623.000000	D213995	3
	10	1,0	1B631.000000	B219651	3
	16	1,8	1B635.000000	K222097	9
	20	2,4	1B637.000000	A222847	9
	25	3,9	1B639.000000	E201185	9
	32	2,7	1B643.000000	Z211438	9
	35	2,9	1B645.000000	C211947	9
	40	3,4	1B647.000000	N212463	9
	50	3,9	1B651.000000	T212974	9
	63	4,7	1B655.000000	E213996	9
	80	5,9	1B659.000000	Y216543	9
100	6,8	1B663.000000	B219122	9	
00	125	8,4	1B765.000000	R201863	3
	160	10,5	1B769.000000	P211084	3
0	6	1,8	1B023.000000	H213148	3
	10	1,5	1B031.000000	G214159	3
	16	2,4	1B035.000000	Q215179	3
	20	3,5	1B037.000000	R215686	3
	25	3,2	1B039.000000	Y216198	3
	32	3,2	1B043.000000	W216702	3
	35	3,5	1B045.000000	J217220	3
	40	4,1	1B047.000000	P217731	3
	50	5,1	1B051.000000	Z218246	3
	63	6,2	1B055.000000	N218765	3
	80	7,1	1B059.000000	C219284	3
	100	8,7	1B063.000000	D219814	3
	125	11,0	1B065.000000	P222492	3
	160	11,7	1B069.000000	F223013	3
	200		1B071.000000	C229611	3
	224		1B073.000000	D229612	3
	250		1B075.000000	E229613	3
1	16	2,4	1B135.000000	M200801	3
	20	3,5	1B137.000000	C201344	3
	25	3,2	1B139.000000	N201860	3
	32	3,2	1B143.000000	L211081	3
	35	3,7	1B145.000000	A211600	3
	40	4,2	1B147.000000	Y212633	3
	50	5,1	1B151.000000	B213648	3
	63	5,8	1B155.000000	L214669	3
	80	7,2	1B159.000000	S215687	3
	100	8,5	1B163.000000	X216703	3
	125	11,0	1B165.000000	Q217732	3
	160	13,0	1B169.000000	A218247	3
	200	14,5	1B171.000000	P218766	3
	224	15,9	1B173.000000	D219285	3
	250	20,0	1B175.000000	E219815	3
2	35	3,6	1B245.000000	P201861	3
	50	5,1	1B251.000000	B211601	3
	63	5,8	1B255.000000	Z212634	3
	80	7,0	1B259.000000	C213649	3
	100	8,6	1B263.000000	M214670	3
	125	10,6	1B265.000000	T215688	3
	160	13,0	1B269.000000	Y216704	3
	200	14,0	1B271.000000	R217733	3
	224	15,4	1B273.000000	Q218767	3
	250	20,0	1B275.000000	R222494	3
	300	22,5	1B277.000000	P200803	3
	315	24,0	1B279.000000	E201346	3
	350	26,2	1B281.000000	Q201862	3
	400	29,0	1B283.000000	N211083	3

\* Previous design with frontal indicator  
 Characteristic curves, see page 97  
 Dimensions, see page 101

# General Purpose Fuses



## 500V-gG



NH-Fuse-links  
~500 V-gG  
with voltage-conducting grip  
lug, combination recognition  
signal, contact blades,  
complying with DIN VDE 0636  
part 201

**Cd/Pb-free**

With screw contact

Contact blades for  
NH-bottom SIZE 4A  
with transient device

SIZE	RATED In CURRENT (A)	POWER LOSSES In (W)	CATALOG NUMBER	REFERENCE NUMBER	PACK.
3	250	18,0	1B375.000000	C211602	1
	300	20,0	1B377.000000	A212635	1
	315	22,4	1B379.000000	L213151	1
	355	23,5	1B381.000000	K214162	1
	400	31,0	1B383.000000	T215182	1
	425	33,0	1B385.000000	B216201	1
	450	37,0	1B386.000000	Z216705	1
	500	44,0	1B387.000000	M217223	1
	630	47,0	1B389.000000	S217734	1
4*	400	31,0	08004.400700	A216039	1
	500	35,0	08004.500700	X216542	1
	630	44,0	08004.630700	W217576	1
	800	70,0	08004.800700	E218090	1
	1000	85,0	08004.100700	H201694	1
	1250	93,0	08004.125700	C213994	1
4a*	500	35,0	08014.500700	D201184	1
	630	44,0	08014.630700	T205752	1
	800	70,0	08014.800700	Y211437	1
	1000	85,0	08014.100700	A219650	1
	1250	93,0	08014.125700	J200637	1

\* With frontal indicator  
Corrosion-resistant design with V2A-screws: on request  
Characteristic curves, see page 97  
Dimensions, see page 101

Additional Microswitch

### Accessories



#### Microswitch – Sizes 000 to 3

MS4L2-5B6+PRES	F210156	3
MS4L2-5B2+PRES	G210157	3



Beige melted



Red non melted

#### Microswitch Mounted



BEFORE

AFTER

# General Purpose Fuses



NH Fuses

## 500V-gG Isolated grip lugs



NH-Fuse links  
 ~500 V-gG  
 with voltage-free  
 metal grip lugs (SGL version),  
 combination recognition signal,  
 contact blades,  
 complying with DIN VDE 0636 part 201

**Cd/Pb-free**



Beige melted



Red non melted

Corrosion-resistant design with V2A screws: on request

Characteristic curves page 97  
 Dimensions page 101

No additional microswitch

SIZE	RATED In CURRENT (A)	POWER LOSSES In (W)	CATALOG NUMBER	REFERENCE NUMBER	PACK.	
000/C00	2	3,3	1F613.000000	C219652	9	
	4	1,4	1F619.000000	N205770	9	
	6	1,7	1F623.000000	P212464	9	
	10	1,0	1F631.000000	V215528	9	
	16	1,8	1F635.000000	F213997	9	
	20	2,4	1F637.000000	F218091	9	
	25	2,3	1F639.000000	K200638	9	
	32	2,7	1F643.000000	D213489	9	
	35	2,9	1F645.000000	G201187	9	
	40	3,4	1F647.000000	D219653	9	
	50	3,9	1F651.000000	C222849	9	
	63	4,7	1F655.000000	R212466	9	
	80	5,9	1F659.000000	N215016	9	
100	6,8	1F663.000000	J201189	9		
00	125	8,4	1F765.000000	V200808	3	
	160	10,5	1F769.000000	W201867	3	
0	6	1,8	1F023.000000	B212636	3	
	10	1,5	1F031.000000	M213152	3	
	16	2,4	1F035.000000	E213651	3	
	20	3,5	1F037.000000	L214163	3	
	25	3,2	1F039.000000	P214672	3	
	32	3,2	1F043.000000	V215183	3	
	35	3,5	1F045.000000	W215690	3	
	40	4,1	1F047.000000	C216202	3	
	50	5,1	1F051.000000	A216706	3	
	63	6,2	1F055.000000	N217224	3	
	80	7,1	1F059.000000	T217735	3	
	100	8,7	1F063.000000	D218250	3	
	125	11,0	1F065.000000	S218769	3	
	160	11,7	1F069.000000	F219287	3	
	1	16	2,4	1F135.000000	H219818	3
		20	3,5	1F137.000000	T222496	3
25		3,2	1F139.000000	K223017	3	
32		3,2	1F143.000000	R200805	3	
35		3,7	1F145.000000	G201348	3	
40		4,2	1F147.000000	Q211085	3	
50		5,1	1F151.000000	L212116	3	
63		5,8	1F155.000000	N213153	3	
80		7,2	1F159.000000	M214164	3	
100		8,3	1F163.000000	W215184	3	
125		11,0	1F165.000000	D216203	3	
160		13,0	1F169.000000	B216707	3	
200		14,5	1F171.000000	P217225	3	
224		15,9	1F173.000000	V217736	3	
250		20,0	1F175.000000	E218251	3	
2		35	3,6	1F245.000000	L223018	3
	50	5,1	1F251.000000	H201349	3	
	63	5,8	1F255.000000	T201865	3	
	80	7,0	1F259.000000	F211605	3	
	100	8,6	1F263.000000	P213154	3	
	125	10,6	1F265.000000	N214165	3	
	160	13,0	1F269.000000	X215185	3	
	200	14,0	1F271.000000	E216204	3	
	224	15,4	1F273.000000	Q217226	3	
	250	20,0	1F275.000000	F218252	3	
	300	22,5	1F277.000000	H219289	3	
	315	24,0	1F279.000000	K219820	3	
	355	26,2	1F281.000000	M223019	3	
	400	29,0	1F283.000000	T200807	3	
3	250	18,0	1F375.000000	J201350	1	
	300	20,0	1F377.000000	S211087	1	
	315	22,4	1F379.000000	G211606	1	
	355	23,5	1F381.000000	E212639	1	
	400	32,0	1F383.000000	H213654	1	
	425	33,0	1F385.000000	S214675	1	
	450	37,0	1F386.000000	Z215693	1	
	500	44,0	1F387.000000	F216205	1	
	630	46,0	1F389.000000	D216709	1	

# General Purpose Fuses



## 400V-gG



NH-Fuse links  
~400 V-gG  
with voltage-conducting grip  
lug, combination recognition  
signal, contact blades,  
complying with DIN VDE 0636  
part 201  
Available from mid-2000

**Cd/Pb-free**



Beige melted



Red non melted

SIZE	RATED In CURRENT (A)	POWER LOSSES In (W)	CATALOG NUMBER	REFERENCE NUMBER	PACK.	
000/00C	2	3,3	1A613.000000	Z223674	9	
	4	1,35	1A619.000000	A223675	9	
	6	1,7	1A623.000000	B223676	9	
	10	1,0	1A631.000000	C223677	9	
	16	1,8	1A635.000000	D223678	9	
	20	2,0	1A637.000000	E223679	9	
	25	2,4	1A639.000000	F223680	9	
	32	2,6	1A643.000000	G223681	9	
	35	3,2	1A645.000000	H223682	9	
	40	3,1	1A647.000000	J223683	9	
	50	3,5	1A651.000000	K223684	9	
	63	4,6	1A655.000000	L223685	9	
	80	5,0	1A659.000000	M223686	9	
100	5,5	1A663.000000	N223687	9		
00	125	8,6	1A765.000000	E223702	3	
	160	9,6	1A769.000000	F223703	3	
1	35	3,9	1A145.000000	J223706	3	
	50	4,5	1A151.000000	K223707	3	
	63	5,7	1A155.000000	L223708	3	
	80	5,5	1A159.000000	M223709	3	
	100	7,0	1A163.000000	N223710	3	
	125	9,1	1A165.000000	P223711	3	
	160	13,0	A169.000000	Q223712	3	
	200	13,1	1A171.000000	R223713	3	
	224	15,1	1A173.000000	S223714	3	
	250	16,9	1A175.000000	T223715	3	
	2	80	6,1	1A259.000000	F223726	3
		35	7,3	1A245.000000	T227257	3
		50	9,1	1A251.000000	V227258	3
63		13,0	1A255.000000	W227259	3	
200		13,5	1A271.000000	K223730	3	
224		15,1	1A273.000000	L223731	3	
250		18,0	1A275.000000	M223732	3	
315		19,9	1A279.000000	N223733	3	
355		22,7	1A281.000000	P223734	3	
400		28,0	1A283.000000	Q223735	3	
3		250	19,9	1A375.000000	R223736	1
	315	22,7	1A379.000000	S223737	1	
	400	28,0	1A383.000000	T223738	1	
	500	30,8	1A387.000000	V223739	1	
	630	43,0	1A389.000000	W223740	1	

Corrosion-resistant design with V2A screws : on request

Characteristic curves see page 97

Dimensions see page 101

Additional Microswitch

### Accessories



#### Microswitch – Sizes 000 to 3

MS4L2-5B6+PRES	F210156	3
MS4L2-5B2+PRES	G210157	3

#### Microswitch Mounted

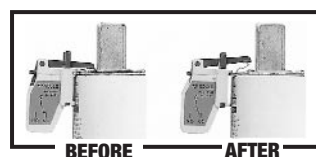

# General Purpose Fuses



NH Fuses

## 400V gL-gG Isolated grip lugs



NH-Fuse-links  
~400 V-gG  
with voltage-free metal grip  
lugs (SGL version),  
combination recognition signal,  
contact blades, complying with  
DIN VDE 0636 part 201  
Available from mid-2000

**Cd/Pb-free**



Beige melted



Red non melted

SIZE	RATED In CURRENT (A)	POWER LOSSES In (W)	CATALOG NUMBER	REFERENCE NUMBER	PACK.
000	2	3,3	1E613.000000	P223688	9
	4	1,35	1E619.000000	Q223689	9
	6	1,7	1E623.000000	R223690	9
	10	1,0	1E631.000000	S223691	9
	16	1,8	1E635.000000	T223692	9
	20	2,0	1E637.000000	V223693	9
	25	2,4	1E639.000000	W223694	9
	32	2,6	1E643.000000	X223695	9
	35	3,2	1E645.000000	Y223696	9
	40	3,1	1E647.000000	Z223697	9
	50	3,5	1E651.000000	A223698	9
	63	4,6	1E655.000000	B223699	9
	80	5,0	1E659.000000	C223700	9
	100	5,5	1E663.000000	D223701	9
00	125	8,6	1E765.000000	G223704	3
	160	9,6	1E769.000000	H223705	3
1	35	3,9	1E145.000000	V223716	3
	50	4,5	1E151.000000	W223717	3
	63	5,7	1E155.000000	X223718	3
	80	5,5	1E159.000000	Y223719	3
	100	7,0	1E163.000000	Z223720	3
	125	9,1	1E165.000000	A223721	3
	160	13,0	1E169.000000	B223722	3
	200	13,1	1E171.000000	C223723	3
	224	15,1	1E173.000000	D223724	3
	250	16,9	1E175.000000	E223725	3
2	35	6,1	1E245.000000	L227250	3
	50	7,3	1E251.000000	M227251	3
	63	9,1	1E255.000000	N227251	3
	160	13,0	1E269.000000	A223744	3
	200	13,5	1E271.000000	B223745	3
	224	15,1	1E273.000000	C223746	3
	250	18,0	1E275.000000	D223747	3
	315	19,9	1E279.000000	E223748	3
	355	22,7	1E281.000000	F223749	3
	400	28,0	1E283.000000	G223750	3
3	250	19,9	1E375.000000	H223751	1
	315	22,7	1E379.000000	J223752	1
	400	28,0	1E383.000000	K223753	1
	500	30,8	1E387.000000	L223754	1
	630	43,0	1E389.000000	M223755	1

Corrosion-resistant design with V2A screws: on request

Characteristic curves page 97  
Dimensions see 102

No Additional Microswitch



# General Purpose Fuses



NH Fuses

## 690V gL-gG



NH Fuse-links  
~690 V gL-gG  
with voltage-conducting grip lug,  
contact blades,  
complying with DIN VDE 0636  
part 21,  
DIN 43620 part 1

SIZE	RATED In CURRENT (A)	POWER LOSSES In (W)	CATALOG NUMBER	REFERENCE NUMBER	PACK.	
000/00C	2	1,4	1C613.000000	E228440	3	
	4	1,1	1C619.000000	F228441	3	
	6	1,3	1C623.000000	G228442	3	
	8		1C627.000000	H228448	3	
	10	1,6	1C631.000000	J228444	3	
	16	1,8	1C635.000000	K228445	3	
	20	2,3	1C637.000000	L228446	3	
	25	2,6	1C639.000000	M228447	3	
	32	3,2	1C643.000000	N228448	3	
	35	3,6	1C645.000000	P228449	3	
	40	4,0	1C647.000000	Q228450	3	
	50	4,9	1C651.000000	R228451	3	
	63	5,6	1C655.000000	S228452	3	
	80	6,2	1C659.000000	T228453	3	
	00	30	7,0	1C743.000000	V228454	3
		35	1,1	1C745.000000	W228455	3
40		1,3	1C747.000000	X228456	3	
50		1,9	1C751.000000	Y228457	3	
63		2,4	1C755.000000	Z228458	3	
80		2,7	1C759.000000	A228459	3	
100		4,0	1C763.000000	B228460	3	
125		4,3	1C765.000000	C228461	3	
0	6	4,9	1C023.000000	D228462	3	
	10	5,6	1C031.000000	E228463	3	
	16	6,3	1C035.000000	F228464	3	
	20	7,2	1C037.000000	G228465	3	
	25	8,5	1C039.000000	H228466	3	
	32	10,8	1C043.000000	J228467	3	
	35	14,0	1C045.000000	K228468	3	
	40	1,9	1C047.000000	L228469	3	
	50	2,4	1C051.000000	M228470	3	
	63	2,7	1C055.000000	N228471	3	
	80	4,0	1C059.000000	P228472	3	
	100	4,3	1C063.000000	Q228473	3	
	125	4,9	1C065.000000	R228474	3	
	160	5,6	1C069.000000	S228475	3	
1	16	6,3	1C135.000000	T228476	3	
	20	7,2	1C137.000000	V228477	3	
	25	8,5	1C139.000000	W228478	3	
	32	10,8	1C143.000000	X228479	3	
	35	14,0	1C145.000000	Y228480	3	
	40	16,0	1C147.000000	Z228481	3	
	50	4,0	1C151.000000	A228482	3	
	63	4,3	1C155.000000	B228483	3	
	80	4,9	1C159.000000	C228484	3	
	100	5,6	1C163.000000	D228485	3	
	125	6,3	1C165.000000	E228486	3	
	160	7,5	1C169.000000	F228487	3	
	200	8,8	1C171.000000	G228488	3	

### Microswitch – Sizes 000 to 3

MS4L2-5B6+PRES	F210156	3
MS4L2-5B2+PRES	G210157	3

SIZE	RATED In CURRENT (A)	POWER LOSSES In (W)	CATALOG NUMBER	REFERENCE NUMBER	PACK.
2	32	11,5	1C243.000000	H228489	3
	35	14,0	1C245.000000	J228490	3
	40	17,0	1C247.000000	K228491	3
	50	19,0	1C251.000000	L228492	3
	63	21,0	1C255.000000	M228493	3
	80	23,0	1C259.000000	N228494	3
	100	25,2	1C263.000000	P228495	3
	125	17,0	1C265.000000	Q228496	3
	160	21,0	1C269.000000	R228497	3
	200	23,0	1C271.000000	S228498	3
	224	25,2	1C273.000000	T228499	3
	250	32,6	1C275.000000	V228500	3
	300	36,0	1C277.000000	W228501	3
	315	43,0	1C279.000000	X228502	3
	355	33,0	1C281.000000	Y228503	3
	3	250	33,0	1C375.000000	Z228504
300		58,0	1C377.000000	A228505	1
315		71,0	1C379.000000	B228506	1
355		33,0	1C381.000000	C228507	1
400		43,0	1C383.000000	D228508	1
425		58,0	1C385.000000	E228509	1
500		71,0	1C387.000000	F228510	1

With screw contact

Contact blade  
for NH-bottom SIZE 4a  
with transient device

Characteristic curves page 97  
Dimensions page 102

Additional Microswitch



Beige melted



Red non melted

### Accessories



### Microswitch Mounted

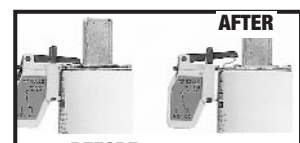

BEFORE

# General Purpose Fuses



NH Fuses

## 690V-gG Isolated grip lugs



NH Fuse-links  
~690 V-gG  
with voltage-free metal grip  
lugs, frontal combination  
recognition signal,  
contact blades,  
complying with DIN VDE 0636 part 21,  
DIN 43620 part 1



Beige melted



Red non melted

Characteristic curves page 97  
Dimensions page 102

No Additional Microswitch

SIZE	RATED In CURRENT (A)	POWER LOSSES In (W)	CATALOG NUMBER	REFERENCE NUMBER	PACK.
000/00C	2	1,4	1G613.000000	D229704	3
	4	1,1	1G619.000000	E229705	3
	6	1,3	1G623.000000	F229706	3
	8	1,6	1G627.000000	G229707	3
	10	1,8	1G631.000000	H229708	3
	16	2,3	1G635.000000	J229709	3
	20	2,6	1G637.000000	K229710	3
	25	3,2	1G639.000000	L229711	3
	32	3,6	1G643.000000	M229712	3
	35	4,0	1G645.000000	N229713	3
	40	4,9	1G647.000000	P229714	3
	50	5,6	1G651.000000	Q229715	3
	63	6,2	1G655.000000	R229716	3
	80	7,0	1G659.000000	S229717	3
00	32	3,1	1G743.000000	T229718	3
	35	3	1G745.000000	V229719	3
	40	3,7	1G747.000000	W229720	3
	50	4,1	1G751.000000	X229721	3
	63	5,6	1G755.000000	Y229722	3
	80	6,8	1G759.000000	Z229723	3
	100	7,5	1G763.000000	A229724	3
	125	10	1G765.000000	B229725	3
0	6	1,6	1G023.000000	C229726	3
	10	1,1	1G031.000000	D229727	3
	16	1,8	1G035.000000	E229728	3
	20	2,3	1G037.000000	F229729	3
	25	2,4	1G039.000000	G229730	3
	32	3,1	1G043.000000	H229731	3
	35	3	1G045.000000	J229732	3
	40	3,7	1G047.000000	K229733	3
	50	4,1	1G051.000000	L229734	3
	63	6,6	1G055.000000	M229735	3
	80	8	1G059.000000	N229736	3
	100	9,4	1G063.000000	P229737	3
	125	11,8	1G065.000000	Q229738	3
	160	14,6	1G069.000000	R229739	3
1	16	4,3	1G135.000000	S229740	1
	20	4,9	1G137.000000	T229741	1
	25	5,6	1G139.000000	V229742	1
	32	6,3	1G143.000000	W229743	1
	35	7,2	1G145.000000	X229744	1
	40	8,5	1G147.000000	Y229745	1
	50	10,8	1G151.000000	Z229746	1
	63	14,0	1G155.000000	A229747	1
	80	16,0	1G159.000000	B229748	1
	100	4,0	1G163.000000	C229749	1
	125	4,3	1G165.000000	D229750	1
	160	4,9	1G169.000000	E229751	1
	200	5,6	1G171.000000	F229752	1
	224	6,3	1G173.000000	G229753	1
250	7,5	1G175.000000	H229754	1	
2	32	8,8	1G243.000000	J229755	1
	35	11,5	1G245.000000	K229756	1
	40	14,0	1G247.000000	L229757	1
	50	17,0	1G251.000000	M229758	1
	63	19,0	1G255.000000	N229759	1
	80	21,0	1G259.000000	P229760	1
	100	23,0	1G263.000000	Q229761	1
	125	25,2	1G265.000000	R229762	1
	160	15	1G269.000000	S229763	1
	200	18,5	1G271.000000	T229764	1
	224	19,2	1G273.000000	V229765	1
	250	20,6	1G275.000000	W229766	1
	300	21	1G277.000000	X229767	1
	315	25	1G279.000000	Y229768	1
355	31,5	1G281.000000	Z229769	1	
3	250	21,1	1G375.000000	A229770	1
	300	23,8	1G377.000000	B229771	1
	315	25	1G379.000000	C229772	1
	355	32	1G381.000000	D229773	1
	400	34	1G383.000000	E229774	1
	425	34	1G385.000000	F229775	1
	500	43	1G387.000000	G229776	1



# General Purpose Fuses



NH Fuses

## 400V gTr

NH fuse-links for transformers



NH Fuse-links

**~400 V**

with voltage-conducting grip lug,  
combination recognition signal,  
contact blades, complying with  
DIN VDE 0636 part 22,  
DIN 43620 part 1

SIZE	Trans. Power in KVA (400V~)	RATED In CURRENT (A)	POWER LOSSES In (W)	CATALOG NUMBER	REFERENCE NUMBER	PACK.
2	50	145	12	5A251.000000	H232813	1
	75	181	15	5A257.000000	G232812	1
	100	231	18,4	5A263.000000	B232807	1
	125	289	22	5A265.000000	C232808	1
	160	361	27	5A269.000000	D232809	1
	200			5A271.000000	E232810	1
	250			5A275.000000	F232811	1
	3	250	361	26	5A375.000000	J232814
315		455	34	5A379.000000	K232815	1
400		578	39	5A383.000000	L232816	1
500		723	49	5A387.000000	M232817	1
630		910	69	5A389.000000	N232818	1

Characteristic curves page 100  
Dimensions page 102

Contact blade  
for NH-bottom SIZE 4a  
with transient device

# General Purpose Fuses



500V

Class gI-gG -500 V

## TOTAL CLEARING I<sup>2</sup>t

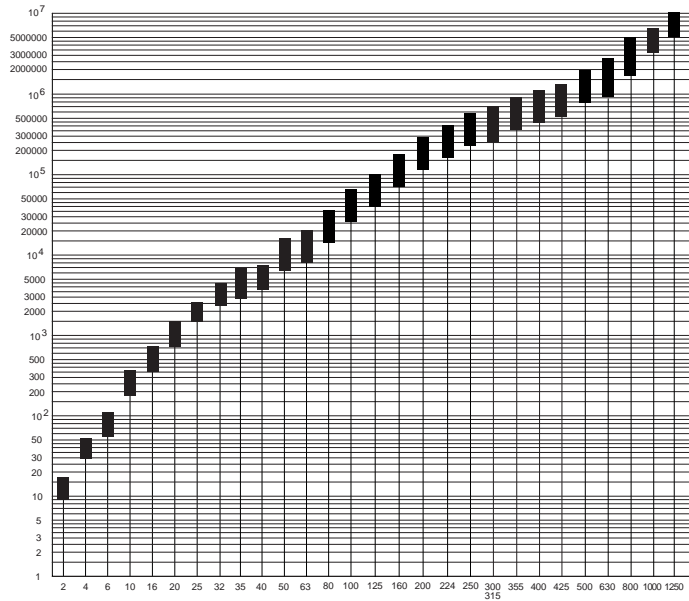

## CURRENT LIMITATION CURVES

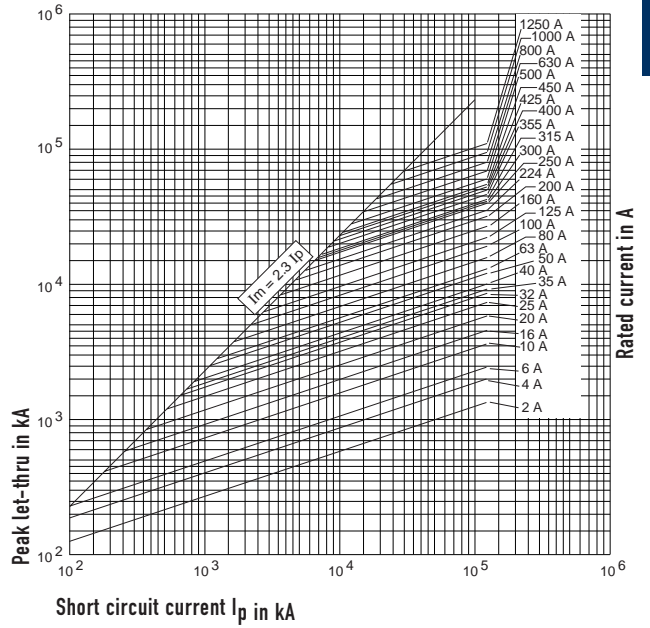

## TIME VS. CURRENT CHARACTERISTICS

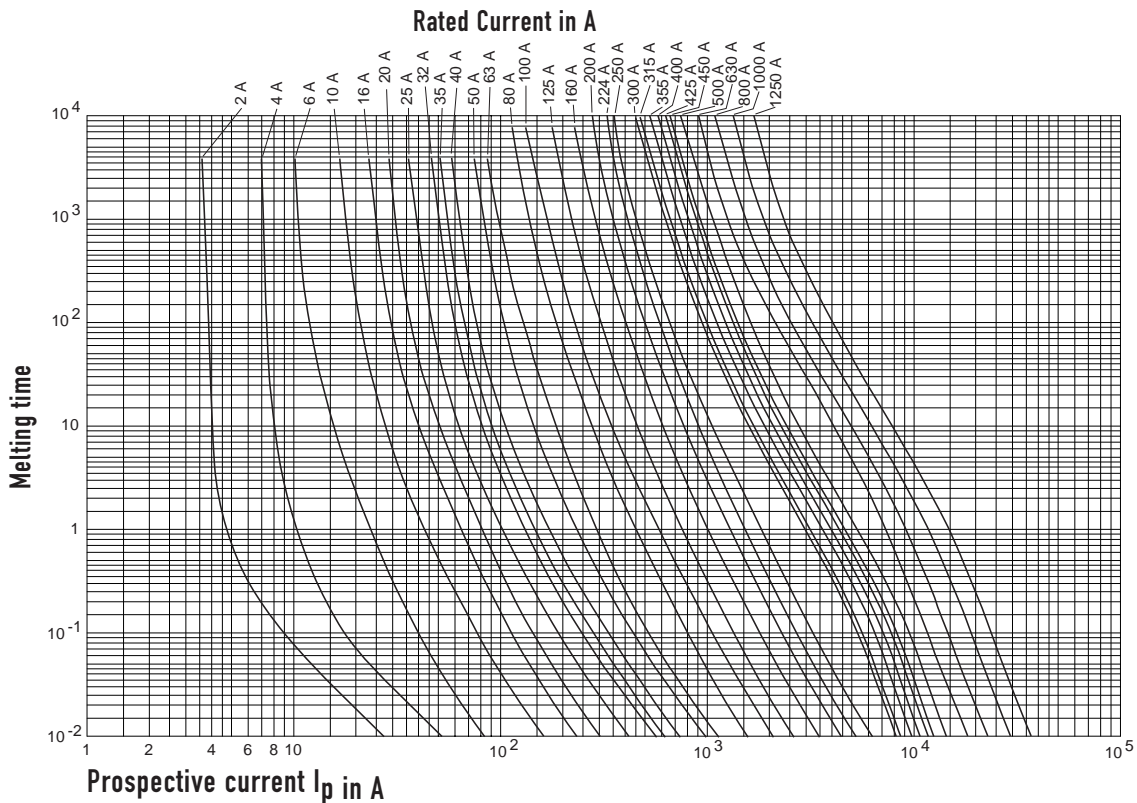

# General Purpose Fuses



**500V**

**Class gLgG - 690 V**

## TOTAL CLEARING I<sup>2</sup>t

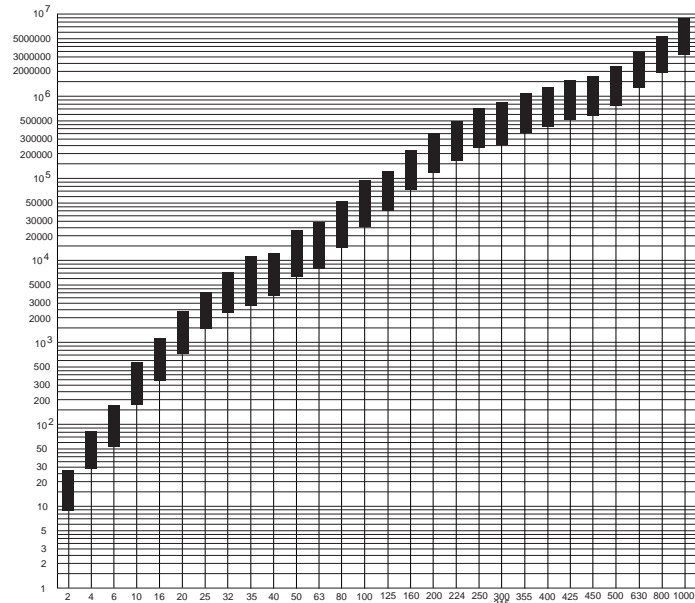

## CURRENT LIMITATION CURVES

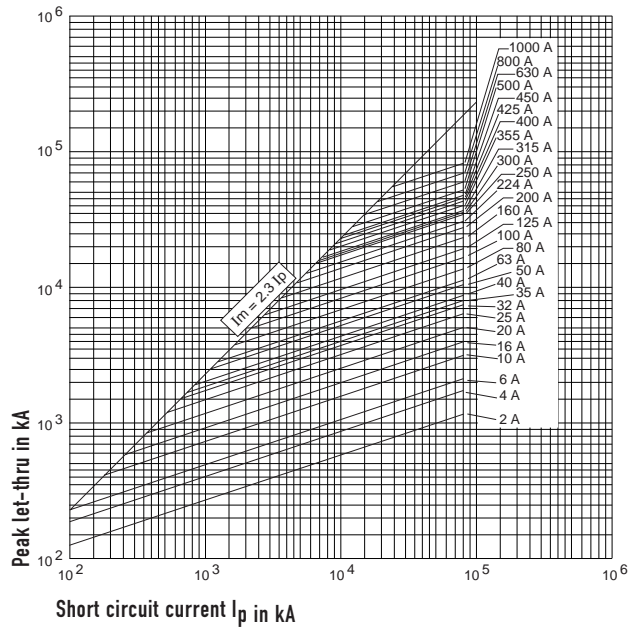

## TIME VS. CURRENT CHARACTERISTICS

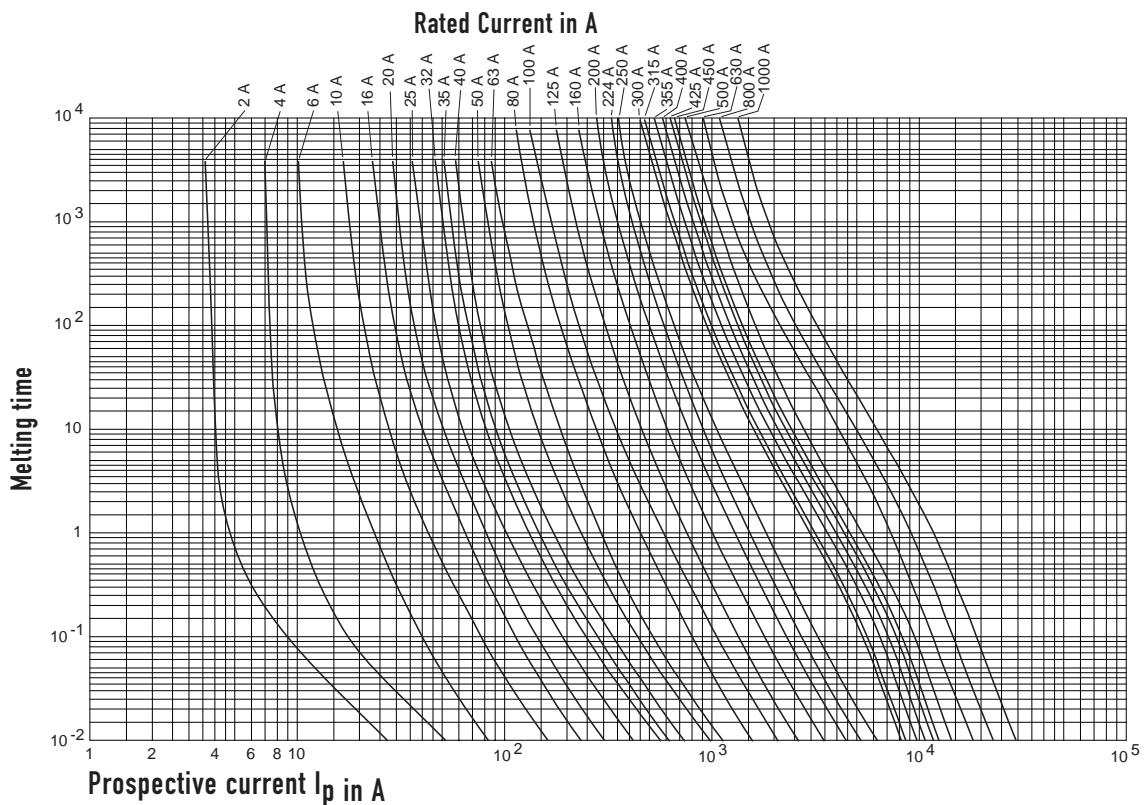

# General Purpose Fuses



NH Fuses

## Melting - time current data

Class gTr, ~ 400 V

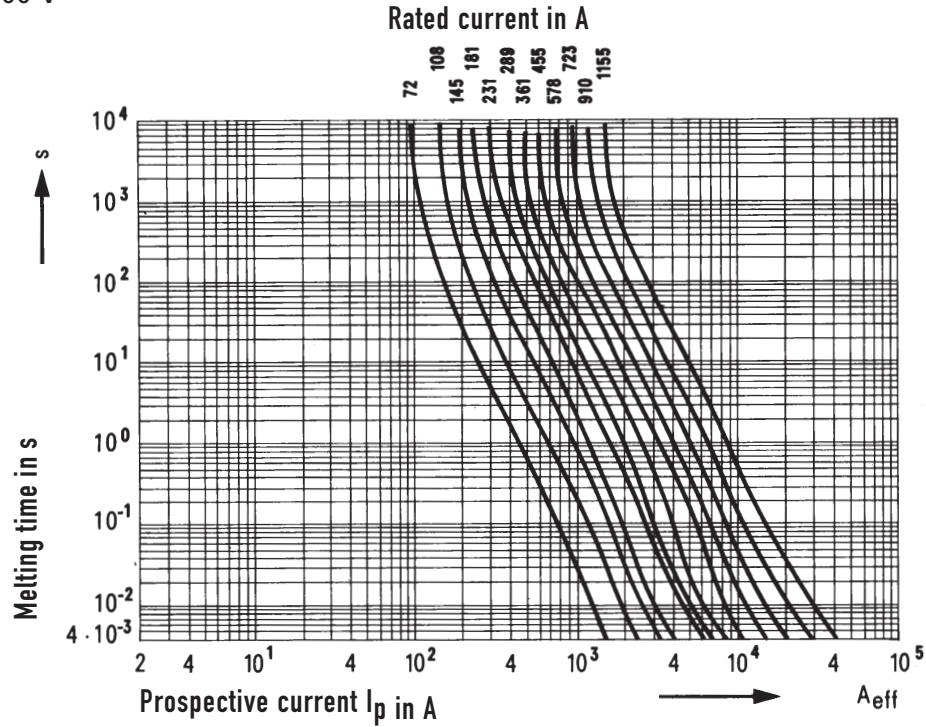

Class gTr, ~ 400 V

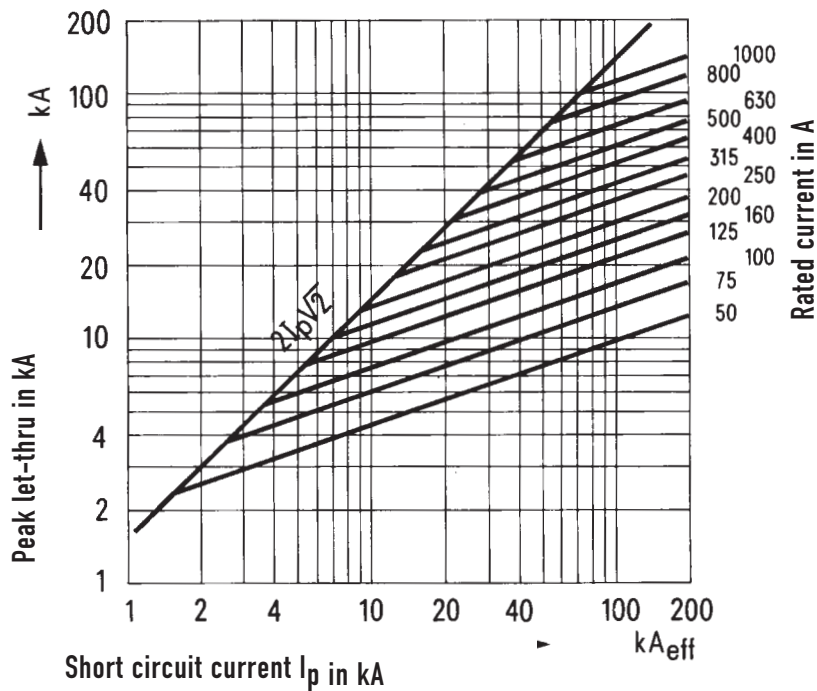

# General Purpose Fuses



NH Fuses

## 500-690V-gG

### NH Fuse-links

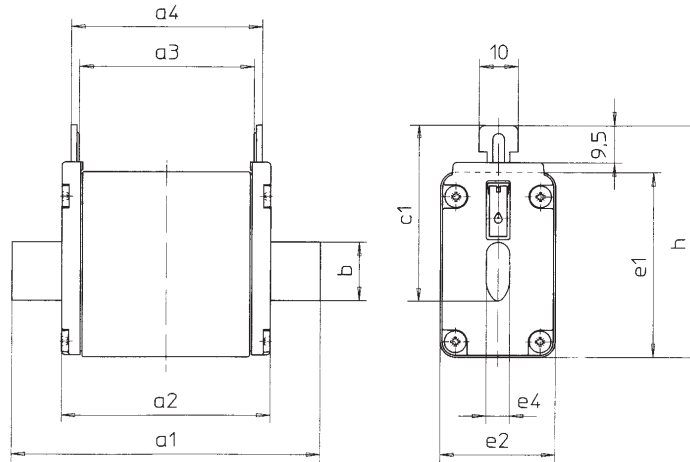

	<b>RATED In CURRENT (A)</b>	<b>a1</b>	<b>a2</b>	<b>a3</b>	<b>a4</b>	<b>b</b>	<b>c1</b>	<b>e1</b>	<b>e2</b>	<b>e4</b>	<b>h</b>
Standard 500 V and 400 V-gG with voltage-conducting grid lug (page 86/87, 89)											
SIZE 000	2-100A	79	52	45,5	49,5	15	35	40,5	20,8	6	52,5
SIZE 00	125/160A	79	52,8	45	50	15	35	47,5	29,5	6	59,5
SIZE 0	6-160A	125	66,8	61	66	15	35	47,5	29,5	6	59,5
SIZE 1	16-100A (500v),16-125A (400v)	135	70,8	63	68	15	40	47,5	29,5	6	64,5
SIZE 1	125-250A (500v),160-250A (400v)	135	70,8	63	68	20	40	52,5	39,5	6	64,5
SIZE 2	35-250A	150	72,3	63	68	20	48	52,5	39,5	6	72,5
SIZE 2	300-400A	150	72,3	63	68	26	48	60	51	6	72
SIZE 3	250-400A	150	72,3	63	68	26	60	60	51	6	83,5
SIZE 3	425-630A	150	72,3	63	68	33	60	74	70	6	86
SIZE 4	400-1250A	200	85	62	68	40	95,5	106	90	8	115,5
SIZE 4a	500-1250A	200	85	84	90	49	95,5	106	90	6	115,5
Standard 500 V and 400 V-gG (SGL version) with voltage-free grid lug (page 88, 90)											
SIZE 000	2-100A	78	53,4	45,7	49,7	15	35	40,5	20,8	6	52,5
SIZE 00	125/160A	79	53,5	44,8	49	15	35	47,5	29,5	6	59,5
SIZE 0	6-160A	125	67,5	62,5	66,7	15	35	47,5	29,5	6	59,5
SIZE 1	16-100A	135	71,5	62,8	67	15	40	47,5	29,5	6	64,5
SIZE 1	125-250A	135	73,4	63	67,2	20	40	52,5	39,5	6	64,5
SIZE 2	35-250A	150	73,4	63	67,2	20	48	52,5	39,5	6	72,5
SIZE 2	300-400A	150	73,4	63	67,2	26	48	60	51	6	72
SIZE 3	250-400A	150	73,4	63	68	26	60	60	51	6	83,5
SIZE 3	425-630A	150	73,4	63	68	33	60	74	70	6	86
Standard 500 V-gG with voltage-conducting grid lug											
SIZE 00	25-100A	79	52,8	45	50	15	35	47,5	29,5	6	59,5
SIZE 1	35-100A	135	70,8	63	68	20	40	52,5	39,5	6	64,5
SIZE 2	63-250A	150	72,3	63	68	26	48	60	51	6	72
SIZE 3	250-400A	150	72,3	63	68	33	60	74	70	6	86



# General Purpose Fuses



NH Fuses

## 500-690V-gG

Size	Rated current in A	a <sub>1</sub>	a <sub>2</sub>	a <sub>3</sub>	a <sub>4</sub>	b	c <sub>1</sub>	e <sub>1</sub>	e <sub>2</sub>	e <sub>4</sub>	h
------	--------------------	----------------	----------------	----------------	----------------	---	----------------	----------------	----------------	----------------	---

NH 500 V-gG (SGL version)  
with voltage-free grid lug

SIZE 00	25-100A	79	53,5	44,8	49	15	35	47,5	29,5	6	59,5
SIZE 1	35-100A	235	73,4	63	67,2	20	40	52,5	39,5	6	64,5
SIZE 2	63-250A	150	73,4	63	67,2	26	48	60	51	6	72
SIZE 3	250-400A	150	73,4	63	68	33	60	74	70	6	86

NH 690 V-gG with voltage-conducting grip lug

SIZE 000	2-80A	79	52	45,5	49,5	15	35	40,5	20,8	6	52,5
SIZE 00	100-125A	79	52,8	45	50	15	35	47,5	29,5	6	59,5
SIZE 0	6-160A	125	66,8	61	66	15	35	47,5	29,5	6	59,5
SIZE 1	16-100A	135	70,8	63	68	15	40	44,5	29,5	6	64,5
SIZE 1	125-200A	135	70,8	63	68	20	40	52,5	39,5	6	64,5
SIZE 2	32-250A	150	72,3	63	68	20	48	52,5	39,5	6	72,5
SIZE 2	300-355A	150	72,3	63	68	26	48	60	51	6	72
SIZE 3	250-400A	150	72,3	63	68	26	60	60	51	6	83,5
SIZE 3	425-500A	150	72,3	63	68	33	60	74	70	6	86
SIZE 4	400-800A	200	85	62	68	49	95,5	106	90	8	115,5
SIZE 4a	400-800A	200	85	84	90	49	95,5	106	90	6	115,5

NH 690 V-gG (SGL version)  
with voltage-free grip lug

SIZE 000	2-80A	78	53,4	45,7	49,7	15	35	40,5	20,8	6	52,5
SIZE 00	100-125A	79	53,5	44,8	49	15	35	47,5	29,5	6	59,5
SIZE 0	6-160A	125	67,5	62,5	66,7	15	35	47,5	29,5	6	59,5
SIZE 1	16-100A	135	71,5	62,8	67	15	40	47,5	29,5	6	64,5
SIZE 1	125-200A	135	73,4	63	67,2	20	40	52,5	39,5	6	64,5
SIZE 2	32-250A	150	73,4	63	67,2	20	48	52,5	39,5	6	72,5
SIZE 2	300-355A	150	73,4	63	67,2	26	48	60	51	6	72
SIZE 3	250-400A	150	73,4	63	68	26	60	60	51	6	83,5
SIZE 3	425-500A	150	73,4	63	68	33	60	74	70	6	86

NH 500/690 V-aM with voltage-conducting grip lug

SIZE 000	2-80A	79	52	45,5	49,5	15	35	40,5	20,8	6	52,5
SIZE 00	100-160A	79	52,8	45	50	15	35	47,5	29,5	6	59,5
SIZE 0	6-200A	125	68,8	61	66	15	35	47,5	29,5	6	59,5
SIZE 1	16-315A	135	70,8	63	68	20	40	52,5	39,5	6	64,5
SIZE 2	35-500A	150	72,3	63	68	26	48	60	51	6	72
SIZE 3	250-630A	150	72,3	63	68	33	60	74	70	6	86
SIZE 4	630-1250A	200	85	62	68	49	95,5	106	90	8	115,5

NH 400 V gTr with voltage-conducting grip lug

SIZE 2	100-250kVA	150	75	64	68	26	48	47	39	6	60
SIZE 3	100-630kVA	150	75	64	68	33	60	58	51	6	72
SIZE 4a	100-800kVA	200	85	84	90	49	95,5	106	90	6	115,5

Dimensions in mm

# General Purpose Fuses

 NH Fuses

**gG**

**500V**

LOW VOLTAGE FUSES

from 10 to 160 A

Size: 00

 BLADE-STYLE FUSES: WITH BLOWN FUSE INDICATOR

 COMPLYING WITH IEC 269.1 AND 2.1 NF EN 60269.1 & 2 NF C 63210 AND DIN 43620 STANDARDS

 DIMENSIONS

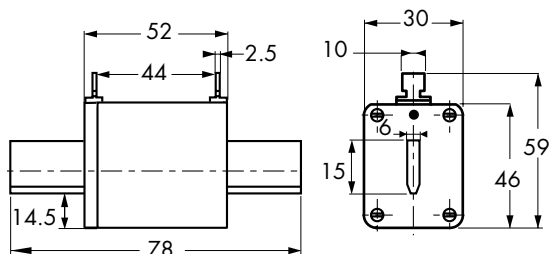

Weight: 150 g



## MAIN CHARACTERISTICS

Size	Voltage rating (V)	Current rating I <sub>N</sub> (A)	Watts loss	WITH BLOWN FUSE INDICATOR	
				Catalog Number	Reference Number
00	500 V	10	1	gG 00 L / 10	M098290
		16	1.4	gG 00 L / 16	N098291
		20	1.8	gG 00 L / 20	P098292
		25	2.1	gG 00 L / 25	Q098293
		32	3	gG 00 L / 32	R098294
		35	3	gG 00 L / 35	S098295
		40	3.3	gG 00 L / 40	T098296
		50	4.5	gG 00 L / 50	V098297
		63	6	gG 00 L / 63	X098299
		80	7	gG 00 L / 80	Z098301
		100	7.5	gG 00 L / 100	A098302
		125	13	gG 00 L / 125	B098303
		160	15	gG 00 L / 160	D098305

Accessories: Neutral link BS00 - Part # F097709  
Pull-out handle - PMP - Part # E097708

# General Purpose Fuses



NH Fuses

**gG**

**500V**

## TOTAL CLEARING I<sup>2</sup>t

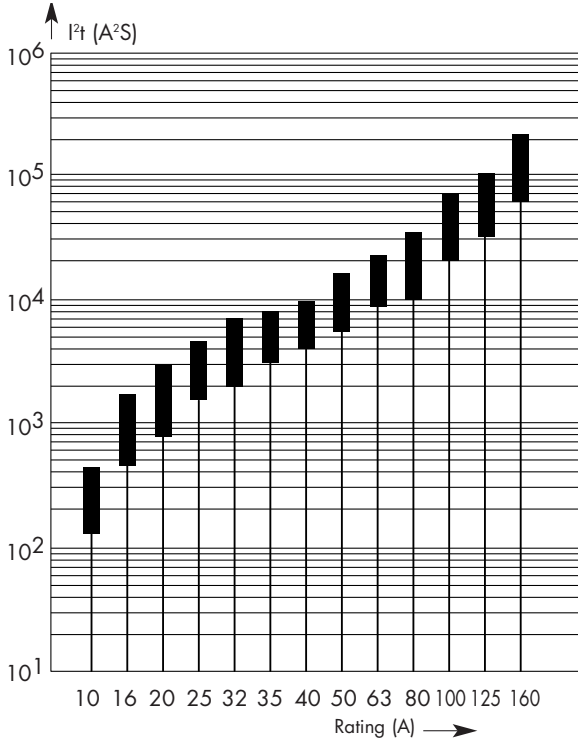

— b: total clearing I<sup>2</sup>t @ 500 V  
 — a: pre-arcing I<sup>2</sup>t

## CURRENT LIMITATION CURVES

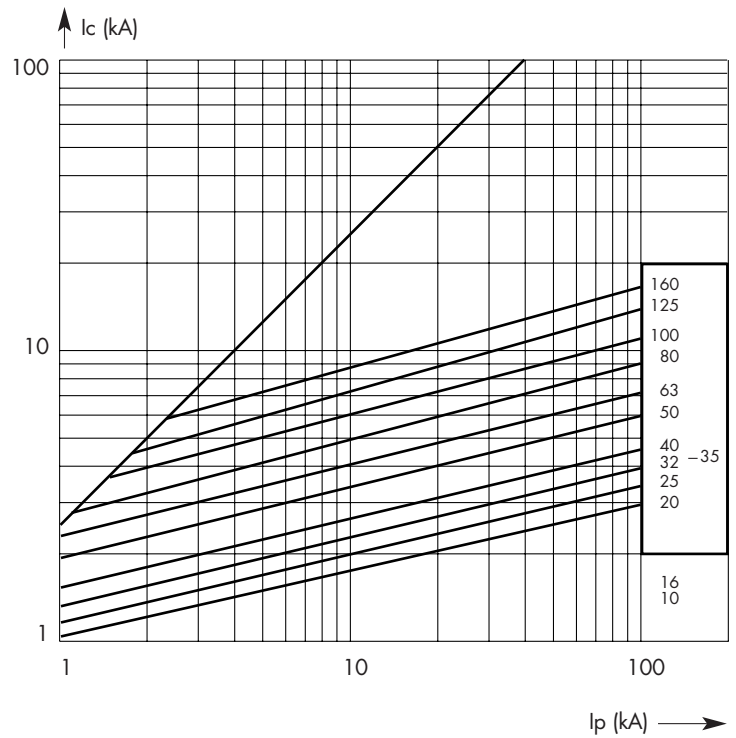

I<sub>c</sub> = Peak let-through current  
 I<sub>p</sub> = Available fault current

## TIME VS. CURRENT CHARACTERISTICS

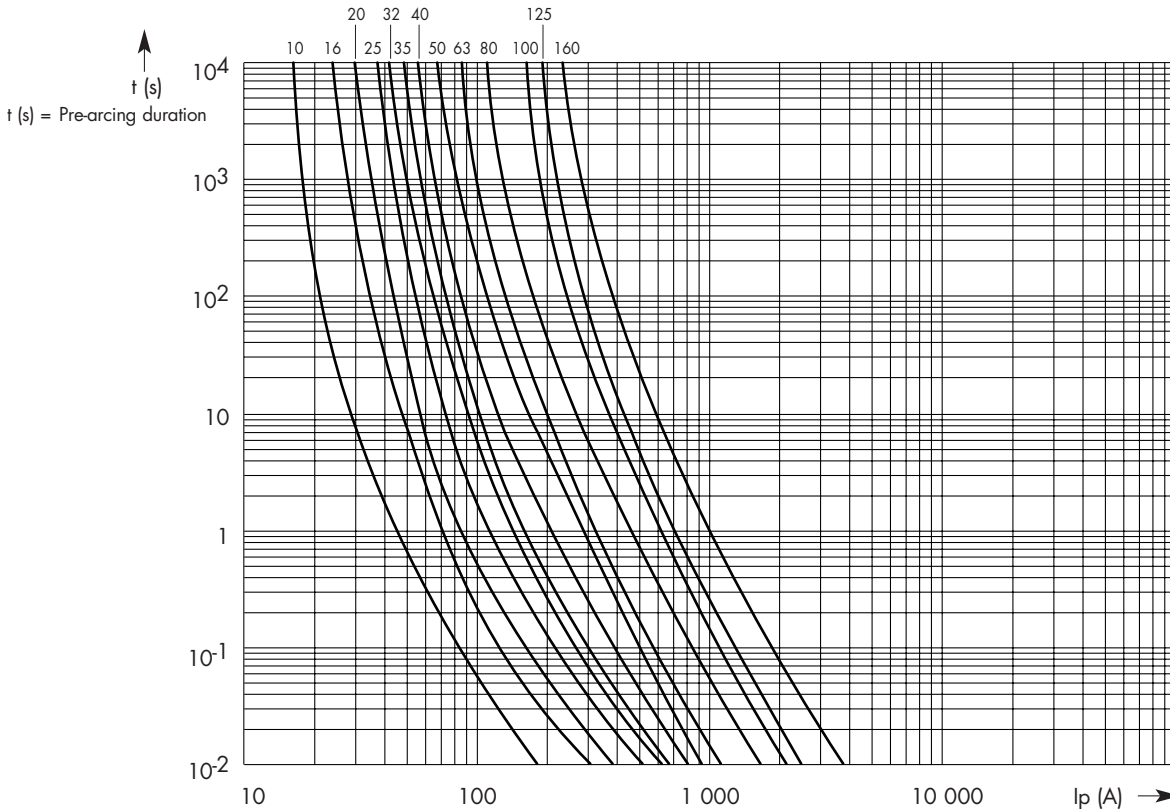

Interrupting rating  
 100 kA

I<sub>p</sub> (A) = R.M.S. available fault current

# General Purpose Fuses



**gG**

**500V**

## LOW VOLTAGE FUSES

from 40 to 250 A

Sizes: 0 - 1

BLADE-STYLE FUSES: WITH BLOWN FUSE INDICATOR OR TRIP-INDICATOR

COMPLYING WITH IEC 269.1 AND 2.1 NF EN 60269.1 & 2 NF C 63210 - 63211 AND DIN 43620

DIMENSIONS

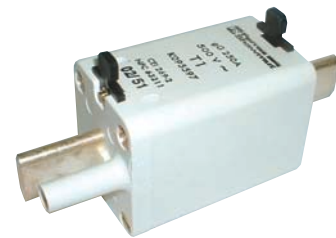
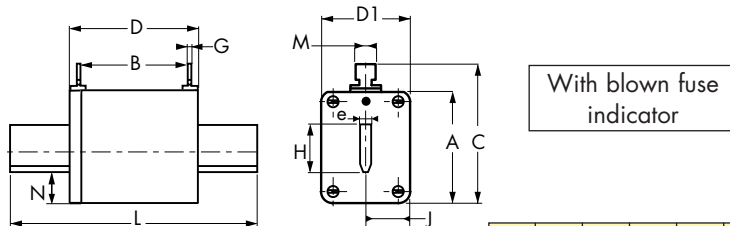
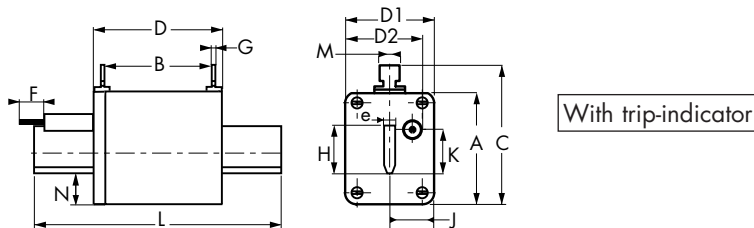

Size	A	B	C	D	D1	D2*	F*	G	H	J	K	L	M	N	e	Wgt.
0	46	62	59	67	36	39	14	2,5	15	14,5	14,5	125	10	14,5	6	230g
1	52	64	64	74	47	47	14	3	21	16	14,5	135	10	14,5	6	400g

\* For fuses with trip-indicator

Size	Voltage rating (V)	Current rating I <sub>N</sub> (A)	Watts loss	With blown fuse indicator		With trip-indicator	
				Catalog Number	Ref. Number	Catalog Number	Ref. Number
0	500 V	40	4.2	gG 0 / 40	A095013	gG 0 / 40 P	T095214
		50	5.5	gG 0 / 50	B095014	gG 0 / 50 P	V095215
		63	6.5	gG 0 / 63	C095015	gG 0 / 63 P	W095216
		80	8.5	gG 0 / 80	D095016	gG 0 / 80 P	Y095218
		100	9.5	gG 0 / 100	E095017	gG 0 / 100 P	A095220
		125	12	gG 0 / 125	F095018	gG 0 / 125 P	C095222
		160	15	gG 0 / 160	G095019	gG 0 / 160 P	G095226
		200	19	gG 0 / 200	H095020		
1	500 V	80	8.5	gG 1 / 80	K095022	gG 1 / 80 P	D095591
		100	9.6	gG 1 / 100	P095026	gG 1 / 100 P	E095592
		125	12.5	gG 1 / 125	T095030	gG 1 / 125 P	F095593
		160	15	gG 1 / 160	V095031	gG 1 / 160 P	G095594
		200	19	gG 1 / 200	W095032	gG 1 / 200 P	H095595
		250	23	gG 1 / 250	Z095035	gG 1 / 250 P	K095597

Accessories: Neutral link BS0 Reference Number G097710 - BS1 Reference Number H097711  
Pull-out handle - PMP Reference Number E097708

# General Purpose Fuses



NH Fuses

**gG**

**500V**

## TOTAL CLEARING $I^2t$

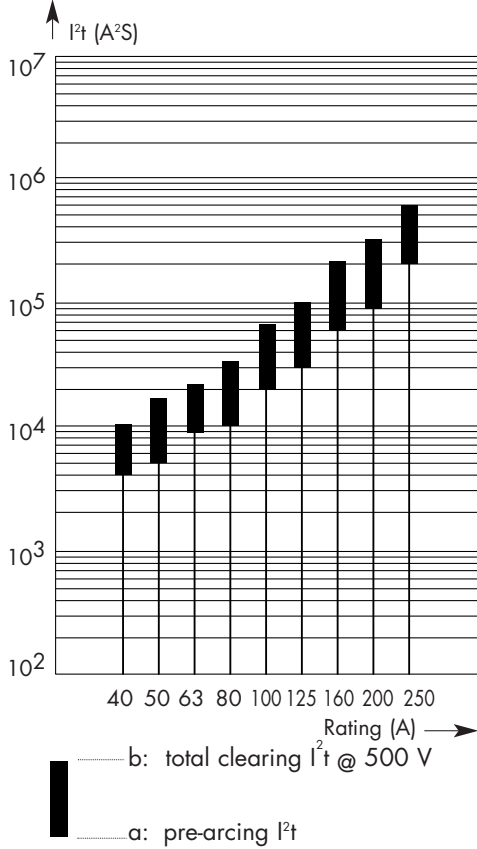

## CURRENT LIMITATION CURVES

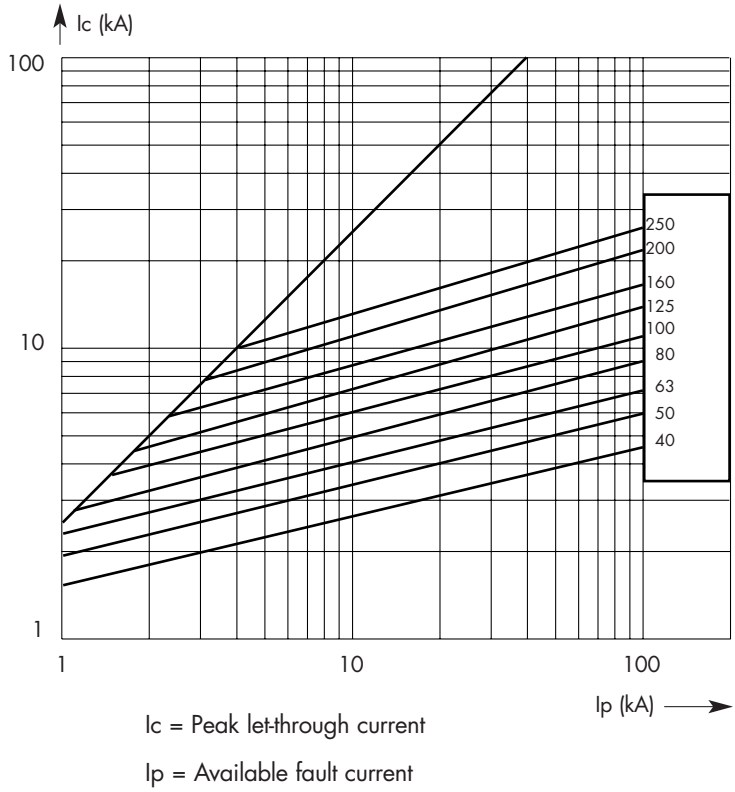

## TIME VS. CURRENT CHARACTERISTICS

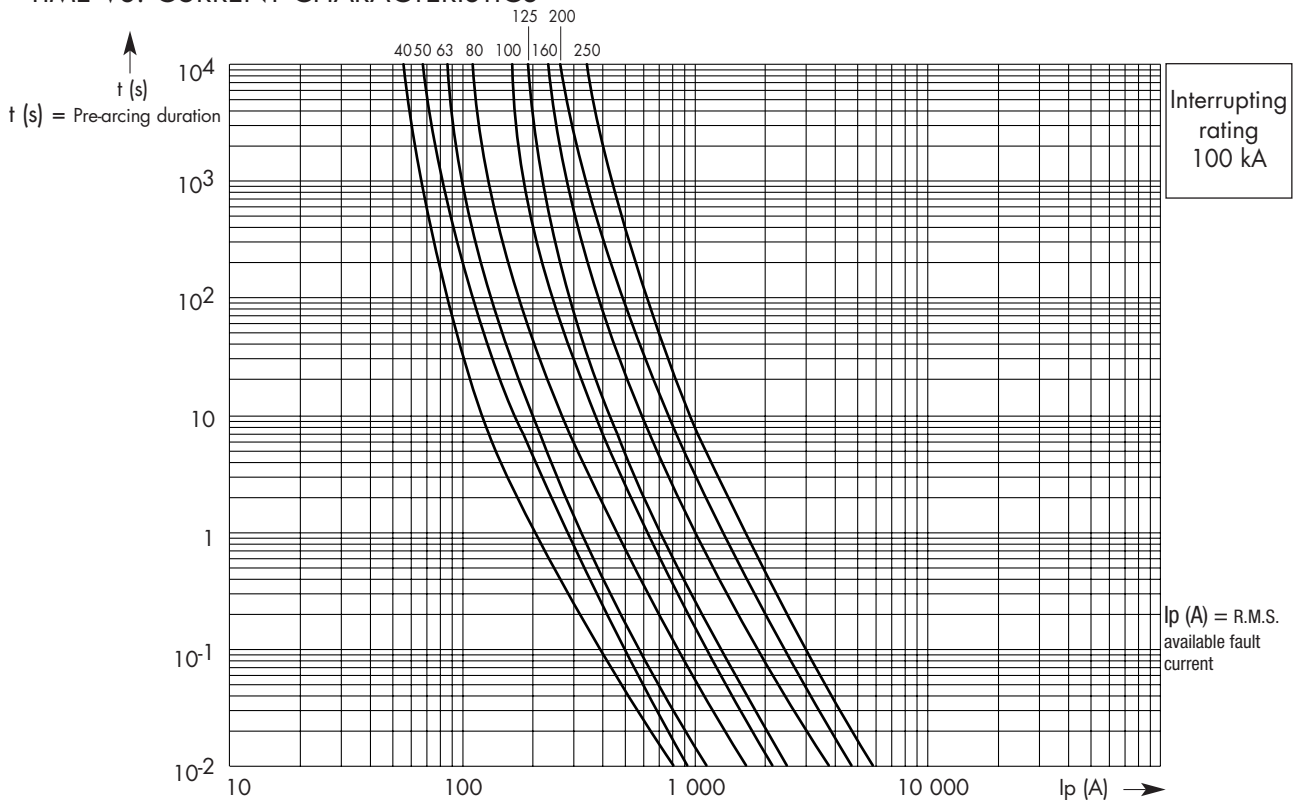



# General Purpose Fuses



**gG**

**500V**

## LOW VOLTAGE FUSES

from 125 to 630 A

Sizes: 2 - 3

BLADE-STYLE FUSES: WITH BLOWN FUSE INDICATOR OR TRIP-INDICATOR

COMPLYING WITH IEC 269.1 AND 2.1, NF EN 60269.1 & 2 NF C 63210 - 63211 AND DIN 43620

DIMENSIONS

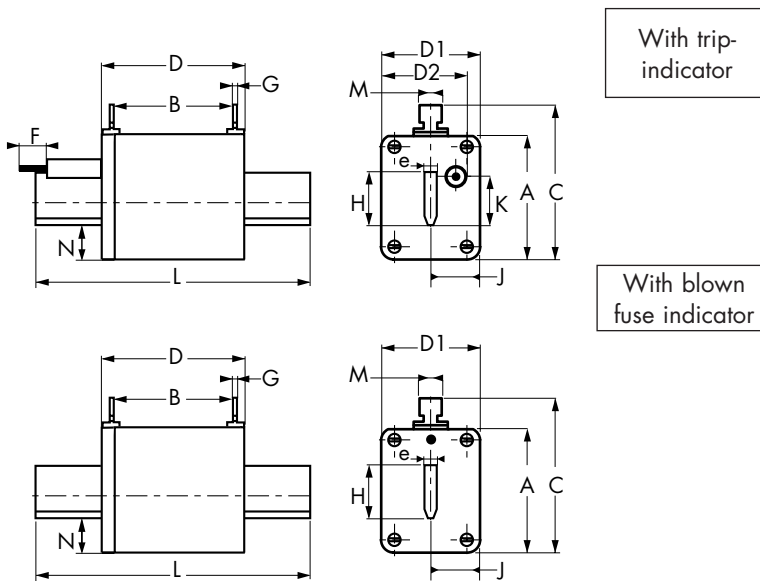

Size	A	B	C	D	D1	D2*	F*	G	H	J	K	L	M	N	e	Wgt.
2	60	64	72	74	50	50	14	3	28	19	14,5	150	10	14,5	6	590g
3	75	61	88	75	70	64	14	2,5	36	23	14,5	150	10	18	6	850g

\* For fuses with trip-indicator

Size	Voltage rating (V)	Current rating I <sub>N</sub> (A)	Watts loss	With blown fuse indicator		With trip-indicator	
				Catalog Number	Reference Number	Catalog Number	Ref. Number
2	500 V	125	12	gG 2 /125	H095066	gG 2 /125 P	X095033
		160	15	gG 2 /160	K095068	gG 2 /160 P	Y095034
		200	19	gG 2 /200	M095070	gG 2 /200 P	A095036
		250	23	gG 2 /250	G095042	gG 2 /250 P	F095041
		315	24	gG 2 /315	H095043	gG 2 /315 P	K095045
		400	33	gG 2 /400	J095044	gG 2 /400 P	M095047
3	500 V	315	24	gG 3 /315	W095170	gG 3 /315 P	N095048
		400	33	gG 3 /400	V095054	gG 3 /400 P	P095049
		500	36	gG 3 /500	W095055	gG 3 /500 P	N095071
		630	45	gG 3 /630	X095056	gG 3 /630 P	P095072

Accessories : Neutral link BS2 Reference Number J097712 - BS3 Reference Number K097713  
Pull-out handle - PMP Reference Number E097708

# General Purpose Fuses



NH Fuses

**gG**

**500V**

## TOTAL CLEARING $I^2t$

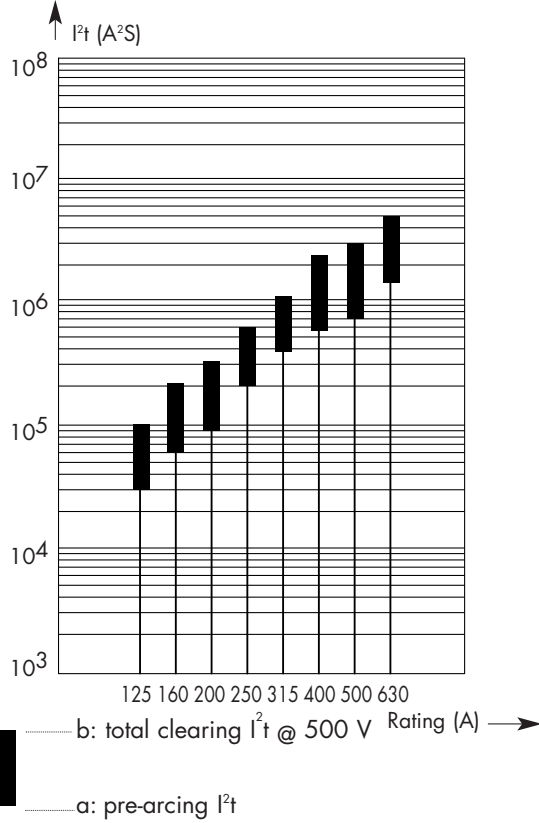

## CURRENT LIMITATION CURVES

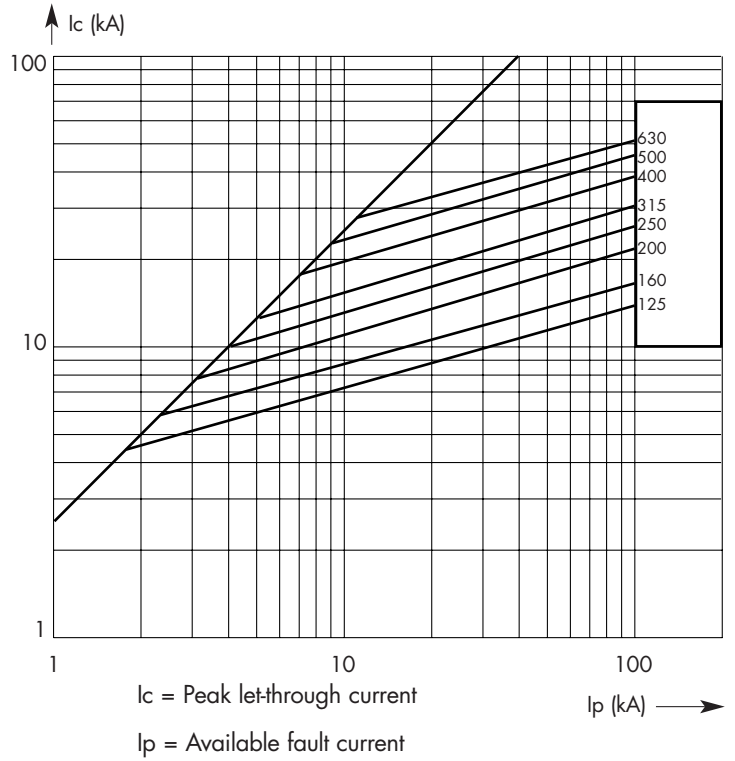

## TIME VS. CURRENT CHARACTERISTICS

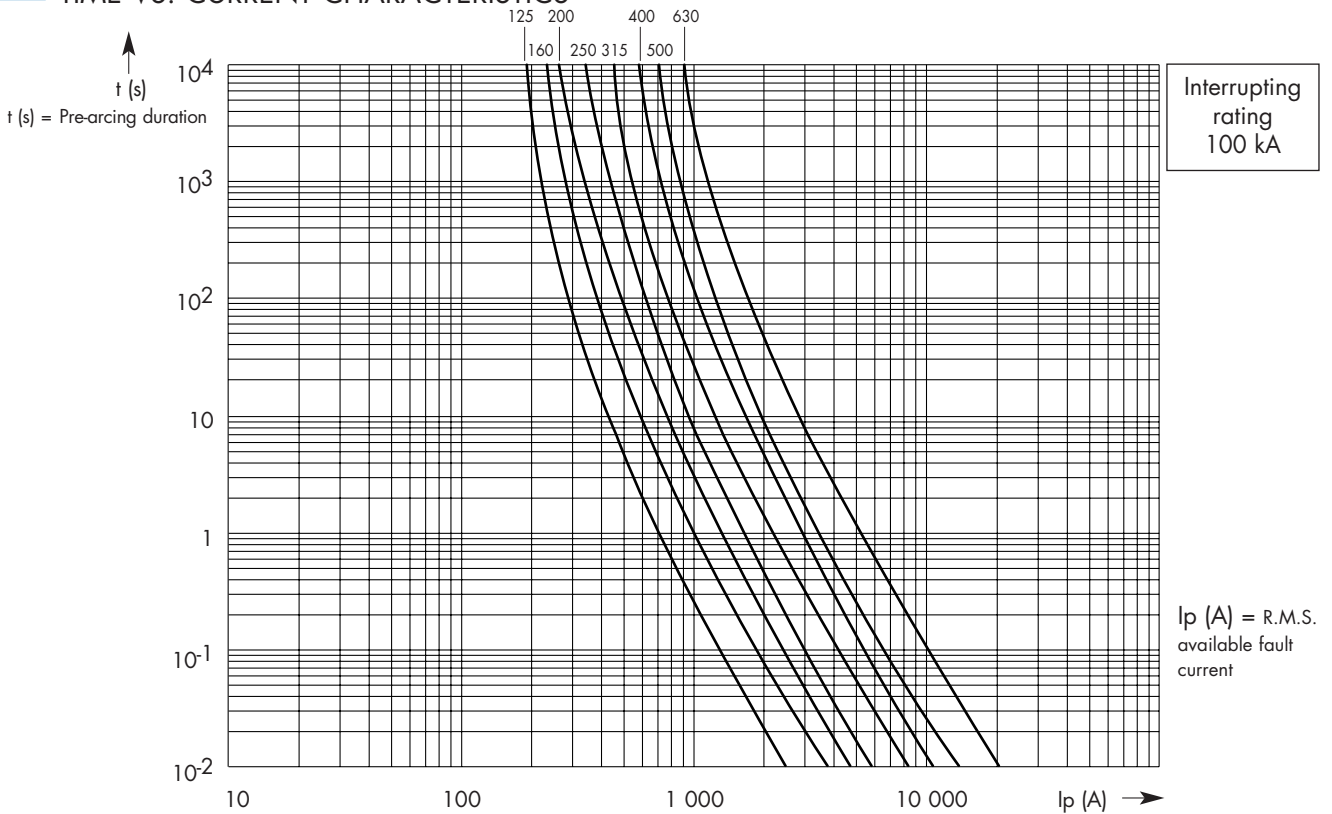

# General Purpose Fuses

 NH Fuses

**gG**

**500V**

## LOW VOLTAGE FUSES

from 630 to 1250 A

Size: 4

BLADE-STYLE FUSES: WITH BLOWN FUSE INDICATOR OR TRIP-INDICATOR

COMPLYING WITH IEC 269.1 AND 2.1, NF EN 60269.1 & 2 NF C 63210 - 63211 AND DIN 43620

DIMENSIONS

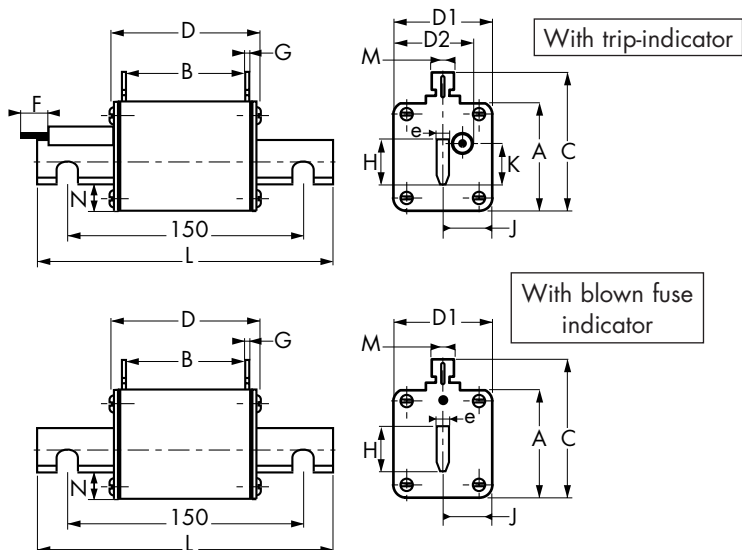

Size	A	B	C	D	D1	D2*	F*	G	H	J	K	L	M	N	e	Poids
4	107	61	119	78	90	77	14	2,5	60	27	14,5	200	10	23	8	1900g

\* For fuses with trip-indicator

Size	Voltage rating (V)	Current rating I <sub>N</sub> (A)	Watts loss	With blown fuse indicator		With trip-indicator	
				Catalog Number	Ref. Number	Catalog Number	Ref. Number
4	500 V	630	45	gG 4 / 630	S098318	gG 4 / 630 P	G088510
		800	51	gG 4 / 800	T098319	gG 4 / 800 P	J088512
		1000	77	gG 4 /1000	V098320	gG 4 /1000 P	K088513
		1250	80	gG 4 /1250	W098321	gG 4 /1250 P	L088514

Accessories: Neutral link - BS4 Reference Number M097715  
Pull-out handle - PMP Reference Number E097708

# General Purpose Fuses



NH Fuses

**gG**

**500V**

## TOTAL CLEARING $I^2t$

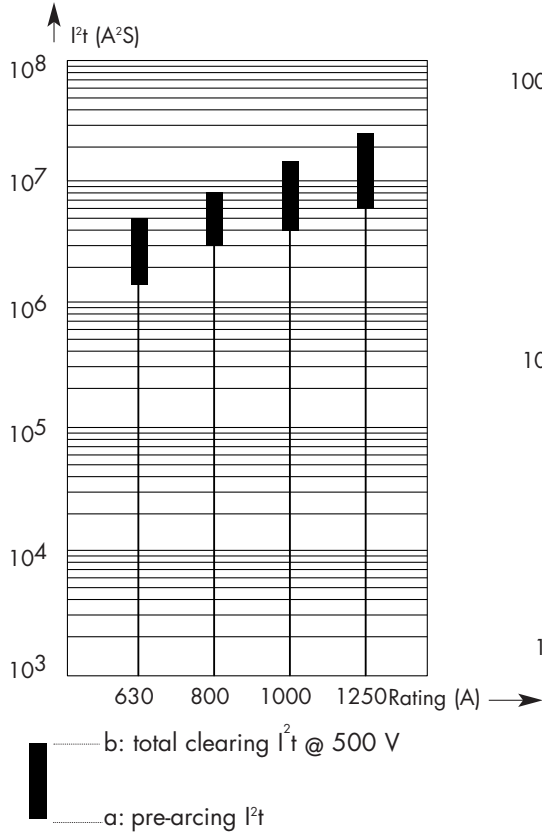

## CURRENT LIMITATION CURVES

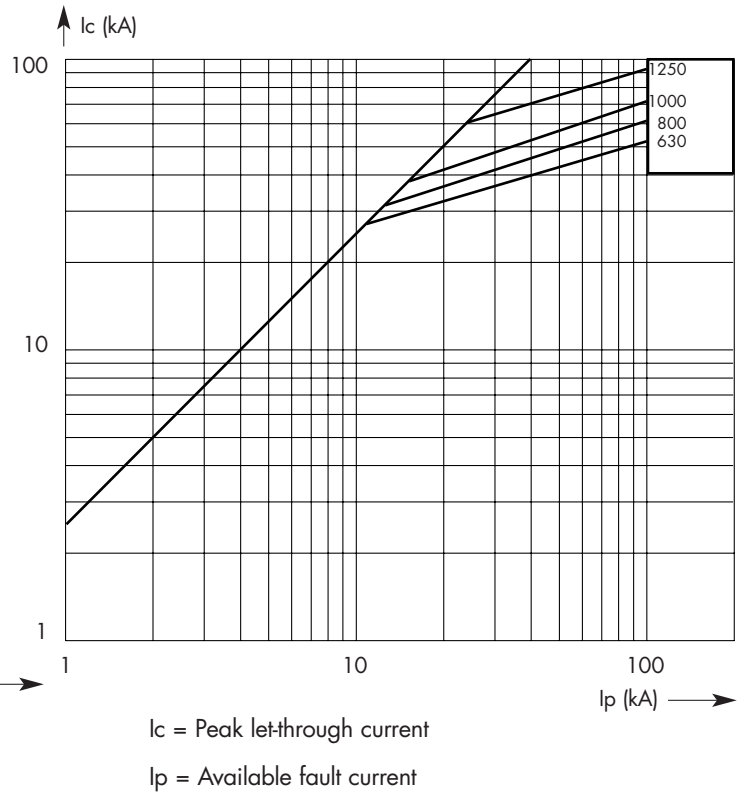

## TIME VS. CURRENT CHARACTERISTICS

