

# Solid State Relays Industrial, 1-Phase ZS (IO) w. LED and Built-in Varistor Types RM 23, RM 40, RM 48, RM 60



- Zero switching (RM1A) or instant-on switching (RM1B) AC Solid State Relay
- Direct copper bonding (DCB) technology
- LED indication
- Built-in varistor
- Clip-on IP 20 protection cover
- Self-lifting terminals
- Housing free of moulding mass
- 2 input ranges: 3-32\* VDC and 20-280VAC/22-48VDC
- Operational ratings: Up to 100AACrms and 600VACrms
- Blocking voltage: Up to 1400V<sub>p</sub>
- Opto-isolation: > 4000VACrms



## Product Description

The industrial, 1-phase relay with antiparallel thyristor output is the most widely used industrial SSR due to its multiple application possibilities. The relay can be used for resistive, inductive and capacitive loads. The zero switching relay switches ON when the sinusoidal curve crosses zero and switches OFF when the current crosses zero.

The instant-on relay with DC control input can be used for phase control. The built-in varistor secures transient protection for the heavy industrial applications, and the LED indicates the status of the control input. The clip-on cover is securing touch protection to IP 20. Protected output terminals can handle cables up to 16mm<sup>2</sup>.

## Ordering Key

**RM 1 A 23 D 25**

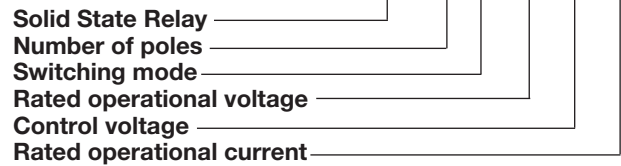

## Type Selection

Switching mode	Rated operational voltage	Control voltage	Rated operational current
A: Zero Switching (ZC) B: Instant-on switching (IO) (DC Control only)	23: 230VACrms 40: 400VACrms 48: 480VACrms 60: 600VACrms	A: 20-280VAC / 22-48VDC D: 3-32VDC* *4 to 32VDC for 400, 480 and 600VAC types *4 to 32VDC for RM1B types	25: 25AACrms 50: 50AACrms 75: 75AACrms 100: 100AACrms

## Selection Guide

Rated operational voltage	Blocking voltage	Control voltage	Rated operational current with suitable heatsink			
			25A	50A	75A	100A
230VACrms	650V <sub>p</sub>	3 - 32VDC	<b>RM1A23D25</b>	<b>RM1A23D50</b>	<b>RM1A23D75</b>	<b>RM1A23D100</b>
		20 to 280VAC 22 to 48VDC	<b>RM1A23A25</b>	<b>RM1A23A50</b>	<b>RM1A23A75</b>	<b>RM1A23A100</b>
400VACrms	850V <sub>p</sub>	4 - 32VDC	<b>RM1A40D25</b>	<b>RM1A40D50</b>	<b>RM1A40D75</b>	<b>RM1A40D100</b>
		20 to 280VAC 22 to 48VDC	<b>RM1A40A25</b>	<b>RM1A40A50</b>	<b>RM1A40A75</b>	<b>RM1A40A100</b>
480VACrms	1200V <sub>p</sub>	4 - 32VDC	<b>RM1A48D25</b>	<b>RM1A48D50</b>	<b>RM1A48D75</b>	<b>RM1A48D100</b>
		20 to 280 VAC 22 to 48VDC	<b>RM1A48A25</b>	<b>RM1A48A50</b>	<b>RM1A48A75</b>	<b>RM1A48A100</b>
600VACrms	1400V <sub>p</sub>	4 - 32VDC	<b>RM1A60D25</b>	<b>RM1A60D50</b>	<b>RM1A60D75</b>	<b>RM1A60D100</b>
		20 to 280VAC 22 to 48VDC	<b>RM1A60A25</b>	<b>RM1A60A50</b>	<b>RM1A60A75</b>	<b>RM1A60A100</b>

## General Specifications

	RM1.23...	RM1.40...	RM1.48...	RM1.60...
<b>Operational voltage range</b>				
RM1A...	24 to 265VACrms	42 to 440VACrms	42 to 530VACrms	42 to 660VACrms
RM1B...	42 to 265VACrms	42 to 440VACrms	42 to 530VACrms	42 to 660VACrms
<b>Blocking voltage</b>	650V <sub>p</sub>	850V <sub>p</sub>	1200V <sub>p</sub>	1400V <sub>p</sub>
<b>Zero voltage turn-on</b>	≤ 10V	≤ 10V	≤ 10V	≤ 10V
<b>Operational frequency range</b>	45 to 65Hz	45 to 65Hz	45 to 65Hz	45 to 65Hz
<b>Power factor</b>	> 0.5 @ 230VACrms	> 0.5 @ 400VACrms	> 0.5 @ 480VACrms	> 0.5 @ 600VACrms
<b>Approvals</b>	UR, cUR, CSA, CCC, EAC	UR, cUR, CSA, CCC, EAC	UR, cUR, CSA, CCC, EAC	UR, cUR, CSA, CCC, EAC
<b>CE-marking</b>	Yes	Yes	Yes	Yes *
<b>Isolation</b>				
<b>Input to Output</b>	4000 Vrms	4000 Vrms	4000 Vrms	4000 Vrms
<b>input and Output to case</b>	4000 Vrms	4000 Vrms	4000 Vrms	4000 Vrms

\* Heatsink must be connected to ground

## Input Specifications

	RM1...D..	RM1...A..
<b>Control voltage range</b>		
RM1A23...	3 - 32VDC	20 - 280VAC, 22 - 48VDC
RM1A40... RM1A48... RM1A60...	4 - 32VDC	20 - 280VAC, 22 - 48VDC
RM1B...	4 - 32VDC	-
<b>Pick-up voltage @ Ta = 25°C</b>		
RM1A23...	2.5VDC	18VAC/DC
RM1A40... RM1A48... RM1A60...	3.5VDC	18VAC/DC
RM1B ...	3.5VDC	-
<b>Reverse voltage</b>	32VDC	-
<b>Drop out voltage</b>	1.2VDC	6VAC/DC
<b>Input current @ max input voltage</b>		
RM1A	≤12 mA	≤ 20mA
RM1B	≤15 mA	-
<b>Response time pick-up</b>		
RM1A	≤1/2 cycle	≤ 12ms
RM1B	≤0.1ms	-
<b>Response time drop-out</b>	≤1/2 cycle	≤ 40ms

## Output Specifications

	RM1....25	RM....50	RM1....75	RM1....100
<b>Rated operational current</b>				
AC51 @ Ta=25°C	25Arms	50Arms	75Arms	100Arms
AC53a @ Ta=25°C	5Arms	15Arms	20Arms	30Arms
<b>Min. operational current</b>	150mA	250mA	400mA	500mA
<b>Rep. overload current t=1 s</b>	< 55AACrms	< 125AACrms	< 150AACrms	< 200AACrms
<b>Non-rep. surge current t=10 ms</b>	325A <sub>p</sub>	600A <sub>p</sub>	1150A <sub>p</sub>	1900A <sub>p</sub>
<b>Off-state leakage current @ rated voltage and frequency</b>	< 3mArms	< 3mArms	< 3mArms	< 3mArms
<b>I<sup>2</sup>t for fusing t=10 ms</b>	< 525A <sup>2</sup> s	< 1800A <sup>2</sup> s	< 6600A <sup>2</sup> s	<18000A <sup>2</sup> s
<b>Critical dV/dt off-state min.</b>	1000V/μs	1000V/μs	1000V/μs	1000V/μs
<b>Endurance testing acc. to UL508</b>	100,000 cycles	100,000 cycles	100,000 cycles	6,000 cycles

Note: UL requirement for General Use Endurance testing is 6,000 cycles



## Motor Ratings\*: HP (UL508)

	230VAC	400VAC	480VAC	600VAC
RM1..25	1.5HP	3HP	3HP	5HP
RM1..50	3HP	5HP	7.5HP	10HP
RM1..75	5HP	10HP	10HP	15HP
RM1..100	7.5HP	15HP	20HP	25HP

\* with suitable heatsink

## Electromagnetic Compatibility

<b>EMC Immunity</b>	EN60947-4-3	<b>Radiated Radio Frequency Immunity</b>	IEC/EN 61000-4-3
<b>Electrostatic Discharge (ESD) Immunity</b>	IEC/EN 61000-4-2	10V/m, 80 - 1000 MHz	Performance Criteria 1
Air discharge, 8kV	Performance Criteria 2	10V/m, 1.4 - 2.0GHz	Performance Criteria 1
Contact, 4kV	Performance Criteria 2	3 V/m, 2.0 - 2.7GHz	Performance Criteria 1
<b>Electrical Fast Transient (Burst) Immunity</b>	IEC/EN 61000-4-4	<b>Conducted Radio Frequency Immunity</b>	IEC/EN 61000-4-6
Output: 2kV, 5kHz	Performance Criteria 1	10V/m, 0.15 - 80 MHz	Performance Criteria 1
Input: 1kV, 5kHz	Performance Criteria 1	<b>Voltage Dips Immunity</b>	IEC/EN 61000-4-11
<b>Electrical Surge Immunity</b>	IEC/EN 61000-4-5	0% for 0.5, 1 cycle	Performance Criteria 2
Output, line to line, 1kV	Performance Criteria 2	40% for 10 cycles	Performance Criteria 2
Output, line to earth, 2kV	Performance Criteria 2	70% for 25 cycles	Performance Criteria 2
Input, line to line, 1kV	Performance Criteria 2	80% for 250 cycles	Performance Criteria 2
Input, line to earth, 2kV	Performance Criteria 2	<b>Voltage Interruptions Immunity</b>	IEC/EN 61000-4-11
		0% for 5000ms	Performance Criteria 2
<b>EMC Emission</b>	EN60947-4-3	<b>Radio Interference Field Emission (Radiated)</b>	IEC/EN 55011
<b>Radio Interference Voltage Emission (Conducted)</b>	IEC/EN 55011	30 - 1000MHz	Class B
0.15 - 30MHz	Class A (industrial) with filters		
	IEC/EN 60947-4-3		
	Class A (no filtering needed up to 75AAC)		

**Notes:**

- Control input lines must be installed together to maintain products' susceptibility to Radio Frequency interference.
- Performance Criteria 1: No degradation of performance or loss of function is allowed when the product is operated as intended.
- Performance Criteria 2: During the test, degradation of performance or partial loss of function is allowed. However, when the test is complete the product should return operating as intended by itself.
- Performance Criteria 3: Temporary loss of function is allowed, provided the function can be restored by manual operation of the controls.





## Thermal Specifications

	RM1...25	RM1...50	RM1.60.50	RM1...75	RM1...100
Operating temperature range	-20° to 70°C	-20° to 70°C	-20° to 70°C	-20° to 70°C	-20° to 70°C
Storage temperature range	-40° to 100°C	-40° to 100°C	-40° to 100°C	-40° to 100°C	-40° to 100°C
Junction temperature	≤ 125°C	≤ 125°C	≤ 125°C	≤ 125°C	≤ 125°C
R <sub>th</sub> junction to case	≤ 0.80°C/W	≤ 0.50°C/W	≤ 0.72°C/W	≤ 0.35°C/W	≤ 0.30°C/W
R <sub>th</sub> junction to ambient	≤ 20.0°C/W	≤ 20.0°C/W	≤ 20.0°C/W	≤ 20.0°C/W	≤ 20.0°C/W

## Housing Specifications

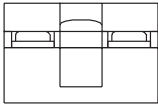
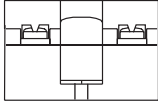
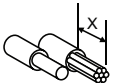
<b>Weight</b> 25A, 50A 75A, 100A	Approx. 60g Approx. 100g	<b>Relay</b> Mounting screws Mounting torque	M5 1.5-2.0Nm
<b>Baseplate</b> 25A, 50A 75A, 100A	Aluminium Copper, nickel-plated	<b>Control terminal</b> Mounting screws Mounting torque	M3 x 9 0.5Nm
<b>Potting compound</b>	None	<b>Power terminal</b> Mounting screws Mounting torque	M5 x 9 2.4Nm

## Connection Specifications

Connection terminals		L1, T1		A1, A2	
					
Stripping length (X)		12 mm		8 mm	
Connection Type		M5 screw with captivated washer		M3 screw with captivated washer	
Rigid (solid & stranded) UR rated data		1x 2.5 - 6.0 mm <sup>2</sup> 1x 14 - 10 AWG	2x 2.5 - 6.0 mm <sup>2</sup> 2x 14 - 10 AWG	1x 0.5 - 2.5 mm <sup>2</sup> 1x 18 - 12 AWG	2x 0.5 - 2.5 mm <sup>2</sup> 2x 18 - 12 AWG
Flexible with end sleeve		1x 1.0 - 4.0 mm <sup>2</sup> 1x 18 - 12 AWG	2x 1.0 - 2.5 mm <sup>2</sup> 2x 2.5 - 4.0 mm <sup>2</sup> 2x 18 - 14 AWG 2x 14 - 12 AWG	1x 0.5 - 2.5 mm <sup>2</sup> 1x 18 - 12 AWG	2x 0.5 - 2.5 mm <sup>2</sup> 2x 18 - 12 AWG
Flexible without end sleeve		1x 1.0 - 6.0 mm <sup>2</sup> 1x 18 - 10 AWG	2x 1.0 - 2.5 mm <sup>2</sup> 2x 2.5 - 6.0 mm <sup>2</sup> 2x 18 - 14 AWG 2x 14 - 10 AWG		
Torque specification		Pozidrive 2 2.4 Nm (21.2 lb-in)		Pozidrive 1 0.5 Nm (4.4 lb-in)	
Aperture for termination lug		12 mm		7.5 mm	

## Functional Diagram

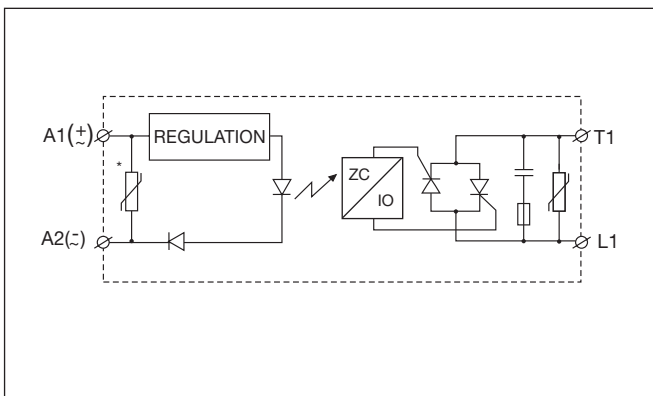

\* Varistor across input applies to AC control versions only.

## Dimensions

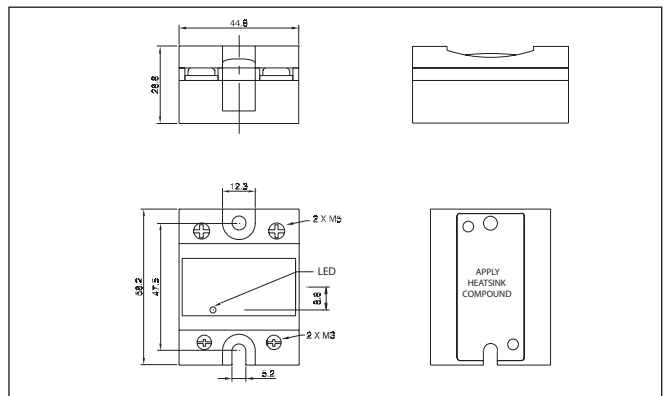

All dimensions in mm

## Connection Diagram

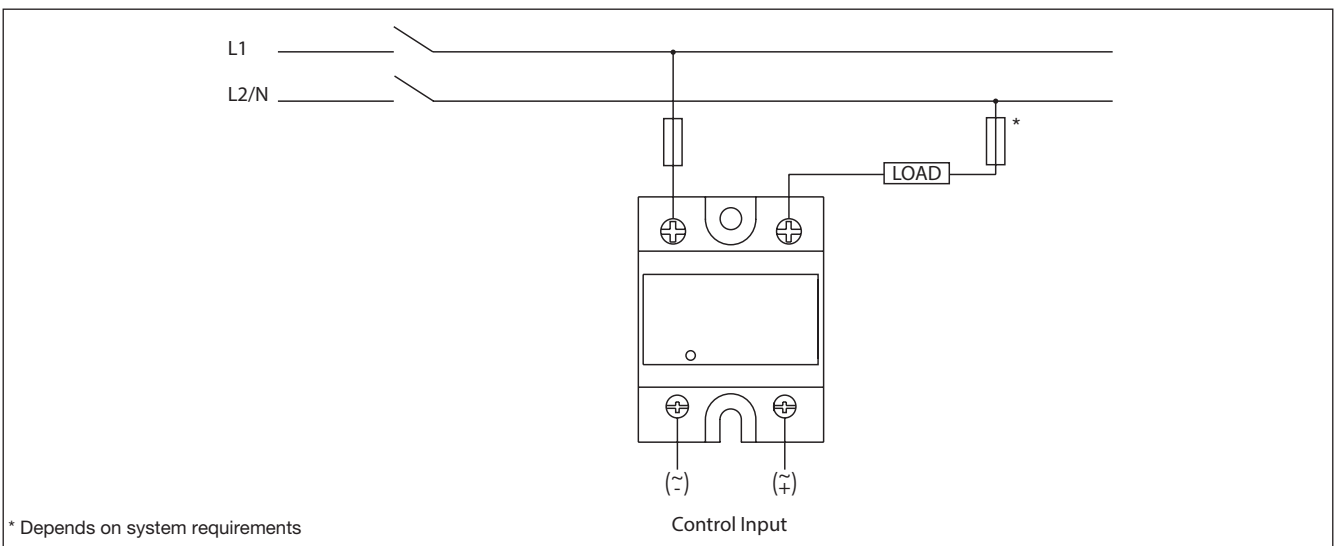

\* Depends on system requirements

## Output Power Dissipation

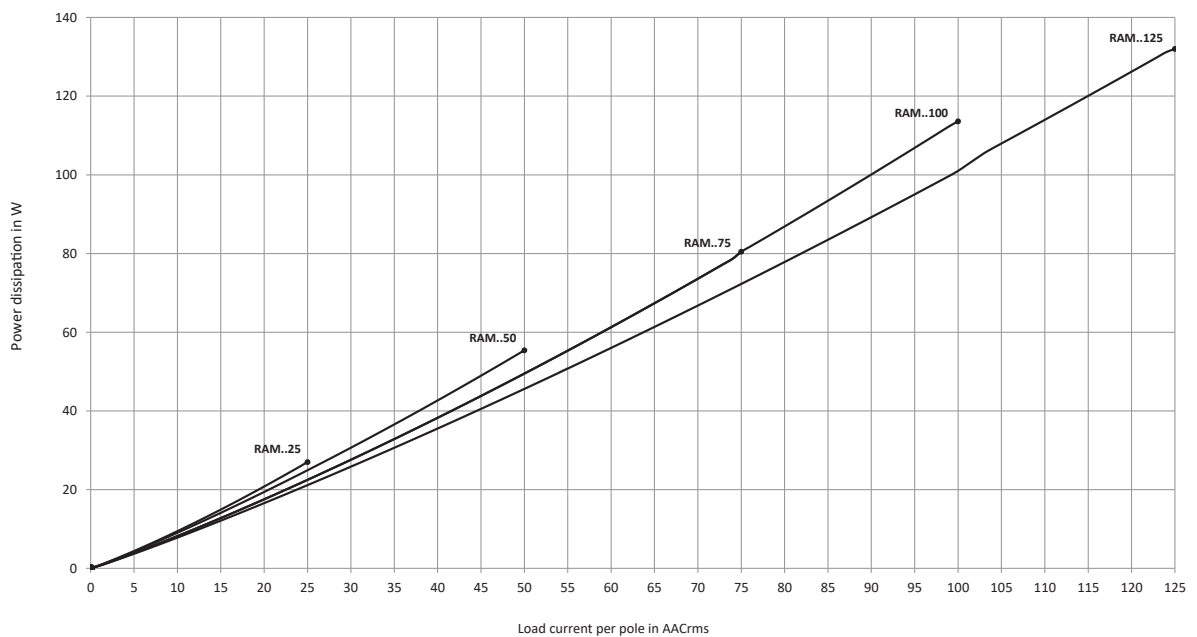



## Heatsink Dimensions (load current versus ambient temperature)

### RM..25

Load current [A]	Thermal resistance [°C/W]					
	20	30	40	50	60	70
25.0	2.70	2.34	1.98	1.61	1.25	0.89
22.5	3.10	2.69	2.28	1.86	1.45	1.04
20.0	3.61	3.13	2.65	2.18	1.70	1.23
17.5	4.26	3.70	3.14	2.59	2.03	1.47
15.0	5.14	4.47	3.80	3.14	2.47	1.80
12.5	6.38	5.56	4.73	3.91	3.09	2.27
10.0	8.25	7.19	6.14	5.08	4.02	2.97
7.5	11.4	9.94	8.49	7.04	5.59	4.14
5.0	17.7	15.4	13.2	11.0	8.74	6.51
2.5	-	-	-	-	18.2	13.6

### RM..50

Load current [A]	Thermal resistance [°C/W]					
	20	30	40	50	60	70
50.0	1.03	0.86	0.70	0.53	0.37	0.20
45.0	1.27	1.32	0.90	0.71	0.52	0.33
40.0	1.54	1.59	1.10	0.89	0.67	0.45
35.0	1.85	1.95	1.34	1.08	0.82	0.57
30.0	2.26	2.47	1.65	1.34	1.03	0.72
25.0	2.85	3.24	2.08	1.70	1.32	0.94
20.0	3.73	3.24	2.75	2.26	1.77	1.27
15.0	5.22	4.54	3.86	3.19	2.51	1.83
10.0	8.21	7.16	6.11	5.05	4.00	2.95
5.0	17.2	15.0	12.9	10.7	8.51	6.33

Junction to ambient thermal resistance, $R_{th\ j-a}$	< 20.0	°C/W
Junction to case thermal resistance, $R_{th\ j-c}$	< 0.80	°C/W
Case to heatsink thermal resistance, $R_{th\ c-s^2}$	< 0.20	°C/W
Maximum allowable case temperature	100	°C
Maximum allowable junction temperature	125	°C

Junction to ambient thermal resistance, $R_{th\ j-a}$	< 20.0	°C/W
Junction to case thermal resistance, $R_{th\ j-c}$	< 0.50	°C/W
Case to heatsink thermal resistance, $R_{th\ c-s^2}$	< 0.20	°C/W
Maximum allowable case temperature	100	°C
Maximum allowable junction temperature	125	°C

### RM1.60..50

Load current [A]	Thermal resistance [°C/W]					
	20	30	40	50	60	70
50.0	0.99	0.81	0.63	0.44	0.26	0.08
45.0	1.28	1.07	0.86	0.65	0.44	0.23
40.0	1.64	1.40	1.15	0.91	0.67	0.42
35.0	2.11	1.82	1.54	1.25	0.96	0.67
30.0	2.60	2.25	1.90	1.55	1.20	0.85
25.0	3.30	2.86	2.43	1.99	1.55	1.11
20.0	4.36	3.79	3.22	2.65	2.08	1.51
15.0	6.1	5.4	4.6	3.77	2.97	2.18
10.0	9.76	8.52	7.3	6.0	4.8	3.54
5.0	--	--	15.47	12.85	10.24	7.6

### RM..75

Load current [A]	Thermal resistance [°C/W]					
	20	30	40	50	60	70
75.0	0.91	0.78	0.65	0.52	0.39	0.26
67.5	1.10	0.96	0.81	0.66	0.51	0.36
60.0	1.34	1.17	1.00	0.83	0.66	0.49
52.5	1.60	1.40	1.20	1.00	0.80	0.60
45.0	1.93	1.68	1.44	1.20	0.96	0.72
37.5	2.38	2.08	1.78	1.49	1.9	0.89
30.0	3.06	2.68	2.30	1.91	1.53	1.15
22.5	4.21	3.68	3.16	2.63	2.10	1.58
15.0	6.51	5.70	4.88	4.07	3.26	2.44
7.5	13.5	11.77	10.09	8.41	6.73	5.04

Junction to ambient thermal resistance, $R_{th\ j-a}$	< 20.0	°C/W
Junction to case thermal resistance, $R_{th\ j-c}$	< 0.35	°C/W
Case to heatsink thermal resistance, $R_{th\ c-s^2}$	< 0.10	°C/W
Maximum allowable heatsink temperature	100	°C
Maximum allowable junction temperature	125	°C

Junction to ambient thermal resistance, $R_{th\ j-a}$	< 20.0	°C/W
Junction to case thermal resistance, $R_{th\ j-c}$	< 0.35	°C/W
Case to heatsink thermal resistance, $R_{th\ c-s^2}$	< 0.10	°C/W
Maximum allowable heatsink temperature	100	°C
Maximum allowable junction temperature	125	°C

## Heatsink Dimensions (load current versus ambient temperature) cont.

### RM..100

Load current [A]	Thermal resistance [°C/W]					
	20	30	40	50	60	70
100.0	0.54	0.45	0.36	0.27	0.18	0.09
90.0	0.68	0.58	0.47	0.37	0.27	0.17
80.0	0.86	0.74	0.62	0.50	0.38	0.26
70.0	1.08	0.94	0.80	0.66	0.52	0.38
60.0	1.37	1.20	1.03	0.85	0.68	0.51
50.0	1.70	1.49	1.28	1.06	0.85	0.64
40.0	2.21	1.93	1.66	1.38	1.10	0.83
30.0	3.06	2.68	2.30	1.91	1.53	1.15
20.0	4.78	4.18	3.59	2.99	2.39	1.79
10.0	9.98	8.73	7.49	6.24	4.99	3.74

Ambient temp. [°C]

Junction to ambient thermal resistance, $R_{th\ j-a}$	< 20.0	°C/W
Junction to case thermal resistance, $R_{th\ j-c}$	< 0.35	°C/W
Case to heatsink thermal resistance, $R_{th\ c-s^2}$	< 0.10	°C/W
Maximum allowable heatsink temperature	100	°C
Maximum allowable junction temperature	125	°C

2. Thermal resistance case to heatsink valves are applicable upon application of a fine layer of silicon based thermal paste HTS02S from Electrolube between SSR and heatsink.

## Heatsink Selection

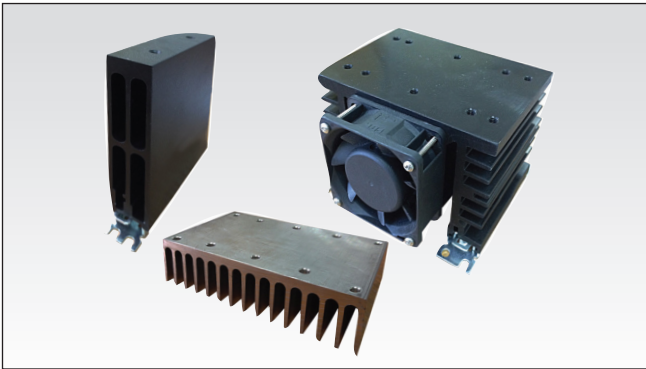

Heatsink Range Overview:

[http://www.productselection.net/PDF/UK/ssr\\_accessories.pdf](http://www.productselection.net/PDF/UK/ssr_accessories.pdf)

Heatsink Selector Tool:

<http://www.productselection.net/heatsink/heatsinkselector.php?LANG=UK>

## Ordering Key

**RHS..**

- Heatsinks and fans
- 5.40°C/W to 0.12°C/W thermal resistance
- DIN, panel or thru wall mounting
- Single or multiple SSR mounting

## Short Circuit Protection

Protection Co-ordination, Type 1 vs. Type 2:

Type 1 protection implies that after a short circuit, the device under test will no longer be in a functioning state. In type 2 co-ordination the device under test will still be functional after the short circuit. In both cases, however, the short circuit has to be interrupted. The fuse between enclosure and supply shall not open. The door or cover of the enclosure shall not be blown open. There shall be no damage to conductors of terminals and the conductors shall not separate from terminals. There shall be no breakage or cracking of insulating bases to the extent that the integrity of the mounting of live parts is impaired. Discharge of parts or any risk of fire shall not occur.

The product variants listed in the table hereunder are suitable for use on a circuit capable of delivering not more than 65,000A rms Symmetrical Amperes, 600Volts maximum when protected by fuses. Tests at 65,000A were performed with Class J, fast acting: please refer to the table below for maximum allowed ampere rating of the fuse. Use fuses only.

### Co-ordination type 1 (UL508)

Part No.	Prospective short circuit current [kArms]	Max. fuse size [A]	Class/ Model	Voltage [VAC]
RM1..25..	65	30	J or CC	600
RM1..50..	65	30	J	600
		20	HSJ20 (Mersen*)	600
RM1..75..	65	80	J	600
		60	HSJ60 (Mersen*)	600
RM1..100..	65	80	J	600
		60	HSJ60 (Mersen*)	600

### Co-ordination type 2 (IEC/EN60947-4-3)

Part No.	Prospective short circuit current [kArms]	Max. fuse size [A]	Brand	Model	Size
RM1.xx.25.. (xx = 23, 40 or 48)	10	25	Mersen*	6.9 gRB 10-25	10.3 x 38
RM1.60.25..	10	20	Mersen*	6.9 gRB 10-20	10.3 x 38
RM1.xx.50.. (xx = 23 or 40)	10	50	Mersen*	6.9zz CP gRC 14x51/50	14 x 51
RM1.xx.50.. (xx = 48 or 60)	10	50	Mersen*	6.9zz CP gRC 22x58/50	22 x 58
RM1.xx.75.. (xx = 23, 40, 48 or 60)	10	63	Mersen*	6.9zz CP gRC 22x58/63	22 x 58
RM1.xx.100.. (xx = 23, 40, 48 or 60)	10	100	Mersen*	6.9zz CP gRC 22x58/100	22 x 58

zz = 00, without fuse trip indication

zz = 21, with fuse trip indication

\* Formerly Ferraz Shawmut



## Type 2 Protection with Miniature Circuit Breakers (M.C.B.s)

Solid State Relay type	ABB Model no. for Z - type M. C. B. (rated current)	ABB Model no. for B - type M. C. B. (rated current)	Wire cross sectional area [mm <sup>2</sup> ]	Minimum length of Cu wire conductor [m]	
<b>RM1..25..</b>	<b>1-pole</b>				
	S201-Z4 (4A)	S201-B2 (2A)	1.0	21.0	
	S201-Z6 UC (6A)	S201-B2 (2A)	1.0	21.0	
			1.5	31.5	
<b>RM1..50..</b>	<b>1-pole</b>				
	S201-Z10 (10A)	S201-B4 (4A)	1.0	7.6	
			1.5	11.4	
			2.5	19.0	
	S201-Z16 (16A)	S201-B6 (6A)	1.0	5.2	
			1.5	7.8	
			2.5	13.0	
			4.0	20.8	
	S201-Z20 (20A)	S201-B10 (10A)	1.5	12.6	
			2.5	21.0	
	S201-Z25 (25A)	S201-B13 (13A)	2.5	25.0	
			4.0	40.0	
	<b>2-pole</b>	S202-Z25 (25A)	S202-B13 (13A)	2.5	19.0
4.0				30.4	
<b>RM1..75..</b>	<b>1-pole</b>				
	S201-Z20 (20A)	S201-B10 (10A)	1.5	4.2	
			2.5	7.0	
			4.0	11.2	
	S201-Z32 (32A)	S201-B16 (16A)	2.5	13.0	
			4.0	20.8	
			6.0	31.2	
	<b>2-pole</b>	S202-Z20 (20A)	S202-B10 (10A)	1.5	1.8
				2.5	3.0
				4.0	4.8
	S202-Z32 (32A)	S202-B16 (16A)	2.5	5.0	
			4.0	8.0	
			6.0	12.0	
10.0			20.0		
S202-Z50 (50A)	S202-B25 (25A)	4.0	14.8		
		6.0	22.2		
		10.0	37.0		
<b>RM1..100..</b>	<b>1-pole</b>				
	S201-Z50 (50A)	S201-B25 (25A)	4.0	4.8	
			6.0	7.2	
			10.0	12.0	
			16.0	19.2	
	S201-Z63 (63A)	S201-B32 (32A)	6.0	7.2	
			10.0	12.0	
16.0			19.2		

\* Between MCB and Load (including return path which goes back to the mains).

Note: A prospective current of 6kA and a 230/400V power supply system is assumed for the above suggested specifications. For cables with different cross section than those mentioned above please consult Carlo Gavazzi's Technical Support Group.

## Environmental Information

The declaration in this section is prepared in compliance with People's Republic of China Electronic Industry Standard SJ/T11364-2014: Marking for the Restricted Use of Hazardous Substances in Electronic and Electrical Products.

Part Name	Toxic or Harardous Substances and Elements					
	Lead (Pb)	Mercury (Hg)	Cadmium (Cd)	Hexavalent Chromium (Cr(VI))	Polybrominated biphenyls (PBB)	Polybrominated diphenyl ethers (PBDE)
Power Unit Assembly	x	○	○	○	○	○
<p>○: Indicates that said hazardous substance contained in homogeneous materials for this part are below the limit requirement of GB/T 26572.</p> <p>X: Indicates that said hazardous substance contained in one of the homogeneous materials used for this part is above the limit requirement of GB/T 26572.</p>						

## 环境特性

这份申明根据中华人民共和国电子工业标准  
SJ/T11364-2014：标注在电子电气产品中限定使用的有害物质

零件名称	有毒或有害物质与元素					
	铅 (Pb)	汞 (Hg)	镉 (Cd)	六价铬 (Cr(VI))	多溴化联苯 (PBB)	多溴联苯醚 (PBDE)
功率单元	x	○	○	○	○	○
<p>○:此零件所有材料中含有的该有害物质低于GB/T 26572的限定。</p> <p>X: 此零件某种材料中含有的该有害物质高于GB/T 26572的限定。</p>						





## FASTON terminals



- Faston tabs
- Tab dimensions according to DIN 46342 part 1
- Pure tin-plated brass

### Ordering Key

#### Screw mounted Faston terminals

**RM1A48D25** | **F 4**\*

RS, RM Solid State Relay \_\_\_\_\_  
 Faston terminals \_\_\_\_\_  
 Tab orientation \_\_\_\_\_  
 Input Tab width: 4.8mm  
 Output Tab width: 6.3mm

#### Faston terminals in packs of 20

**RM48**\*\* | **F4**\*

RS, RM Solid State Relay \_\_\_\_\_  
 Tab orientation \_\_\_\_\_

\* 0: Flat (0°)  
 4: Angled (45°)

\*\* 48: 4.8mm faston for input  
 63: 6.3mm faston for output

## Fork Terminals

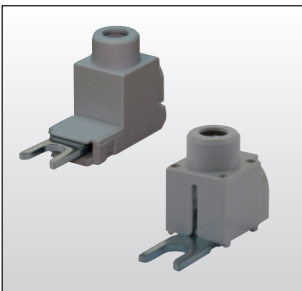

- Terminal adaptors for 35mm<sup>2</sup> cable
- Type RM635FK
- Pack size: 10 pieces

### Ordering Key

**RM635FK** | **P**

RM terminal adaptor \_\_\_\_\_  
 Touch protected (optional) \_\_\_\_\_

## Other Accessories



- Graphite thermal pad with adhesive on one side
- Type KK071CUT
- Dimensions: 35 x 43 x 0.25mm
- Packing quantity: 50pcs.

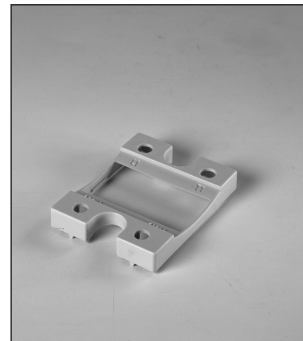

- Touch safety cover
- Type RMIP20
- IP20 protection degree
- Pack size: 20 pieces

All accessories can be ordered pre-assembled with Solid State Relays.  
 Other accessories include DIN rail adaptors, fuses, varistors and spacers.

For further information refer to Accessories datasheets at:  
[www.productselection.net/PDF/UK/SSR\\_Accessories.pdf](http://www.productselection.net/PDF/UK/SSR_Accessories.pdf)