

CLASSE 100 A12C Audio handset

344262

Description

2 WIRE audio handset for wall mounted or table-top installation (with specific support to be purchased separately). Keys available: door lock release, entrance panel/scrolling activation and staircase lights control.

LEDs used for: call exclusion, door status, connection with the entrance panel. Bell volume adjustment (with call exclusion) using the appropriate selector. 16 different ringtones available.

For wall mounted installation, the bracket supplied must be used.

The device must be configured.

Related Items

344552 Support for table top installation

Technical data

Power supply from SCS BUS:	18 – 27 Vdc
Stand by absorption:	5 mA
Max. operating absorption:	35 mA
Operating temperature:	5 – 45 °C

Dimensional data

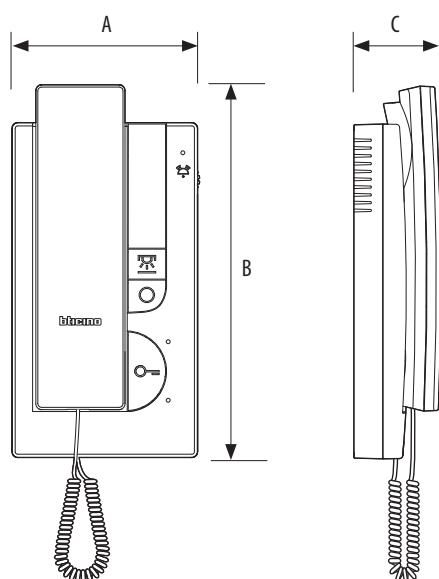

A	B	C
95 mm	192 mm	45 mm

Front view

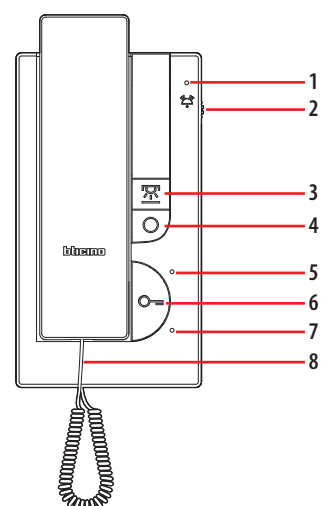

Rear view

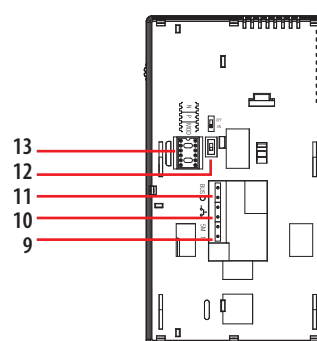

Legend

1. Call exclusion notification red LED
2. Bell volume adjustment and exclusion
3. Staircase light control key
4. Entrance panel/scrolling activation key
5. Door lock activation and/or door status red LED
6. Door lock control key
7. Connection status green LED
ON flashing = call active
ON steady = conversation active
8. Cord that can be extended and connected with RJ connectors.
9. Clamps (1 - 5M) for the connection of the additional bell
The connection must be point - point on the clamps of the additional bells.
10. Clamps (-) for the connection of an external call to the floor pushbutton
11. 2 WIRE SCS/BUS connection clamps
12. Line termination ON/OFF micro-switch
13. Configurator socket

Configuration

The device must be only physically configured.

N - handset number

The configurators connected to the N sockets of the device assign an identification number within the system to each handset. The handsets must be configured in progressive order. The handsets must be configured in progressive order. Handsets with parallel connection (max 3 are allowed inside apartments without item 346850) must be configured using the same N configurator. In parallel with the main handset, additional handsets and/or bells may be installed.

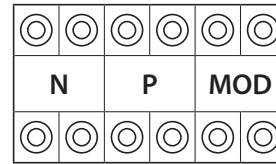

P – entrance panel association

The configurators connected to the P sockets of the device identify the associated EP, which is the first entrance panel that switches itself on when the pushbutton is pressed the first time, as well as which door lock is activated when pressing the door lock pushbutton while the handset is idle.

MOD – operating mode

The configurators connected to the MOD sockets of the device assign the operating mode to the device keys based on the following indications.

MODE	KEY	FUNCTION
M = 00		Direct EP door lock activation (EP configured with the same P), or activation of the EP upon connection
		Activation of the EP (configured with the same P) directly without call. Cycling of EP and cameras installed in the system. Direct call to the switchboard, if present in the system and appropriately configured.
		Actuator activation for staircase light pushbutton
M = 01		Direct EP door lock activation (EP configured with the same P), or activation of the EP upon connection
		Activation of the EP (configured with the same P) directly without call. Cycling of EP and cameras installed in the system. Direct call to the switchboard, if present in the system and appropriately configured.
		EP door lock release (configured with P+1), directly without call, or activation of the actuator 346210 - 346200 (configured with P+1 and MOD=5), or activation of door lock actuators 346230 - 346260 (configured with P + 1)
M = 02		Direct EP door lock activation (EP configured with the same P), or activation of the EP upon connection
		Internal intercom. It sends the call to all the handsets with the same address
		Actuator activation for staircase light pushbutton
M = 03		Direct EP door lock activation (EP configured with the same P), or activation of the EP upon connection
		Activation of the EP (configured with the same P) directly without call. Cycling of EP and cameras installed in the system. Direct call to the switchboard, if present in the system and appropriately configured.
		Internal intercom. It sends the call to all the handsets with the same address
M = 04		Direct EP door lock activation (EP configured with the same P), or activation of the EP upon connection
		Intercom to all the handsets configured with N=1
		Actuator activation for staircase light pushbutton

Bell selection

The handset offers the **possibility to select among 16 types of bells** with programmed ringtones, which can be freely associated to the following type of calls:

- Call from the entrance panel (configured with S=0)
- Intercom call
- Floor call

Bell selection from the MAIN ENTRANCE PANEL (S=0)

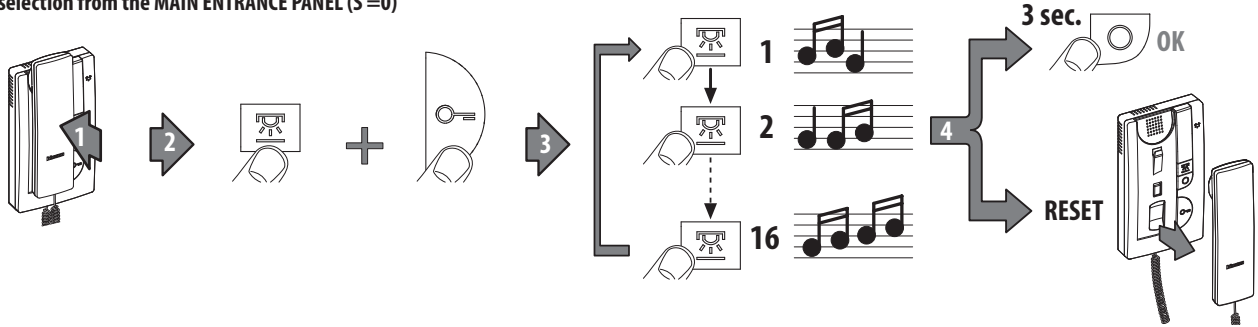

FLOOR CALL bell selection

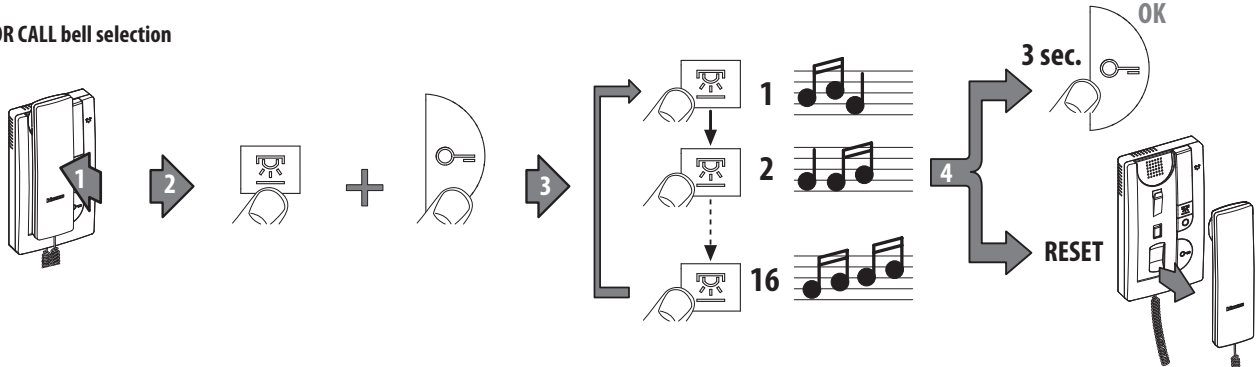

INTERCOM CALL bell selection

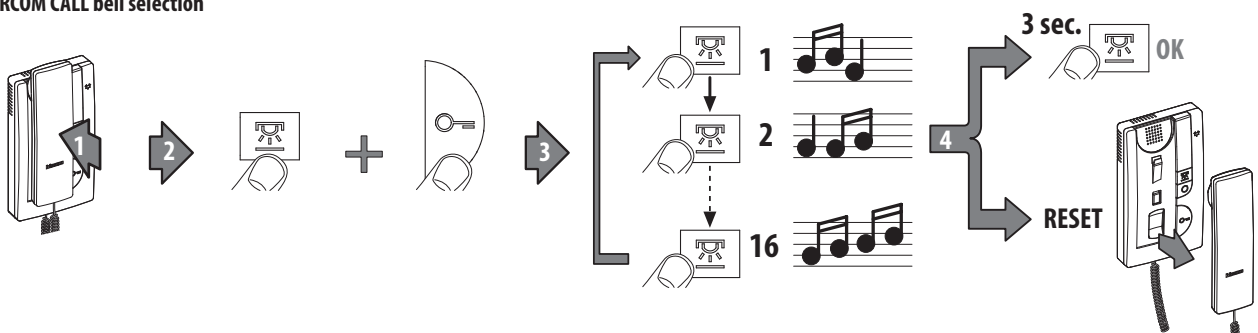

LED notifications

