



## AANDACHTSPUNTEN:

### *Psmighting is 100% Belgisch!*

Alle opgegeven wattages, vermeld bij de verlichtingsarmaturen, zijn de maximum waarden en dienen eventueel aangepast te worden naar een lager wattage naargelang de plaats waar het toestel wordt geïnstalleerd!

Alle verlichtingsarmaturen dienen geplaatst en aangesloten te worden door een erkend elektricien die de nodige kennis en ervaring heeft, alsook vergunning voor het plaatsen van onze armaturen. Dit dient ook altijd te gebeuren volgens de geldende reglementering en officiële instructies. De installateur is ervoor verantwoordelijk dat de gebruikte voorschakelapparatuur voldoet aan de geldende CE-norm!

De afmetingen van de verlichtingsarmaturen kunnen te allen tijde worden aangepast indien wij dit nodig achten. Hiervoor kan dus geen schadevergoeding worden geëist. De aangegeven hoogtes zijn niet bindend, deze zijn variabel naargelang het gekozen lamptype.

De opgegeven prijzen kunnen te allen tijde aangepast worden en dit ten gevolge van schommelingen in grondstof prijzen. Prijsstijgingen zullen 3 maanden vooraf op onze website [www.psmighting.be](http://www.psmighting.be) worden aangekondigd. Prijzen die per abuis foutief in deze catalogoog staan worden ook op onze website in een errata vermeld.

### **Belangrijk bij ontvangst goederen:**

Nazicht van de verpakking  
Nazicht van het aantal ontvangen colli's (vooraleer wordt ondertekend voor ontvangst)

## POINTS PRIORITAIRES:

### *Psmighting est 100% belge!*

Toutes puissances en Watts, mentionnées dans le catalogue, sont les valeurs les maximum et doivent être adaptées selon la place d'installation de l'armature.

Le placement, le raccordement et l'essai des armatures doivent toujours être effectués par un installateur électricien agréé, qui a la connaissance et l'expérience, suivant le règlement sur les installations électriques en vigueur. L'installateur est responsable de l'utilisation des ballasts, transfos, conformes aux normes CE et EMC.

Les dimensions des armatures peuvent être changées à tout moment quand nous le trouvons nécessaire. Il est donc hors question de demander d'indemnité.

Les hauteurs mentionnées dans le catalogue ne sont pas contraignantes, celles-ci sont variables selon le type de lampe choisi.

Les prix mentionnés peuvent être changés à tout moment à cause des variations de prix des matières premières. Les hausses de prix seront annoncées sur notre site web 3 mois en avance.

Des prix qui sont mis faux accidentellement dans le catalogue seront mis dans un errata sur le site web.

### **Important en cas de réception de marchandises:**

Vérification de l'emballage  
Vérification du nombre de colis (avant de signer pour réception des marchandises)

## POINTS THAT REQUIRE SPECIAL ATTENTION:

### *Psmighting is 100% Belgian!*

All wattages mentioned in the catalogue are maximum values and are to be changed to lower wattages according to the place where the lighting fixture is installed.

All lighting fixtures need to be installed and connected by an acknowledged electrician, who has the necessary knowledge and experience, including a license to install our lighting fixtures. This has to be done according to the valid CE and EMC regulations. The used ballasts have to meet these regulations as well.

The dimensions of the lighting fixtures can be changed at any time without prior notice if we think it is necessary. It is out of the question to get a compensation afterwards. Heights mentioned in this catalogue are not binding. These can vary according to the chosen lamp type.

The prices in the pricelist can change at any time and this due to price fluctuations of the raw materials. Price increase will be announced on our website 3 months in advance. False prices that are accidentally put in the pricelist will be mentioned correctly on the website in an errata

### **Important in case of reception of the goods:**

Check-up of the packaging  
Check-up of the number of parcels (before signing for receipt)

## SCHWERPUNKTE:

### *Psmighting ist 100% belgisch!*

Alle Wattleistungen bei der Leuchten sind Höchstwerte. Diese sollen zu einer geringeren Wattleistung je nach dem Platz der Leuchte angepasst werden.

Alle Leuchten müssen von einem autorisierten Elektro-Fachmann montiert und angeschlossen werden, der die übliche Kenntnisse und Erfahrung hat, sowie eine vorherige Genehmigung um unsere Leuchten zu montieren. Der Installateur ist dafür verantwortlich, dass das verwendete Vorschaltgerät der geltenden CE-Norm entspricht, einschließlich der elektromagnetischen Kompatibilität.











Die Abmessungen der Leuchten können jederzeit angepasst werden, wenn wir das für notwendig halten. Es ist unmöglich dafür Schadenersatz zu bekommen. Die angedeutete Höhen sind nicht bindend. Diese sind variabel je nach dem gewählten Lampentyp.

Die erwähnten Preise können jederzeit angepasst werden auf Grund der Preisschwankungen der Rohstoffe. Preiserhöhungen werden immer 3 Monate im voraus auf unserer Website gemeldet. Falsche Preise im Katalog werden auch in einer Korrekturliste auf der Website veröffentlicht.





### **Wichtig beim Empfang der Güter:**

Überprüfung der Verpackung  
Überprüfung der Anzahl der Frachtstücke (bevor Unterzeichnung für Empfang)

## Indoor

Downlights	P. 1 - 103	
Accessories	P. 104 - 123	
Spots & pendants	P. 124 - 163	
Bases	P. 164 - 215	
Architectural lighting	P. 216 - 297	
Table & floorlamps	P. 298 - 309	
Wall Lights	P. 310 - 363	
LED	P. 364 - 433	
Profiles	P. 434 - 486	
Floorlights	P. 487 - 506	

## Outdoor

Downlights	P. 507 - 513	
In-ground luminaires	P. 514 - 567	
Inox Stainless steel 316	P. 568 - 612	
Aluminium	P. 613 - 676	



# INDOOR | Downlights

## ACCESSORIES

003.RAL/.. P.4



## Ø29-30

ST33/..-ST43/..P.10



## Ø38

ZIA35P/.. P.12



## Ø48-49

ZIA35/.. P.11



## Ø50

W3083/.. P.374



## Ø65-70

301V/.. P.20-21



## Ø70

DISCO/.. P.28



## Ø80 UNIVERSAL SYSTEM

PICO50/.. P.32



## PLASTERKIT

S6/.. P.5

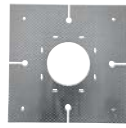

## Ø39

ZIA35M/.. P.13



## Ø60

ARCA35/.. P.19



## Ø70 SYSTEM

SINGLE70/.. P.30



AQUANODOTIP44/..P.34



S10.198/.. P.7

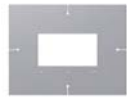

ZIAMINILED/..P.15



## Ø63

ZIA50/.. P.14



## Ø65

PICO35/.. P.23



CAMBIO/.. P.38



## TRANSFOKAST

TR30/.. P.9



## Ø39-40

D43/.. P.11



## Ø49

FOCUS35/.. P.19



## Ø65 SYSTEM

SINGLE65/.. P.26



## Ø72-75

ARCA50/.. P.19



## Ø80 KOZA

1474/./.. P.50-51



## ADAPTION RING

120.80/.. P.69



33M/.. P.16-17



ZIA50V/.. P.14



## Ø64

FOCUS50/.. P.19



CASDIVA35/.. P.27



## Ø75-76

ROUNDBASEUSA/.. P.55



1479/./.. P.51-52





ø65 SYSTEM	26, 27, 28
ø70 SYSTEM	30, 31, 32
ø80 SYSTEM	46, 47, 48
101H/..	95
102H/..	40
201/..	95
202/.. 202.B/..	40
301V/.. 301V.230V/..	20, 21
33M/.. 43M/..	16
ADAPTION RING	69 - 74
AQUAGR/..	41
AQUANODOTIP44/..	34
ARCA35/.. ARCA50/..	19
ARIA/..	38
BORA50/..	44
CAMBIO/..	38
CANO35/.. CANO50/..	25, 34
COCO50/.. COCO.ES50/..	43, 44
CONVERTIBLE SYSTEM	54 - 68
CROSS50/..	95
CUSCO/..	41
D33/.. D43/..	5, 10, 11
DECO50/..	49
DISCO/.. DISCO.ES50/..	28, 29
DIVA35/.. DIVA50/..	24, 33
DIVA50/..LN DIVA50.ES50/..LN PUNCHED	36, 37
DIVA AR70/..	41
FABO/..	39
FOCUS35/.. FOCUS50/..	19
FOX/..	45, 46
GALA/..	44
HERO50/.. HERO.ES50/..	49
KOX	58
KOZA	50, 51, 52
KUBO50/.. KUBO.ES50/.. KUBOGLAS50/..	42, 43
ONO/..	29
PICO20/.. PICO35/.. PICO35DOWN/..	22, 23
PICO50/..	32
PICO50.ES50/..LN PICO50/..LN PUNCHED ø80	36, 37
PICO AR70/..	41
PICODOWN50/..	33
PLASTERKIT	5, 6, 7
QUAD/..	44
RAL COLOUR	4
RIO35/..	13
ROUNDBASE/..	55
SCOOP/.. SCOOPC/.. SCOOPNODOT/..	94, 95
SCS SYSTEM ( SQUARE CLICK SYSTEM)	74 - 94
SENSA/..	39
SINGLE65/..	26
SINGLE70/..	30
SINGLEBASE/..	56
SIRA35CH/.. SIRA35M/..	23, 24

SIRA50CH/.. SIRA50M/..	35
ST33/.. ST43/.. ST50X50/..	10
TOLEDO	96 - 103
TRANSFOKAST TR20/..	8, 9
TRIPLEBASE/..	58
TWIN65/..	26
TWIN70/..	30
TWINBASE/..	57
TWOBASE/..	57
VARIO2X35/..	22
VARIO35/..	22
VARIO50/.. VARIO.E550/..	48
VIDRIO50/.. VIDRIO/..	34, 40
VIDRIOGLASS/..	34
YOKO/.. - YOKO.E550/..	29

**Ø80**



**Ø80 SYSTEM**

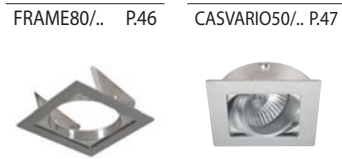

**Ø80**



**Ø80 CONVERTIBLE SYSTEM**

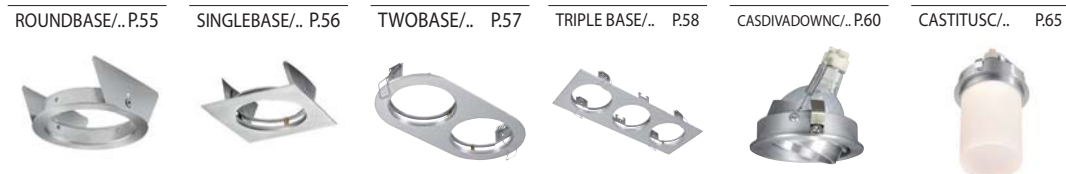

**Ø84 TOLEDO**

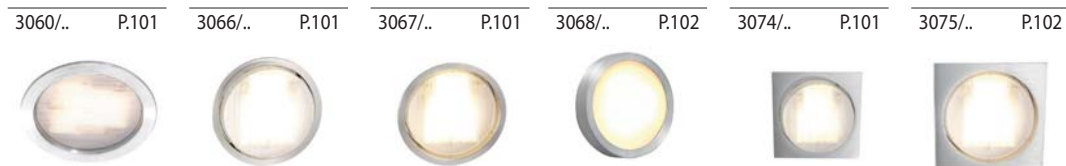

**SQUARE CLICK SYSTEM**

**BASES**



ZENO35/..	25
ZENO35B3/..	25
ZENO50/..	35
ZENO50B3/..	35
ZIA35/..	11
ZIA35C/..	13
ZIA35CG/..	14
ZIA35M/..	13
ZIA35P/..	12
ZIA35V/..	12
ZIA35VT/..	12
ZIA50/..	14
ZIA50GR/..	14
ZIA50V/..	14
ZIALED/..	15
ZIALED.230V/..	15
ZIAMINI.C.LED/..	16
ZIAMINILED/..	15
ZOOM	45

003.RAL/.. - RAL COLOUR

IP20  0.1200  

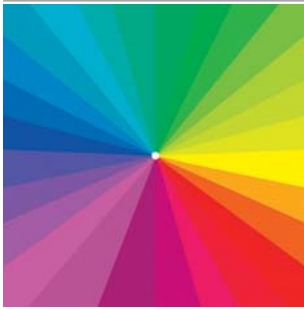

supplement - fixed price RAL colour NET PRICE!  
 Supplement - Preis für RAL Farbe gilt als NETTOPREIS!

Ref cat (XX)  
 003.RAL

S1/.. - TORSION SPRINGS

IP20  0.0050  



supplement - set torsion springs  
 Supplement - Set Torsionfedern

Ref cat (01)  
 S1

S2/.. - FLAT SPRINGS

IP20  0.0090  



supplement - set flat springs  
 Supplement - Set Blattfedern

Ref cat (01)  
 S2

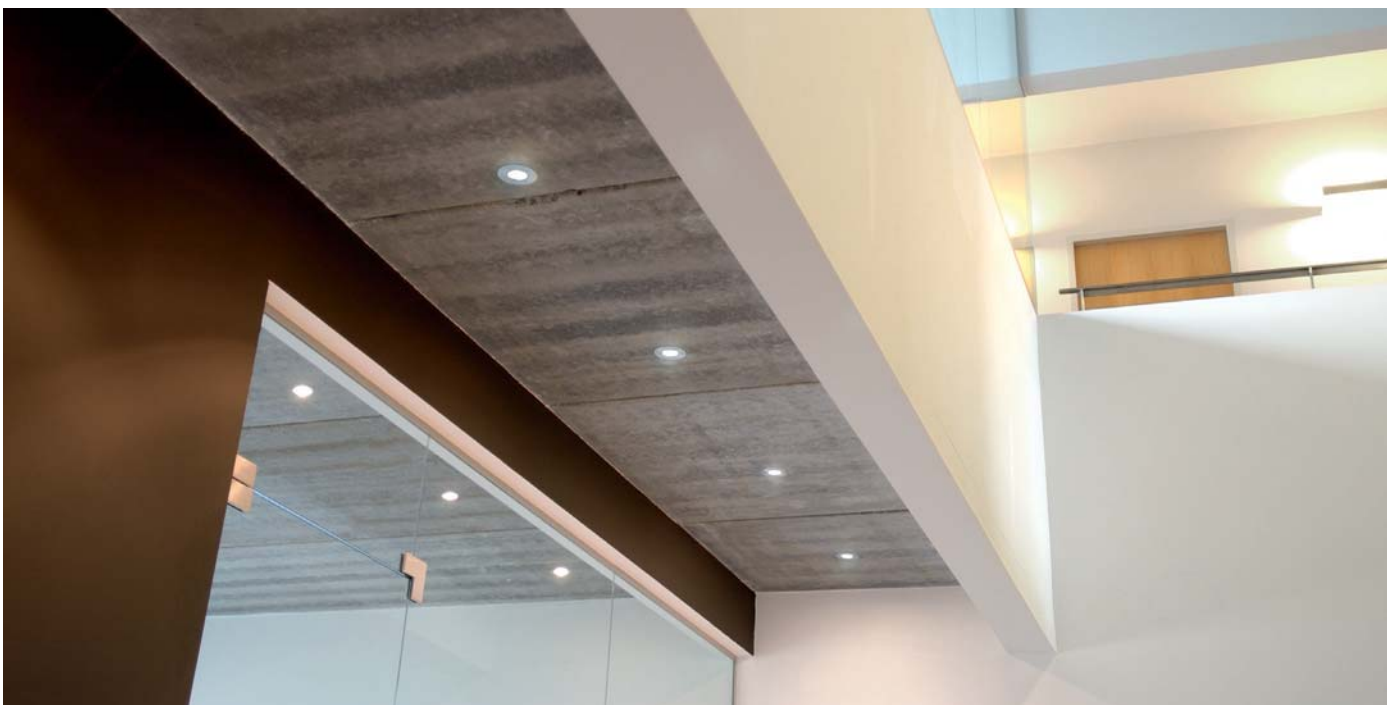



**PLASTERKIT**

**PLAASTERKIT | KIT A EMPLÂTRER | EINPUTZRAHMEN**

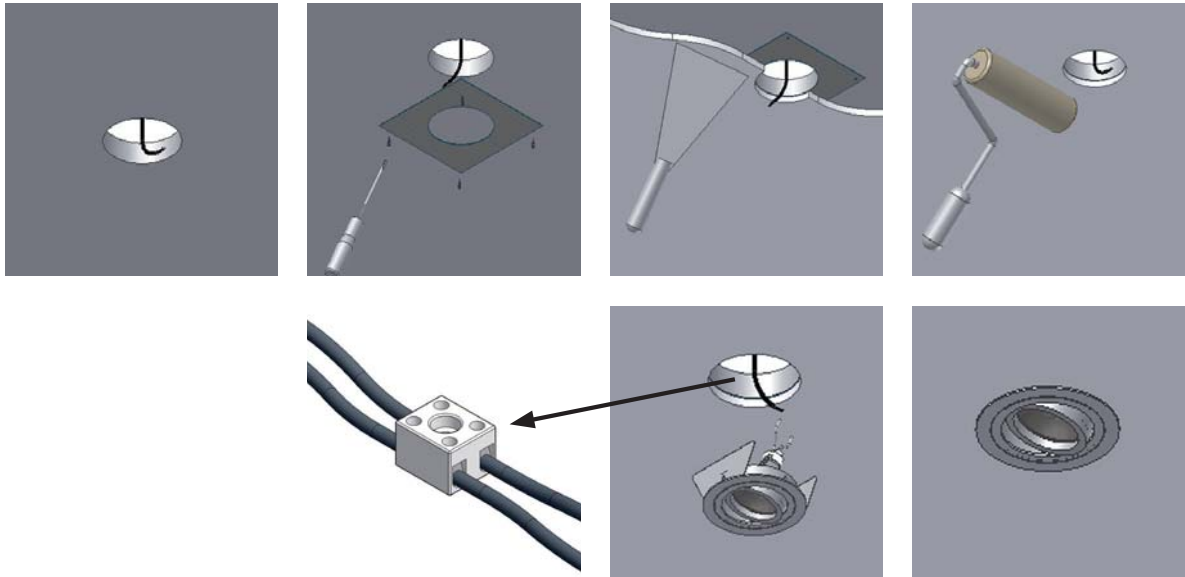

Enkel spots met bladveren S2 | Seulement spots avec ressorts à lammelles S2 | Only for spots with flat springs S2 | Nur für Spot mit Blattfedern S2  
 Wachten tot het stukwerk volledig uitgedroogd is vooraleer de spots te monteren!  
 Attendre jusqu' a ce que le plâtre s'est complètement asséché avant d'installer les spots!  
 Wait until plaster is completely dried out before installing the downlights!  
 Warten bis das Stückmörtel vollständig trocken ist, bevor die Einbaustrahler zu installieren.

**S6/.. - PLASTERKIT**

IP20

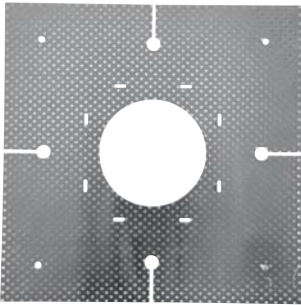

plasterkit  
Einputzrahmen

Ø20	Ø25	Ø30	Ø35	Ø40
S6.20	S6.25	S6.30	S6.35	S6.40
Options/Optionen	Options/Optionen	Options/Optionen	Options/Optionen	Options/Optionen
		33M D33/.. ST33/.. ST43/.. ST50X50/.. ZIAMINILED - ZIAMI- NICLED		3088/.. ORKA 43M D43/.. ZIA35C/.. ZIA35CG/.. ZIA35M/.. ZIA35P/.. ZIA35VT/..

**S6/.. - PLASTERKIT**

IP20

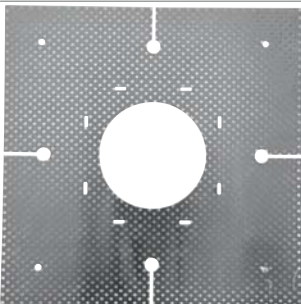

plasterkit  
Einputzrahmen

Ø45	Ø50	Ø55	Ø60
S6.45	S6.50	S6.55	S6.60
Options/Optionen	Options/Optionen	Options/Optionen	Options/Optionen
	FOCUS35/.. RIO35/.. ZIA35/.. ZIA35V/.. ZIA50V/.. ZIALED - ZIALED 230V		ARCA35/.. CESAR

S6/.. - PLASTERKIT

IP20   

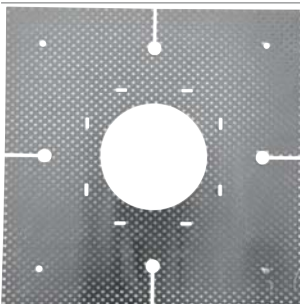

plasterkit  
Einputzrahmen

Ø65 S6.65	Ø70 S6.70	Ø75 S6.75	Ø80 S6.80
Options/Optionen	Options/Optionen	Options/Optionen	Options/Optionen
1810/.. 301V - 302V - 303V DIVA35 - PICO35 - CANO35 - ZENO35 - SIRA35 FOCUS50/.. SINGLE65/.. VARIO35/.. ZIA50 + ZIA50GR	DISCO - YOKO - ONO SINGLE70/..	ARCA50/.. OSCAR 1345 - 1346	102H/.. 202 - 202B ARIA - CAMBIO - VIDRIO FRAME80/.. KOZA KUBO - COCO - GALA PICO - DIVA LN PUNCHED PICO50 - DIVA50 - SIRA50 - CANO50 - ZENO50 VARIO - HERO - DECO

S6/.. - PLASTERKIT

IP20   

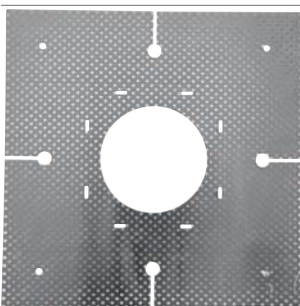

plasterkit  
Einputzrahmen

Ø100 S6.100	Ø87 S6.87	Ø90 S6.90	Ø95 S6.95
Options/Optionen	Options/Optionen	Options/Optionen	Options/Optionen
AQUAGR/.. OLIVIA DICRO 1840	FRAME1B/.. TOLEDO Ø84	FRAME1A/.. QUAD/..	

S7/.. - PLASTERKIT

IP20   

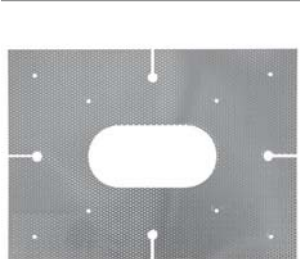

plasterkit  
Einputzrahmen

2xØ70 S7.70	2xØ80 S7.80	2xØ90 S7.90	Ø132 S7.65	Ø140 S7.65V	Ø2X87 S7.87
Options/Optionen	Options/Optionen	Options/Optionen	Options/Optionen	Options/Optionen	Options/Optionen
S12/.. TWIN70/..	S12/.. TWINBASE/..	FRAME2A/.. S12/..	S12/.. TWIN65/..	S12/.. VARIO2X35/..	FRAME2B/.. S12/..

S8/.. - PLASTERKIT

IP20   

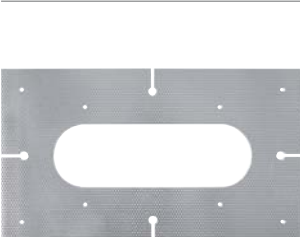

plasterkit  
Einputzrahmen

3xØ80 S8.80	3xØ87 S8.87	3xØ90 S8.90
Options/Optionen	Options/Optionen	Options/Optionen
S13/.. TRIPLEBASE/..	FRAME3B/.. S13/..	FRAME3A/.. S13/..

S9/.. - PLASTERKIT

IP20   

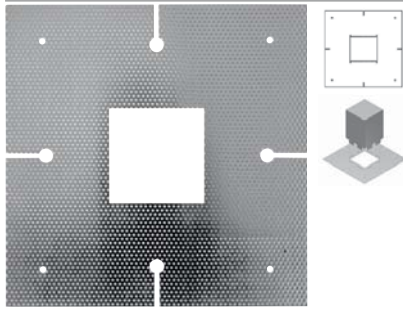

plasterkit  
Einputzrahmen

108x108	70x70	92x92
S9.108	S9.70	S9.92
Options/Optionen	Options/Optionen	Options/Optionen
CAMERA 945 S14/..	FOX DIR - FIX S11/.. S14/..	CROSS50/.. S11/.. S14/..

S10.198/.. - PLASTERKIT

IP20   

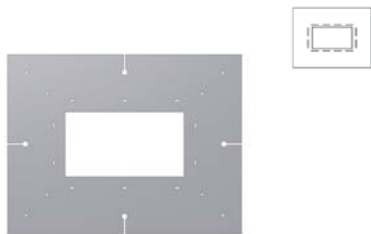

plasterkit  
Einputzrahmen

Ref cat (01)

S10.198

Dimensions

 L390xB300

 198x108

Options

946/.. - CAMERA IN

S15/.. - BOX

S11/.. - BOX

IP20    0,1680 

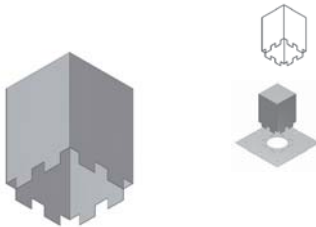

build-in box - to combine with S9.70 - S9.92 and S6.--  
Einbaudose - zu kombinieren mit S9.70 - S9.92 und S6.--

Ref cat (01)

S11

Dimensions

 L100xB100xH135

S12/.. - BOX

IP20   

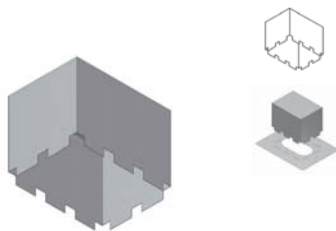

build-in box - to combine with S7.65 - S7.65V - S7.70 - S7.80  
- S7.87 - S7.90

Einbaudose - zu kombinieren mit S7.65 - S7.65V - S7.70 -  
S7.80 - S7.87 - S7.90

Ref cat (01)

S12

Dimensions

 L185xB100xH135

S13/.. - BOX

IP20   

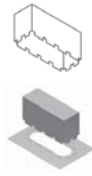
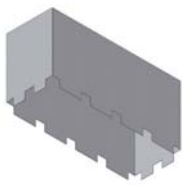

build-in box - to combine with S8.80 - S8.87 - S8.90  
Einbaudose - zu kombinieren mit S8.80 - S8.87 - S8.90

Ref cat (01)

S13

Dimensions

↔ L280xB100xH135

S14/.. - BOX

IP20   



build-in box - to combine with S9.70 - S9.92 - S9.108  
Einbaudose - zu kombinieren mit S9.70 - S9.92 - S9.108

Ref cat (01)

S14

Dimensions

↔ L130xB130xH135

S15/.. - BOX

IP20   

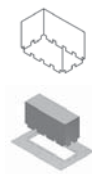
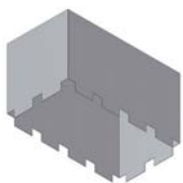

build-in box - to combine with S10.198  
Einbaudose - zu kombinieren mit S10.198

Ref cat (01)

S15

Dimensions

↔ L240xB130xH135

TR20/.. - TRANSFOKAST

IP20    



multiple transformer box - empty  
mehnteiliges Trafogehäuse - leer

Ref cat (01)

TR20

Dimensions

↔ B200xH300xD200

**TR30/.. - TRANSFOKAST**

IP20    5,8500 



multiple transformer box - empty  
mehnteiliges Trafogehäuse - leer

Ref cat (01)

TR30

**Dimensions**

↔ B300xH400xD200

**TR40/.. - TRANSFOKAST**

IP20    10,3900 



multiple transformer box - empty  
mehnteiliges Trafogehäuse - leer

Ref cat (01)

TR40

**Dimensions**

↔ B600xH400xD200

**TR60/.. - TRANSFOKAST**

IP20    14,4600 



multiple transformer box - empty  
mehnteiliges Trafogehäuse - leer

Ref cat (01)

TR60

**Dimensions**

↔ B600xH600xD200

**TR80/.. - TRANSFOKAST**

IP20    18,8000 



multiple transformer box - empty  
mehnteiliges Trafogehäuse - leer

Ref cat (01)

TR80

**Dimensions**

↔ B600xH800xD200

# INDOOR | Downlights | STARLIGHT | STARLIGHT Ø30 | DOWNLIGHT D33

Adjust the wattage to the type of ceiling (concrete, wood, PVC, etc). Wood , PVC > max.5-10W / Concrete > max.5-20W

Wattleistung auf den Typ der Decke abstimmen (Beton, Holz, PVC, usw). Holz , PVC > max.5-10W / Beton > max.5-20W

## ST33/.. - STARLIGHT

~12V S1 IP20 0,0324 0,5 m 05.10.02



downlight for veranda profiles - round - without transformer  
Einbaustrahler für Verandaprofilen - rund - ohne Trafo

### Lamptype

QT9-ax G4 (1) 20W 12V

### Dimensions

Ø33xH30

Ø30 50

### Options

S6.30/.. - PLASTERKIT

### Ref cat (CAS)

ST33.0  
ST33.1  
ST33.1M  
ST33.2  
ST33.4  
ST33.7  
ST33.11  
ST33.13  
ST33.14  
ST33.16  
ST33.18

build-in

## ST43/.. - STARLIGHT Ø30

~12V S1 IP20 0,0350 0,5 m 05.10.02



downlight for veranda profiles - round - without transformer  
Einbaustrahler für Verandaprofilen - rund - ohne Trafo

### Lamptype

QT9-ax G4 (1) 20W 12V

### Dimensions

Ø43xH30

Ø30 50

### Options

S6.30/.. - PLASTERKIT

### Ref cat (CAS)

ST43.0  
ST43.1  
ST43.1M  
ST43.2  
ST43.4  
ST43.7  
ST43.11  
ST43.13  
ST43.14  
ST43.16  
ST43.18

build-in

## ST50X50/.. - STARLIGHT Ø30

~12V S1 IP20 0,0422 0,5 m 05.10.02



downlight for veranda profiles - square - without transformer  
Einbaustrahler für Verandaprofilen - viereckig - ohne Trafo

### Lamptype

QT9-ax G4 (1) 20W 12V

### Dimensions

L50xB50xH30

Ø30 50

### Options

S6.30/.. - PLASTERKIT

### Ref cat (CAS)

ST50X50.0  
ST50X50.1  
ST50X50.1M  
ST50X50.2  
ST50X50.4  
ST50X50.7  
ST50X50.11  
ST50X50.13  
ST50X50.14  
ST50X50.16  
ST50X50.18

build-in

## D33/.. - DOWNLIGHT D33

~12V S1 IP20 0,0483 0,5 m 05.10.02



downlight for veranda profiles - round - without transformer  
Einbaustrahler für Verandaprofilen - rund - ohne Trafo

### Lamptype

QT9-ax G4 (1) 20W 12V

### Dimensions

Ø33xH45

Ø30 65

### Options

S6.30/.. - PLASTERKIT

### Ref cat (CAS)

D33.0  
D33.1  
D33.1M  
D33.1W  
D33.2  
D33.4  
D33.7  
D33.11  
D33.13  
D33.14  
D33.16  
D33.18

build-in

D43/.. - DOWNLIGHT Ø39-40

~12V S1 IP20 0,0717 0,5 m 05.10.02



downlight for veranda profiles - round - without transformer  
Einbaustrahler für Verandaprofilen - rund - ohne Trafo

**Lamptype**

QT9-ax G4 (1) 20W 12V

**Dimensions**

Ø43xH50

Ø39-40 70

**Options**

S6.40/.. - PLASTERKIT

**Ref cat (CAS)**

- D43.0
- D43.1
- D43.1M
- D43.1W
- D43.2
- D43.4
- D43.7
- D43.11
- D43.13
- D43.14
- D43.16
- D43.18

build-in



ZIA35/.. - Ø48-49

~12V S2 IP20 0,0564 0,5 m 05.10.02



downlight for veranda profiles - round - twin wall - without transformer  
Einbaustrahler für Verandaprofilen - rund - doppelwandig - ohne Trafo

**Lamptype**

QR-CB 35 GU4/GZ4 (1) 35W 12V

**Dimensions**

Ø58xH43

Ø48 63

**Options**

S6.50/.. - PLASTERKIT

**Ref cat (CAS)**

- ZIA35.0
- ZIA35.1
- ZIA35.1M
- ZIA35.2
- ZIA35.4
- ZIA35.7
- ZIA35.11
- ZIA35.13
- ZIA35.14
- ZIA35.16
- ZIA35.18

build-in

ZIA35V/.. - Ø48

~12V S2 IP20 0,0518 0,5 m 05.10.02



downlight for veranda profiles - round - twin wall - without transformer  
Einbaustrahler für Verandaprofilen - rund - doppelwandig - ohne Trafo

**Lamp type**

QR-CB 35 GU4/GZ4 (1) 35W 12V

**Dimensions**

Ø52xH43

Ø48 63

**Options**

S6.50/.. - PLASTERKIT

**Ref cat (CAS)**

- ZIA35V.0
- ZIA35V.1
- ZIA35V.1M
- ZIA35V.2
- ZIA35V.4
- ZIA35V.7
- ZIA35V.11
- ZIA35V.13
- ZIA35V.14
- ZIA35V.16
- ZIA35V.18

build-in

ZIA35VT/.. - Ø39-40

~12V S1 IP20 0,0291 0,5 m 05.10.02



downlight for veranda profiles - round - without transformer  
Einbaustrahler für Verandaprofilen - rund - ohne Trafo

**Lamp type**

QR-CB 35 GU4/GZ4 (1) 35W 12V

**Dimensions**

Ø52xH43

Ø39-40 63

**Options**

S6.40/.. - PLASTERKIT

**Ref cat (CAS)**

- ZIA35VT.0
- ZIA35VT.1
- ZIA35VT.1M
- ZIA35VT.2
- ZIA35VT.4
- ZIA35VT.7
- ZIA35VT.11
- ZIA35VT.13
- ZIA35VT.14
- ZIA35VT.16
- ZIA35VT.18

build-in

ZIA35P/.. - Ø38-39

~12V S1 IP20 0,0431 0,5 m 05.10.02



downlight for veranda profiles - round - without transformer  
Einbaustrahler für Verandaprofilen - rund - ohne Trafo

**Lamp type**

QR-CB 35 GU4/GZ4 (1) 35W 12V

**Dimensions**

Ø41xH43

Ø38-39 63

**Options**

S6.40/.. - PLASTERKIT

**Ref cat (CAS)**

- ZIA35P.0
- ZIA35P.1
- ZIA35P.1M
- ZIA35P.2
- ZIA35P.4
- ZIA35P.5
- ZIA35P.5B
- ZIA35P.5BB
- ZIA35P.7
- ZIA35P.11
- ZIA35P.13
- ZIA35P.14
- ZIA35P.16
- ZIA35P.18

build-in



RIO35/.. - Ø48-49

~12V S1 IP20 0,1155 0,5 m 05.10.02



downlight for veranda profiles - round - directional - without transformer  
Einbaustrahler für Verandaprofilen - rund - schwenkbar - ohne Trafo

**Lamptype**

QR-CB 35 GU4/GZ4 (1) 35W 12V

**Dimensions**

Ø54xH62  
 Ø48-49 70

**Options**

S6.50/.. - PLASTERKIT

**Ref cat (CAS)**

- RIO35.0
- RIO35.1
- RIO35.1M
- RIO35.2
- RIO35.4
- RIO35.7
- RIO35.11
- RIO35.13
- RIO35.14
- RIO35.16
- RIO35.18

build-in

ZIA35M/.. - Ø39-40

~12V S1 IP20 0,0264 0,5 m 05.10.02



downlight for veranda profiles - round - without transformer  
Einbaustrahler für Verandaprofilen - rund - ohne Trafo

**Lamptype**

QR-CB 35 GU4/GZ4 (1) 35W 12V

**Dimensions**

Ø44,5xH43  
 Ø39-40 63

**Options**

S6.40/.. - PLASTERKIT

**Ref cat (CAS)**

- ZIA35M.0
- ZIA35M.1
- ZIA35M.1M
- ZIA35M.2
- ZIA35M.4
- ZIA35M.7
- ZIA35M.11
- ZIA35M.13
- ZIA35M.14
- ZIA35M.16
- ZIA35M.18

build-in

ZIA35C/.. - Ø38

~12V S1 IP20 0,0329 0,5 m 05.10.02



downlight for veranda profiles - square - without transformer  
Einbaustrahler für Verandaprofilen - viereckig - ohne Trafo

**Lamptype**

QR-CB 35 GU4/GZ4 (1) 35W 12V

**Dimensions**

L41,5xB41,5xH43  
 Ø38 63

**Options**

S6.40/.. - PLASTERKIT

**Ref cat (CAS)**

- ZIA35C.0
- ZIA35C.1
- ZIA35C.1M
- ZIA35C.2
- ZIA35C.4
- ZIA35C.5
- ZIA35C.5B
- ZIA35C.5BB
- ZIA35C.7
- ZIA35C.11
- ZIA35C.13
- ZIA35C.14
- ZIA35C.16
- ZIA35C.18

build-in

ZIA35CG/.. - Ø38

~12V S1 IP20 0,0482 0,5 m 05.10.02



downlight for veranda profiles - square - without transformer  
Einbaustrahler für Verandaprofilen - viereckig - ohne Trafo

**Lamptype**

QR-CB 35 GU4/GZ4 (1) 35W 12V

**Dimensions**

L54x854xH43

Ø38 63

**Options**

S6.40/.. - PLASTERKIT

**Ref cat (CAS)**

- ZIA35CG.0
- ZIA35CG.1
- ZIA35CG.1M
- ZIA35CG.2
- ZIA35CG.4
- ZIA35CG.7
- ZIA35CG.11
- ZIA35CG.13
- ZIA35CG.14
- ZIA35CG.16
- ZIA35CG.18

build-in

ZIA50/.. - Ø63

~12V S2 IP20 0,0550 0,5 m 05.10.02



downlight for veranda profiles - round - twin wall - without transformer  
Einbaustrahler für Verandaprofilen - rund - doppelwandig - ohne Trafo

**Lamptype**

QR-CB 51 GU5,3/GX5,3 (1) 50W 12V

**Dimensions**

Ø73xH55

Ø63 75

**Options**

S6.65/.. - PLASTERKIT

**Ref cat (CAS)**

- ZIA50.0
- ZIA50.1
- ZIA50.1M
- ZIA50.2
- ZIA50.4
- ZIA50.7
- ZIA50.11
- ZIA50.13
- ZIA50.14
- ZIA50.16
- ZIA50.18

build-in

ZIA50GR/.. - Ø63

~12V S2 IP20 0,0392 0,5 m 05.10.02



downlight for veranda profiles - round - twin wall - without transformer  
Einbaustrahler für Verandaprofilen - rund - doppelwandig - ohne Trafo

**Lamptype**

QR-CB 51 GU5,3/GX5,3 (1) 50W 12V

**Dimensions**

Ø83xH55

Ø63 75

**Options**

S6.65/.. - PLASTERKIT

**Ref cat (CAS)**

- ZIA50GR.1
- ZIA50GR.1M
- ZIA50GR.2
- ZIA50GR.11
- ZIA50GR.14
- ZIA50GR.18

build-in

ZIA50V/.. - Ø49

~12V S1 IP20 0,0503 0,5 m 05.10.02



downlight for veranda profiles - round - without transformer  
Einbaustrahler für Verandaprofilen - rund - ohne Trafo

**Lamptype**

QR-CB 51 GU5,3/GX5,3 (1) 50W 12V

**Dimensions**

Ø54,5xH55

Ø49 75

**Options**

S6.50/.. - PLASTERKIT

**Ref cat (CAS)**

- ZIA50V.0
- ZIA50V.0M
- ZIA50V.1
- ZIA50V.1M
- ZIA50V.2
- ZIA50V.4
- ZIA50V.7
- ZIA50V.11
- ZIA50V.13
- ZIA50V.14
- ZIA50V.16
- ZIA50V.18

build-in

LED colours: cold white (CW) warm white (WW) or blue (B) - other LED colours on request  
 LED Farben: kalt Weiß (CW) warm Weiß (WW) oder Blau (B) - andere LED Farben auf Anfrage

**ZIALED.230V/.. - Ø48**

~230V  S2 IP44    0,1050  0,5 m  05.10.02 



build-in ceiling and wall light  
 Decken- und Wandleuchte für Einbau

**Lamp type**

 3 led 230V . (1) 4,8VA 230V

**Dimensions**

 Ø58,5xH64

 Ø48  74

**Options**

S6.50/.. - PLASTERKIT

**Ref cat (08)**

- ZIALED.230V.14.CW
- ZIALED.230V.14.B
- ZIALED.230V.37.CW
- ZIALED.230V.37.B

build-in

**ZIALED/.. - Ø48**

=350mA   S2 IP44    0,0575  0,5 m  05.10.02 



build-in ceiling and wall light - without LED driver  
 Decken- und Wandleuchte für Einbau - ohne Driver LED

**Lamp type**

 powered 350mA . (1) 1W 350mA

**Dimensions**

 Ø58,5xH64

 Ø48  74

**Options**

S6.50/.. - PLASTERKIT

**Ref cat (08)**

- ZIALED.14.CW
- ZIALED.14.WW
- ZIALED.14.B
- ZIALED.37.CW
- ZIALED.37.WW
- ZIALED.37.B

build-in  
 clear glass + reflector on request  
 helles Glas + Reflektor auf Anfrage

**ZIAMINILED/.. - Ø29**

=350mA   IP44    0,0064  0,5 m  05.10.02 



build-in ceiling and wall light - without LED driver  
 Decken- und Wandleuchte für Einbau - ohne Driver LED

**Lamp type**

 powered 350mA . (1) 1W 350mA

**Dimensions**

 Ø38xH16

 Ø29  16

**Options**

S6.30/.. - PLASTERKIT

**Ref cat (08)**

- ZIAMINILED.1.CW
- ZIAMINILED.1.B
- ZIAMINILED.7.CW
- ZIAMINILED.7.B
- ZIAMINILED.11.CW
- ZIAMINILED.11.B
- ZIAMINILED.13.CW
- ZIAMINILED.13.B
- ZIAMINILED.14.CW
- ZIAMINILED.14.B
- ZIAMINILED.16.CW
- ZIAMINILED.16.B
- ZIAMINILED.36.CW
- ZIAMINILED.36.B

build-in  
 colour 36 IP44  
 Farbe 36 IP44

# INDOOR | Downlights | Ø29 | ZIA BASE Ø30 -M10-M6-M8-D8,3 | ZIA BASE Ø39-40 -M10-M6-M8-D8,3

LED colours: cold white (CW) warm white (WW) or blue (B) - other LED colours on request  
 LED Farben: kalt Weiß (CW) warm Weiß (WW) oder Blau (B) - andere LED Farben auf Anfrage

## ZIAMINI.C.LED/.. - Ø29

=350mA IP44 0,0129 0,5 m 05.10.02



build-in ceiling and wall light - without LED driver  
 Decken- und Wandleuchte für Einbau - ohne Driver LED

### Lamp type

powered 350mA . (1) 1W 350mA

### Dimensions

L40xB40xH16

Ø29 16

### Options

S6.30/.. - PLASTERKIT

### Ref cat (08)

- ZIAMINI.C.LED.1.CW
- ZIAMINI.C.LED.1.B
- ZIAMINI.C.LED.7.CW
- ZIAMINI.C.LED.7.B
- ZIAMINI.C.LED.11.CW
- ZIAMINI.C.LED.11.B
- ZIAMINI.C.LED.13.CW
- ZIAMINI.C.LED.13.B
- ZIAMINI.C.LED.14.CW
- ZIAMINI.C.LED.14.B
- ZIAMINI.C.LED.16.CW
- ZIAMINI.C.LED.16.B
- ZIAMINI.C.LED.36.CW
- ZIAMINI.C.LED.36.B

*build-in*  
 colour 36 IP44  
 Farbe 36 IP44

## 33/.. - ZIA BASE Ø30 -M10-M6-M8-D8,3

S1 IP20 0,0510



build-in base with swivel - without transformer  
 Einbaubasis mit Kugelgelenk - ohne Trafo

### Dimensions

Ø33xH55

Ø30

Colour	33D8,3/..	33M10/..	33M6/..	33M8/..
1				
1M				
2				
4				
7				
11				
13				
14				
16				
18				

*build-in*  
 ex. 33M6/16 + jazz 9010/16

## 43/.. - ZIA BASE Ø39-40 -M10-M6-M8-D8,3

S1 IP20 0,0800



build-in base with swivel - without transformer  
 Einbaubasis mit Kugelgelenk - ohne Trafo

### Dimensions

Ø43xH50

Ø39-40

Colour	43D8,3/..	43M10/..	43M6/..	43M8/..
1				
1M				
2				
4				
7				
11				
13				
14				
16				
18				

*build-in*  
 ex. 43M8/14 + step 6310/14

33M/.. Ø30

inbouwbasis met bolgewricht - base encastrable avec rotule - Einbaubasis mit Kugelgelenk

43M/.. Ø39-40



**stang - tige - rod**

**stang - tige M6 - M8 x 0,75 - M10 - D8,3**

**stang - tige - rod**

33M6/.. M6

jazz - cocktail - colibri - tuba (mess)

43M6/.. M6

33M8/.. M8

step - jupiter - utopie - globo - zumba - domino  
capri - condor - folio - volta - viola - discus  
discovery - apollo - saturno - flash - tuba (alu)

43M8/.. M8

33M10/.. M10

twist

43M10/.. M10

33D8,3/..

43D8,3/..

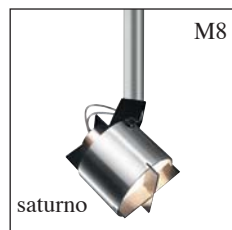
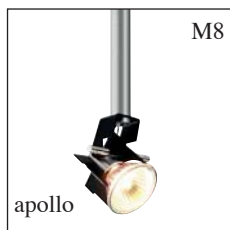
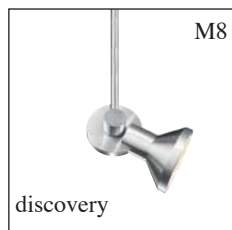
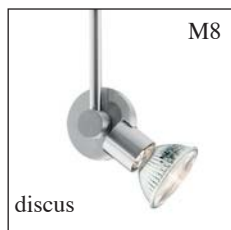
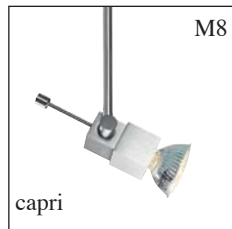
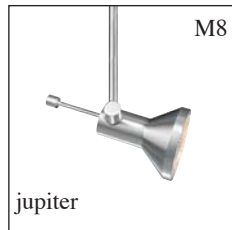

spots in verschillende lengtes verkrijgbaar - spots disponibles en différentes longueurs  
spots available in different lengths - Strahler verfügbar in verschiedenen Längen.



ARCA35/.. - Ø60

~12V S2 IP20 0,1111 0,5 m 05.10.02



downlight - round - fixed - without transformer  
Einbaustrahler - rund - fest - ohne Trafo

Ref cat (CAS)

Lamp type

QR-CB 35 GU4/GZ4 (1) 35W 12V

Dimensions

Ø72xH50

Ø60  $\sqrt{L}$  70

Options

S6.60/.. - PLASTERKIT

ARCA35.1  
ARCA35.1M  
ARCA35.2  
ARCA35.4  
ARCA35.7  
ARCA35.11  
ARCA35.13  
ARCA35.14  
ARCA35.16

build-in

ARCA50/.. - Ø72-75

~12V S2 IP20 0,1300 0,5 m 05.10.02



downlight - round - fixed - without transformer  
Einbaustrahler - rund - fest - ohne Trafo

Ref cat (CAS)

Lamp type

QR-CB 51 GU5,3/GX5,3 (1) 50W 12V

Dimensions

Ø87xH62

Ø72-75  $\sqrt{L}$  82

Options

S6.75/.. - PLASTERKIT

ARCA50.1  
ARCA50.1M  
ARCA50.2  
ARCA50.4  
ARCA50.7  
ARCA50.11  
ARCA50.13  
ARCA50.14  
ARCA50.16

build-in

FOCUS35/.. - Ø49

~12V S2 IP20 0,0878 0,5 m 05.10.02



downlight - round - fixed - without transformer  
Einbaustrahler - rund - fest - ohne Trafo

Ref cat (CAS)

Lamp type

QR-CB 35 GU4/GZ4 (1) 35W 12V

Dimensions

Ø59xH50

Ø49  $\sqrt{L}$  70

Options

S6.50/.. - PLASTERKIT

FOCUS35.1  
FOCUS35.1M  
FOCUS35.2  
FOCUS35.4  
FOCUS35.7  
FOCUS35.11  
FOCUS35.13  
FOCUS35.14  
FOCUS35.16

build-in

FOCUS50/.. - Ø64

~12V S2 IP20 0,1189 0,5 m 05.10.02



downlight - round - fixed - without transformer  
Einbaustrahler - rund - fest - ohne Trafo

Ref cat (CAS)

Lamp type

QR-CB 51 GU5,3/GX5,3 (1) 50W 12V

Dimensions

Ø78xH60

Ø64  $\sqrt{L}$  82

Options

S6.65/.. - PLASTERKIT

FOCUS50.1  
FOCUS50.1M  
FOCUS50.2  
FOCUS50.4  
FOCUS50.7  
FOCUS50.11  
FOCUS50.13  
FOCUS50.14  
FOCUS50.16

build-in

## INDOOR | Downlights | Ø65-70 INOX 316 | FITTING

Adjust the wattage to the type of ceiling (concrete, wood, PVC, etc).

Wattleistung auf den Typ der Decke abstimmen (Beton, Holz, PVC, usw)

### 301V/.. - Ø65-70 INOX 316

~12V



S2

IP20



0,1409

0,5 m



05.10.02



downlight - round - fixed - without transformer  
Einbaustrahler - rund - fest - ohne Trafo

#### Lamptype

QR-CB 51 GU5,3/GX5,3 (1) 50W 12V

#### Dimensions

Ø85xH55

Ø65-70 75

#### Options

S6.65/.. - PLASTERKIT

#### Ref cat (CAS)

301V.5  
301V.5B  
301V.5BB  
301V.31  
301V.32  
301V.33

#### build-in

Code 5BB for application in coastal areas!!  
Kode 5BB anzuwenden in der Küstengegend!!

### 302V/.. - Ø65-70 INOX 316

~12V



S2

IP20



0,1400

0,5 m



05.10.02



downlight - round - fixed - without transformer  
Einbaustrahler - rund - fest - ohne Trafo

#### Lamptype

QR-CB 51 GU5,3/GX5,3 (1) 50W 12V

#### Dimensions

Ø85xH55

Ø65-70 75

#### Options

S6.65/.. - PLASTERKIT

#### Ref cat (CAS)

302V.5  
302V.5B  
302V.5BB  
302V.31  
302V.32  
302V.33

#### build-in

Code 5BB for application in coastal areas!!  
Kode 5BB anzuwenden in der Küstengegend!!

### 303V/.. - Ø65-70 INOX 316

~12V



S2

IP20



0,1436

0,5 m



05.10.02



downlight - square - fixed - without transformer  
Einbaustrahler - viereckig - fest - ohne Trafo

#### Lamptype

QR-CB 51 GU5,3/GX5,3 (1) 50W 12V

#### Dimensions

L85xB85xH55

Ø65-70 75

#### Options

S6.65/.. - PLASTERKIT

#### Ref cat (CAS)

303V.5  
303V.5B  
303V.5BB  
303V.31  
303V.32  
303V.33

#### build-in

Code 5BB for application in coastal areas!!  
Kode 5BB anzuwenden in der Küstengegend!!

### 300V/./12V - FITTING

~12V



IP44



0,0400

1 m



05.10.02



supplement for downlight - waterproof fitting  
Supplement für Einbaustrahler - wasserdichte Fassung

#### Lamptype

QR-CB 51 GU5,3/GX5,3 (1) 50W 12V

#### Ref cat (XX)

300V.12V



Adjust the wattage to the type of ceiling (concrete, wood, PVC, etc).

Wattleistung auf den Typ der Decke abstimmen (Beton, Holz, PVC, usw)

**301V.230V/.. - Ø65-70 INOX 316**

~230V  S2 IP20    0,2100  1 m  05.10.02 





downlight - round - fixed  
Einbaustrahler - rund - fest

**Lamptype**

 QPAR 51 GU10 (1) 50W 230V  
or  QPAR 51 GU10 (1) 11W 230V

**Dimensions**

 Ø85xH85  
 Ø65-70  100

**Options**

S6.65/.. - PLASTERKIT

**Ref cat (CAS)**

301V.230V.5  
301V.230V.5B  
301V.230V.5BB  
301V.230V.31  
301V.230V.32  
301V.230V.33

**build-in**

Code 5BB for application in coastal areas!!  
Kode 5BB anzuwenden in der Küstengegend!!

**302V.230V/.. - Ø65-70 INOX 316**

~230V  S2 IP20    0,2100  1 m  05.10.02 





downlight - round - fixed  
Einbaustrahler - rund - fest

**Lamptype**

 QPAR 51 GU10 (1) 50W 230V  
or  QPAR 51 GU10 (1) 11W 230V

**Dimensions**

 Ø85xH85  
 Ø65-70  100

**Options**

S6.65/.. - PLASTERKIT

**Ref cat (CAS)**

302V.230V.5  
302V.230V.5B  
302V.230V.5BB  
302V.230V.31  
302V.230V.32  
302V.230V.33

**build-in**

Code 5BB for application in coastal areas!!  
Kode 5BB anzuwenden in der Küstengegend!!

**303V.230V/.. - Ø65-70 INOX 316**

~230V  S2 IP20    0,2300  1 m  05.10.02 





downlight - square - fixed  
Einbaustrahler - viereckig - fest

**Lamptype**

 QPAR 51 GU10 (1) 50W 230V  
or  QPAR 51 GU10 (1) 11W 230V

**Dimensions**

 L85xB85xH85  
 Ø65-70  100

**Options**

S6.65/.. - PLASTERKIT

**Ref cat (CAS)**

303V.230V.5  
303V.230V.5B  
303V.230V.5BB  
303V.230V.31  
303V.230V.32  
303V.230V.33

**build-in**

Code 5BB for application in coastal areas!!  
Kode 5BB anzuwenden in der Küstengegend!!

**300V../230V - FITTING**

~230V  IP44    0,0400  1 m  05.10.02 



supplement for downlight - waterproof fitting  
Supplement für Einbaustrahler - wasserdichte Fassung

**Lamptype**

 QPAR 51 GU10 (1) 50W 230V  
or  QPAR 51 GU10 (1) 11W 230V

**Ref cat (XX)**

300V.230V

**VARIO35/.. - Ø65**

~12V S2 IP20 0,1300 0,5 m 05.10.02



downlight - square - directional - without transformer  
Einbaustrahler - viereckig - schwenkbar - ohne Trafo

**Lamptype**

QR-CB 35 GU4/GZ4 (1) 35W 12V

**Dimensions**

L87x87xH65

Ø65 85

**Options**

S6.65/.. - PLASTERKIT

**Ref cat (CAS)**

VARIO35.1  
VARIO35.1M  
VARIO35.2  
VARIO35.11  
VARIO35.14

build-in

**VARIO2X35/.. - 2xØ65**

~12V S2 IP20 0,2500 0,5 m 05.10.02



downlight - square - directional - without transformer  
Einbaustrahler - viereckig - schwenkbar - ohne Trafo

**Lamptype**

QR-CB 35 GU4/GZ4 (2) 35W 12V

**Dimensions**

L162x87xH65

2xØ65 85 [78]

**Options**

S7.65V/.. - PLASTERKIT

**Ref cat (CAS)**

VARIO2X35.1  
VARIO2X35.1M  
VARIO2X35.2  
VARIO2X35.11  
VARIO2X35.14

build-in

**PICO20/.. - Ø65**

~12V S2 IP20 0,1654 0,5 m 05.10.02



downlight - round - fixed - without transformer  
Einbaustrahler - rund - fest - ohne Trafo

**Lamptype**

QR-CB 35 GU4/GZ4 (1) 20W 12V

**Dimensions**

Ø75xH43

Ø65 63

**Options**

S6.65/.. - PLASTERKIT

**Ref cat (CAS)**

PICO20.5  
PICO20.5B  
PICO20.31  
PICO20.32  
PICO20.33

build-in  
Max. 20W

PICO35/.. - Ø65

~12V S2 IP20 0,1269 0,5 m 05.10.02



downlight - round - fixed - without transformer  
Einbaustrahler - rund - fest - ohne Trafo

**Lamptype**

QR-CB 35 GU4/GZ4 (1) 35W 12V

**Dimensions**

Ø75xH43  
 Ø65 63

**Options**

S6.65/.. - PLASTERKIT

**Ref cat (CAS)**

- PICO35.1
- PICO35.1M
- PICO35.2
- PICO35.4
- PICO35.7
- PICO35.11
- PICO35.11S
- PICO35.13
- PICO35.14
- PICO35.16
- PICO35.18
- PICO35.23
- PICO35.25

build-in

PICO35DOWN/.. - Ø65

~12V S2 IP20 0,1550 0,5 m 05.10.02



downlight - round - fixed - without transformer  
Einbaustrahler - rund - fest - ohne Trafo

**Lamptype**

QR-CB 35 GU4/GZ4 (1) 35W 12V

**Dimensions**

Ø75xH62  
 Ø65 82

**Options**

S6.65/.. - PLASTERKIT

**Ref cat (CAS)**

- PICO35DOWN.1
- PICO35DOWN.1M
- PICO35DOWN.2
- PICO35DOWN.4
- PICO35DOWN.5
- PICO35DOWN.7
- PICO35DOWN.11
- PICO35DOWN.13
- PICO35DOWN.14
- PICO35DOWN.16
- PICO35DOWN.18
- PICO35DOWN.25

build-in

SIRA35CH/.. - Ø65

~12V S2 IP20 0,1350 0,5 m 05.10.02



downlight - round - fixed - without transformer  
Einbaustrahler - rund - fest - ohne Trafo

**Lamptype**

QR-CB 35 GU4/GZ4 (1) 35W 12V

**Dimensions**

Ø75xH70  
 Ø65 90

**Options**

S6.65/.. - PLASTERKIT

**Ref cat (CAS)**

- SIRA35CH.1
- SIRA35CH.1M
- SIRA35CH.2
- SIRA35CH.4
- SIRA35CH.5
- SIRA35CH.7
- SIRA35CH.11
- SIRA35CH.13
- SIRA35CH.14
- SIRA35CH.16
- SIRA35CH.18

build-in

SIRA35M/.. - Ø65

~12V



S2

IP20



0,1273

0,5 m

05.10.02



downlight - round - fixed - without transformer  
Einbaustrahler - rund - fest - ohne Trafo

**Lamp type**

QR-CB 35 GU4/GZ4 (1) 35W 12V

**Dimensions**

Ø75xH70

Ø65 90

**Options**

S6.65/.. - PLASTERKIT

**Ref cat (CAS)**

- SIRA35M.1
- SIRA35M.1M
- SIRA35M.2
- SIRA35M.4
- SIRA35M.5
- SIRA35M.7
- SIRA35M.11
- SIRA35M.13
- SIRA35M.14
- SIRA35M.16
- SIRA35M.18

build-in

DIVA35/.. - Ø65

~12V



S2

IP20



0,1556

0,5 m

05.10.02



downlight - round - directional - without transformer  
Einbaustrahler - rund - schwenkbar - ohne Trafo

**Lamp type**

QR-CB 35 GU4/GZ4 (1) 35W 12V

**Dimensions**

Ø75xH48

Ø65 68

**Options**

S6.65/.. - PLASTERKIT

**Ref cat (CAS)**

- DIVA35.1
- DIVA35.1M
- DIVA35.2
- DIVA35.4
- DIVA35.5
- DIVA35.5B
- DIVA35.7
- DIVA35.11
- DIVA35.13
- DIVA35.14
- DIVA35.16
- DIVA35.18
- DIVA35.20
- DIVA35.23
- DIVA35.25
- DIVA35.31
- DIVA35.32
- DIVA35.33

build-in



ZENO35/.. - Ø65 - M10



build-in base for spotlight or pendant - round - without transformer  
Einbaubasis für Aufbaustrahler oder Pendelleuchte - rund - ohne Trafo

**Dimensions**

→ Ø75xH33  
↙ Ø65 ↘ 40

**Options**

S6.65/.. - PLASTERKIT

**Ref cat (BAS)**

- ZENO35.1
- ZENO35.1M
- ZENO35.2
- ZENO35.4
- ZENO35.7
- ZENO35.11
- ZENO35.13
- ZENO35.14
- ZENO35.16
- ZENO35.18

build-in

ZENO35B3/.. - Ø65 - B3

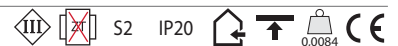

build-in base for pendant with swivel - round - without transformer  
Einbaubasis für Pendelleuchte mit Kugelgelenk - rund - ohne Trafo

**Dimensions**

→ Ø75xH33  
↙ Ø65 ↘ 40

**Options**

S6.65/.. - PLASTERKIT

**Ref cat (BAS)**

- ZENO35B3.1
- ZENO35B3.1M
- ZENO35B3.2
- ZENO35B3.4
- ZENO35B3.7
- ZENO35B3.11
- ZENO35B3.13
- ZENO35B3.14
- ZENO35B3.16
- ZENO35B3.18

build-in  
Max. 300gr

CANO35/.. - Ø65



downlight - round - fixed - without transformer  
Einbaustrahler - rund - fest - ohne Trafo

**Lamptype**

☞ QR-CB 35 GU4/GZ4 (1) 35W 12V

**Dimensions**

→ Ø75xH33  
↙ Ø65 ↘ 53

**Options**

S6.65/.. - PLASTERKIT

**Ref cat (CAS)**

- CANO35.1
- CANO35.1M
- CANO35.2
- CANO35.4
- CANO35.7
- CANO35.11
- CANO35.13
- CANO35.14
- CANO35.16
- CANO35.18

semi build in/up

Ø 65 SYSTEM

BASES



single65



twin65

CASSETTES



caspico35



caspicodown35



casdiva35



caszeno35

spot of pendel afzonderlijk te bestellen  
spot ou suspension à commander séparément  
spot or pendant to order separately  
Spot oder Pendelleuchte separat bestellen



cascano35



cassira35



caszeno35.B3

pendel met bolgewricht B3 afzonderlijk te bestellen  
suspension avec rotule B3 à commander séparément  
pendant with B3 swivel to order separately  
Pendelleuchte B3 separat bestellen

SINGLE65/.. - Ø65

S2 IP20 0,0600



build-in base for cassette - square  
Einbaubasis für Kassette - viereckig

Dimensions

L75xB75xH33

Ø65

Options

S6.65/.. - PLASTERKIT

Ref cat (BAS)

SINGLE65.1  
SINGLE65.1M  
SINGLE65.2  
SINGLE65.11  
SINGLE65.14

build-in

TWIN65/.. - 2xØ65

S2 IP20 0,1100



build-in base for cassette - square  
Einbaubasis für Kassette - viereckig

Dimensions

L142xB75xH33

2xØ65 [68]

Options

S7.65/.. - PLASTERKIT

Ref cat (BAS)

TWIN65.1  
TWIN65.1M  
TWIN65.2  
TWIN65.11  
TWIN65.14

build-in

CASPICO35/.. - Ø65 SYSTEM



build-in cassette - fixed - without transformer  
Einbaukassette - fest - ohne Trafo

Lamptype

QR-CB 35 GU4/GZ4 (1) 35W 12V

Dimensions

H43

~12V III IP20 0,0300 0,5 m 05.10.02 CE

Ref cat (CAS)

CASPICO35.1  
CASPICO35.1M  
CASPICO35.2  
CASPICO35.11  
CASPICO35.14

CASPICODWN35/.. - Ø65 SYSTEM



build-in cassette - fixed - without transformer  
Einbaukassette - fest - ohne Trafo

Lamptype

QR-CB 35 GU4/GZ4 (1) 35W 12V

Dimensions

H62

~12V III IP20 0,0400 0,5 m 05.10.02 CE

Ref cat (CAS)

CASPICODWN35.1  
CASPICODWN35.1M  
CASPICODWN35.2  
CASPICODWN35.11  
CASPICODWN35.14

CASDIVA35/.. - Ø65 SYSTEM



build-in cassette - directional - without transformer  
Einbaukassette - schwenkbar - ohne Trafo

Lamptype

QR-CB 35 GU4/GZ4 (1) 35W 12V

Dimensions

H48

~12V III IP20 0,0700 0,5 m 05.10.02 CE

Ref cat (CAS)

CASDIVA35.1  
CASDIVA35.1M  
CASDIVA35.2  
CASDIVA35.11  
CASDIVA35.14

CASCANO35/.. - Ø65 SYSTEM



build-in cassette - fixed - without transformer  
Einbaukassette - fest - ohne Trafo

Lamptype

QR-CB 35 GU4/GZ4 (1) 35W 12V

Dimensions

H33

~12V III IP20 0,0400 0,5 m 05.10.02 CE

Ref cat (CAS)

CASCANO35.1  
CASCANO35.1M  
CASCANO35.2  
CASCANO35.11  
CASCANO35.14

semi build in/up

**CASSIRA35/.. - Ø65 SYSTEM**

~12V



build-in cassette - fixed - without transformer  
Einbaukassette - fest - ohne Trafo

**Lamptype**

QR-CB 35 GU4/GZ4 (1) 35W 12V

**Dimensions**

↔ H70

**Ref cat (CAS)**

CASSIRA35.7  
CASSIRA35.14

**CASZENO35.B3/.. - Ø65 SYSTEM - B3**



build-in cassette for pendant with swivel - without transformer  
Einbaukassette für Pendelleuchte mit Kugelgelenk - ohne Trafo

**Dimensions**

↔ H33

**Ref cat (BAS)**

CASZENO35.B3.1  
CASZENO35.B3.1M  
CASZENO35.B3.2  
CASZENO35.B3.11  
CASZENO35.B3.14

Max. 300gr

**CASZENO35/.. - Ø65 SYSTEM - M10**



build-in cassette for spotlight or pendant - without transformer  
Einbaukassette für Aufbaustrahler oder Pendelleuchte - ohne Trafo

**Dimensions**

↔ H33

**Ref cat (BAS)**

CASZENO35.1  
CASZENO35.1M  
CASZENO35.2  
CASZENO35.11  
CASZENO35.14

**DISCO/.. - Ø70**

~12V



downlight - round - directional - without transformer  
Einbaustrahler - rund - schwenkbar - ohne Trafo

**Lamptype**

QR-CB 51 GU5,3/GX5,3 (1) 50W 12V

**Dimensions**

↔ Ø80xH75

Ø70 95

**Options**

S6.70/.. - PLASTERKIT

**Ref cat (CAS)**

DISCO.1  
DISCO.1M  
DISCO.2  
DISCO.4  
DISCO.7  
DISCO.11  
DISCO.13  
DISCO.14  
DISCO.16  
DISCO.18  
DISCO.25

build-in



**YOKO/.. - Ø70**

~12V S2 IP20 0,1818 0,5 05.10.02



downlight - round - fixed - without transformer  
Einbaustrahler - rund - fest - ohne Trafo

**Lamptype**

QR-CB 51 GU5,3/GX5,3 (1) 50W 12V

**Dimensions**

Ø80xH75  
Ø70 JL 95

**Options**

S6.70/.. - PLASTERKIT

**Ref cat (CAS)**

- YOKO.1
- YOKO.1M
- YOKO.2
- YOKO.4
- YOKO.7
- YOKO.11
- YOKO.13
- YOKO.14
- YOKO.16
- YOKO.18
- YOKO.25

build-in

**ONO/.. - Ø70 - M10**

S2 IP20 0,1491



build-in base for spotlight or pendant - round - without transformer  
Einbaubasis für Aufbaustrahler oder Pendelleuchte - rund - ohne Trafo

**Dimensions**

Ø80xH33  
Ø70 JL 40

**Options**

S6.70/.. - PLASTERKIT

**Ref cat (BAS)**

- ONO.1
- ONO.1M
- ONO.2
- ONO.4
- ONO.7
- ONO.11
- ONO.13
- ONO.14
- ONO.16
- ONO.18
- ONO.25

build-in

**DISCO.ES50/.. - Ø70**

~230V S2 IP20 0,2282 1 m 05.10.02



downlight - round - directional  
Einbaustrahler - rund - schwenkbar

**Lamptype**

QPAR 51 GU10 (1) 50W 230V  
or QPAR 51 GU10 (1) 11W 230V

**Dimensions**

Ø80xH85  
Ø70 JL 105

**Options**

S6.70/.. - PLASTERKIT

**Ref cat (CAS)**

- DISCO.ES50.1
- DISCO.ES50.1M
- DISCO.ES50.2
- DISCO.ES50.4
- DISCO.ES50.7
- DISCO.ES50.11
- DISCO.ES50.13
- DISCO.ES50.14
- DISCO.ES50.16
- DISCO.ES50.18
- DISCO.ES50.25

build-in

**YOKO.ES50/.. - Ø70**

~230V S2 IP20 0,2257 1 m 05.10.02



downlight - round - fixed  
Einbaustrahler - rund - fest

**Lamptype**

QPAR 51 GU10 (1) 50W 230V  
or QPAR 51 GU10 (1) 11W 230V

**Dimensions**

Ø80xH85  
Ø70 JL 105

**Options**

S6.70/.. - PLASTERKIT

**Ref cat (CAS)**

- YOKO.ES50.1
- YOKO.ES50.1M
- YOKO.ES50.2
- YOKO.ES50.4
- YOKO.ES50.7
- YOKO.ES50.11
- YOKO.ES50.13
- YOKO.ES50.14
- YOKO.ES50.16
- YOKO.ES50.18
- YOKO.ES50.25

build-in

Ø 70 SYSTEM

BASES



single70



twin70

CASSETTES



casdisco - casdisco.  
ES50



casyoko - casyoko.  
ES50



casono

spot of pendel afzonderlijk te bestellen  
spot ou suspension à commander séparément  
spot or pendant to order separately  
Spot oder Pendelleuchte separat bestellen

SINGLE70/.. - Ø70

S2 IP20 0,0600



build-in base for cassette - square  
Einbaubasis für Kassette - viereckig

Dimensions

L80xB80xH33

Ø70

Options

S6.70/.. - PLASTERKIT

Ref cat (BAS)

- SINGLE70.1
- SINGLE70.1M
- SINGLE70.2
- SINGLE70.7
- SINGLE70.11
- SINGLE70.14
- SINGLE70.18

build-in

TWIN70/.. - 2xØ70

S2 IP20 0,1100



build-in base for cassette - square  
Einbaubasis für Kassette - viereckig

Dimensions

L155xB80xH33

2xØ70 [78]

Options

S7.70/.. - PLASTERKIT

Ref cat (BAS)

- TWIN70.1
- TWIN70.1M
- TWIN70.2
- TWIN70.7
- TWIN70.11
- TWIN70.14
- TWIN70.18

build-in

CASDISCO/.. - Ø70 SYSTEM

~12V IP20 0,0850 0,5 m 05.10.02



build-in cassette - directional - without transformer  
Einbaukassette - schwenkbar - ohne Trafo

**Lamp type**  
QR-CB 51 GU5,3/GX5,3 (1) 50W 12V

**Dimensions**  
H75

**Ref cat (CAS)**

- CASDISCO.1
- CASDISCO.1M
- CASDISCO.2
- CASDISCO.7
- CASDISCO.11
- CASDISCO.14
- CASDISCO.18
- CASDISCO.25

CASYOKO/.. - Ø70 SYSTEM

~12V IP20 0,0914 0,5 m 05.10.02



build-in cassette - fixed - without transformer  
Einbaukassette - fest - ohne Trafo

**Lamp type**  
QR-CB 51 GU5,3/GX5,3 (1) 50W 12V

**Dimensions**  
H75

**Ref cat (CAS)**

- CASYOKO.1
- CASYOKO.1M
- CASYOKO.2
- CASYOKO.7
- CASYOKO.11
- CASYOKO.14
- CASYOKO.18

CASONO/.. - Ø70 SYSTEM - M10

IP20 0,0400



build-in cassette for spotlight or pendant - without transformer  
Einbaukassette für Aufbaustrahler oder Pendelleuchte - ohne Trafo

**Dimensions**  
H33

**Ref cat (BAS)**

- CASONO.1
- CASONO.1M
- CASONO.2
- CASONO.7
- CASONO.11
- CASONO.14
- CASONO.18

CASDISCO.ES50/.. - Ø70 SYSTEM

~230V IP20 0,0800 1 m 05.10.02



build-in cassette - directional  
Einbaukassette - schwenkbar

**Lamp type**  
QPAR 51 GU10 (1) 50W 230V  
or QPAR 51 GU10 (1) 11W 230V

**Dimensions**  
H85

**Ref cat (CAS)**

- CASDISCO.ES50.1
- CASDISCO.ES50.1M
- CASDISCO.ES50.2
- CASDISCO.ES50.7
- CASDISCO.ES50.11
- CASDISCO.ES50.14
- CASDISCO.ES50.18

CASYOKO.ES50/.. - Ø70 SYSTEM

~230V



build-in cassette - fixed  
Einbaukassette - fest

**Lamptype**

QPAR 51 GU10 (1) 50W 230V  
or QPAR 51 GU10 (1) 11W 230V

**Dimensions**

H85

**Ref cat (CAS)**

CASYOKO.ES50.1  
CASYOKO.ES50.1M  
CASYOKO.ES50.2  
CASYOKO.ES50.7  
CASYOKO.ES50.11  
CASYOKO.ES50.14  
CASYOKO.ES50.18

PICO50/.. - Ø80

~12V



downlight - round - fixed - without transformer  
Einbaustrahler - rund - fest - ohne Trafo

**Lamptype**

QR-CB 51 GU5,3/GX5,3 (1) 50W 12V

**Dimensions**

Ø89xH55

Ø80 75

**Options**

S1/.. - TORSION SPRINGS  
S6.80/.. - PLASTERKIT

**Ref cat (CAS)**

PICO50.1  
PICO50.1M  
PICO50.2  
PICO50.4  
PICO50.5  
PICO50.5B  
PICO50.5BB  
PICO50.7  
PICO50.11  
PICO50.11S  
PICO50.13  
PICO50.14  
PICO50.16  
PICO50.18  
PICO50.20  
PICO50.21  
PICO50.23  
PICO50.25  
PICO50.31  
PICO50.32  
PICO50.33  
PICO50.40

build-in

PICODOWN50/.. - Ø80

~12V S2 IP20 0,1650 0,5 m 05.10.02



downlight - round - fixed - without transformer  
Einbaustrahler - rund - fest - ohne Trafo

**Lamptype**

QR-CB 51 GU5,3/GX5,3 (1) 50W 12V

**Dimensions**

Ø89xH70

Ø80 ∟ 90

**Options**

S6.80/.. - PLASTERKIT

**Ref cat (CAS)**

- PICODOWN50.1
- PICODOWN50.1M
- PICODOWN50.2
- PICODOWN50.4
- PICODOWN50.5
- PICODOWN50.7
- PICODOWN50.11
- PICODOWN50.13
- PICODOWN50.14
- PICODOWN50.16
- PICODOWN50.18
- PICODOWN50.25

build-in

PICODOWNRING/.. - PICODOWNRING

IP20 0,0085



supplement  
Supplement

**Ref cat (XX)**

- PICODOWNRING.1M
- PICODOWNRING.2

DIVA50/.. - Ø80

~12V S2 IP20 0,1962 0,5 m 05.10.02



downlight - round - directional - without transformer  
Einbaustrahler - rund - schwenkbar - ohne Trafo

**Lamptype**

QR-CB 51 GU5,3/GX5,3 (1) 50W 12V

**Dimensions**

Ø89xH62

Ø80 ∟ 82

**Options**

S1/.. - TORSION SPRINGS

S6.80/.. - PLASTERKIT

**Ref cat (CAS)**

- DIVA50.1
- DIVA50.1M
- DIVA50.2
- DIVA50.4
- DIVA50.5
- DIVA50.5B
- DIVA50.5BB
- DIVA50.7
- DIVA50.11
- DIVA50.13
- DIVA50.14
- DIVA50.16
- DIVA50.18
- DIVA50.21
- DIVA50.23
- DIVA50.25
- DIVA50.31
- DIVA50.32
- DIVA50.33

build-in

**AQUANODOTIP44/.. - Ø80**

~12V S2 IP44 0,1800 0,5 m 05.10.02



downlight - round - fixed - without transformer  
Einbaustrahler - rund - fest - ohne Trafo

**Lamptype**

QR-CB 51 GU5,3/GX5,3 (1) 50W 12V

**Dimensions**

Ø89xH80  
 Ø80 100

**Options**

S6.80/.. - PLASTERKIT

**Ref cat (CAS)**

AQUANODOTIP44.1S  
AQUANODOTIP44.11S  
AQUANODOTIP44.2S

build-in  
bathrooms - showers  
Badezimmer - Duschen

**CANO50/.. - Ø80**

~12V S2 IP20 0,2060 0,5 m 05.10.02



downlight - round - fixed - without transformer  
Einbaustrahler - rund - fest - ohne Trafo

**Lamptype**

QR-CB 51 coolfit GU5,3/GX5,3 (1) 50W 12V

**Dimensions**

Ø89xH33  
 Ø80 50

**Options**

S6.80/.. - PLASTERKIT

**Ref cat (CAS)**

CANO50.1  
CANO50.1M  
CANO50.2  
CANO50.4  
CANO50.7  
CANO50.11  
CANO50.13  
CANO50.14  
CANO50.16  
CANO50.18

semi build in/up  
use coolfit lamp  
Coolfit-Lampe verwenden

**VIDRIO50/.. - Ø80**

~12V S2 IP20 0,1481 0,5 m 05.10.02



downlight - round - without transformer  
Einbaustrahler - rund - ohne Trafo

**Lamptype**

QR-CB 51 GU5,3/GX5,3 (1) 50W 12V

**Dimensions**

Ø89xH135  
 Ø80 75

**Options**

S6.80/.. - PLASTERKIT  
VIDRIOGLASS/.. - CONVERTIBLE SYSTEM

**Ref cat (CAS)**

VIDRIO50.1  
VIDRIO50.1M  
VIDRIO50.2  
VIDRIO50.4  
VIDRIO50.7  
VIDRIO50.11  
VIDRIO50.13  
VIDRIO50.14  
VIDRIO50.16  
VIDRIO50.18

build-in  
glass Ø50xH84  
Glas Ø50xH84

**VIDRIOGLASS/.. - CONVERTIBLE SYSTEM**

IP20 0,0850



accessory for downlight  
Zubehör für Einbaustrahler

**Dimensions**

Ø50xH84

**Ref cat (XX)**

VIDRIOGLASS

**SIRA50CH/.. - Ø80**

~12V S2 IP20 0,1642 0,5 m 05.10.02



downlight - round - fixed - without transformer  
Einbaustrahler - rund - fest - ohne Trafo

**Lamp type**

QR-CB 51 GU5,3/GX5,3 (1) 50W 12V

**Dimensions**

Ø89xH80  
Ø80 100

**Options**

S6.80/.. - PLASTERKIT

**Ref cat (CAS)**

- SIRA50CH.1
- SIRA50CH.1M
- SIRA50CH.2
- SIRA50CH.4
- SIRA50CH.5
- SIRA50CH.7
- SIRA50CH.11
- SIRA50CH.13
- SIRA50CH.14
- SIRA50CH.16
- SIRA50CH.18
- SIRA50CH.25

build-in  
CH = chrome reflector  
CH = Chromreflektor

**SIRA50M/.. - Ø80**

~12V S2 IP20 0,1662 0,5 m 05.10.02



downlight - round - fixed - without transformer  
Einbaustrahler - rund - fest - ohne Trafo

**Lamp type**

QR-CB 51 GU5,3/GX5,3 (1) 50W 12V

**Dimensions**

Ø89xH80  
Ø80 100

**Options**

S6.80/.. - PLASTERKIT

**Ref cat (CAS)**

- SIRA50M.1
- SIRA50M.1M
- SIRA50M.2
- SIRA50M.4
- SIRA50M.5
- SIRA50M.7
- SIRA50M.11
- SIRA50M.13
- SIRA50M.14
- SIRA50M.16
- SIRA50M.18
- SIRA50M.25

build-in  
M = mat chrome reflector  
M = Chromreflektor matt

**ZENO50/.. - Ø80 - M10**

S2 IP20 0,1073



build-in base for spotlight or pendant - round - without transformer  
Einbaubasis für Aufbaustrahler oder Pendelleuchte - rund - ohne Trafo

**Dimensions**

Ø89xH33  
Ø80 40

**Options**

S6.80/.. - PLASTERKIT

**Ref cat (BAS)**

- ZENO50.1
- ZENO50.1M
- ZENO50.2
- ZENO50.4
- ZENO50.7
- ZENO50.11
- ZENO50.13
- ZENO50.14
- ZENO50.16
- ZENO50.18
- ZENO50.25

build-in

**ZENO50B3/.. - Ø80 - B3**

S2 IP20 0,0096



build-in base for pendant with swivel - round - without transformer  
Einbaubasis für Pendelleuchte mit Kugelgelenk - rund - ohne Trafo

**Dimensions**

Ø89xH33  
Ø80 40

**Options**

S6.80/.. - PLASTERKIT

**Ref cat (BAS)**

- ZENO50B3.1
- ZENO50B3.1M
- ZENO50B3.2
- ZENO50B3.4
- ZENO50B3.7
- ZENO50B3.11
- ZENO50B3.13
- ZENO50B3.14
- ZENO50B3.16
- ZENO50B3.18
- ZENO50B3.25

build-in  
Max. 300gr

**DIVA50/.../LN - Ø80 PUNCHED**

~12V S2 IP20 0,0678 0,5 m 05.10.02



downlight punched - round - directional - without transformer  
Einbaustrahler gestanz - rund - schwenkbar - ohne Trafo

**Lamptype**

QR-CB 51 GU5,3/GX5,3 (1) 50W 12V

**Dimensions**

Ø89xH62

Ø80 82

**Options**

S6.80/.. - PLASTERKIT

**Ref cat (CAS)**

- DIVA50.1.LN
- DIVA50.1M.LN
- DIVA50.2.LN
- DIVA50.4.LN
- DIVA50.5.LN
- DIVA50.5B.LN
- DIVA50.5BB.LN
- DIVA50.7.LN
- DIVA50.11.LN
- DIVA50.13.LN
- DIVA50.14.LN
- DIVA50.16.LN
- DIVA50.30.LN

**build-in**  
not compatible with adaption ring and torsion springs!  
nicht verwendbar mit Adapterring und Torsionfedern!

**PICO50/.../LN - Ø80 PUNCHED**

~12V S2 IP20 0,1180 0,5 m 05.10.02



downlight punched - round - fixed - without transformer  
Einbaustrahler gestanz - rund - fest - ohne Trafo

**Lamptype**

QR-CB 51 GU5,3/GX5,3 (1) 50W 12V

**Dimensions**

Ø89xH55

Ø80 75

**Options**

S6.80/.. - PLASTERKIT

**Ref cat (CAS)**

- PICO50.1.LN
- PICO50.1M.LN
- PICO50.2.LN
- PICO50.4.LN
- PICO50.5.LN
- PICO50.5B.LN
- PICO50.5BB.LN
- PICO50.7.LN
- PICO50.11.LN
- PICO50.13.LN
- PICO50.14.LN
- PICO50.16.LN
- PICO50.30.LN

**build-in**  
not compatible with adaption ring and torsion springs!  
nicht verwendbar mit Adapterring und Torsionfedern!



**DIVA50.ESS0/./LN - Ø80 PUNCHED**

~230V  S2 IP20    0,0929  1 m  05.10.02 





downlight punched - round - directional  
Einbaustrahler gestanz - rund - schwenkbar

**Lamptype**

 QPAR 51 GU10 (1) 50W 230V  
or  QPAR 51 GU10 (1) 11W 230V

**Dimensions**

 Ø89xH115  
 Ø80  135

**Options**

S6.80/.. - PLASTERKIT

**Ref cat (CAS)**

- DIVA50.ESS0.1.LN
- DIVA50.ESS0.1M.LN
- DIVA50.ESS0.2.LN
- DIVA50.ESS0.4.LN
- DIVA50.ESS0.5.LN
- DIVA50.ESS0.5B.LN
- DIVA50.ESS0.5BB.LN
- DIVA50.ESS0.7.LN
- DIVA50.ESS0.11.LN
- DIVA50.ESS0.13.LN
- DIVA50.ESS0.14.LN
- DIVA50.ESS0.16.LN
- DIVA50.ESS0.30.LN

**build-in**

not compatible with adaption ring and torsion springs!  
nicht verwendbar mit Adapterring und Torsionfedern!

**PICO50.ESS0/./LN - Ø80 PUNCHED**

~230V  S2 IP20    0,1599  1 m  05.10.02 





downlight punched - round - fixed  
Einbaustrahler gestanz - rund - fest

**Lamptype**

 QPAR 51 GU10 (1) 50W 230V  
or  QPAR 51 GU10 (1) 11W 230V

**Dimensions**

 Ø89xH115  
 Ø80  135

**Options**

S6.80/.. - PLASTERKIT

**Ref cat (CAS)**

- PICO50.ESS0.1.LN
- PICO50.ESS0.1M.LN
- PICO50.ESS0.2.LN
- PICO50.ESS0.4.LN
- PICO50.ESS0.5.LN
- PICO50.ESS0.5B.LN
- PICO50.ESS0.5BB.LN
- PICO50.ESS0.7.LN
- PICO50.ESS0.11.LN
- PICO50.ESS0.13.LN
- PICO50.ESS0.14.LN
- PICO50.ESS0.16.LN
- PICO50.ESS0.30.LN

**build-in**

not compatible with adaption ring and torsion springs!  
nicht verwendbar mit Adapterring und Torsionfedern!

ARIA/.. - Ø80

~230V  S2 IP20   0,2206  1 m  05.10.02 





downlight - round - fixed  
Einbaustrahler - rund - fest

**Lamptype**

 QPAR 51 GU10 (1) 50W 230V  
or  QPAR 51 GU10 (1) 11W 230V

**Dimensions**

 Ø90xH90  
 Ø80  110

**Options**

S1/.. - TORSION SPRINGS  
S6.80/.. - PLASTERKIT

**Ref cat (CAS)**

ARIA.1  
ARIA.1M  
ARIA.2  
ARIA.4  
ARIA.5  
ARIA.5B  
ARIA.5BB  
ARIA.7  
ARIA.11  
ARIA.13  
ARIA.14  
ARIA.16  
ARIA.18  
ARIA.21  
ARIA.23  
ARIA.25  
ARIA.40

build-in

CAMBIO/.. - Ø80

~230V  S2 IP20    0,2642  1 m  05.10.02 





downlight - round - directional  
Einbaustrahler - rund - schwenkbar

**Lamptype**

 QPAR 51 GU10 (1) 50W 230V  
or  QPAR 51 GU10 (1) 11W 230V

**Dimensions**

 Ø90xH115  
 Ø80  135

**Options**

S1/.. - TORSION SPRINGS  
S6.80/.. - PLASTERKIT

**Ref cat (CAS)**

CAMBIO.1  
CAMBIO.1M  
CAMBIO.2  
CAMBIO.4  
CAMBIO.5  
CAMBIO.5B  
CAMBIO.5BB  
CAMBIO.7  
CAMBIO.11  
CAMBIO.13  
CAMBIO.14  
CAMBIO.16  
CAMBIO.18  
CAMBIO.21  
CAMBIO.23  
CAMBIO.25

build-in

SENSA/.. - Ø80

~230V



S2 IP20



0,3014



1 m



05.10.02



build-in



downlight - round - fixed  
Einbaustrahler - rund - fest

**Lamptype**

QPAR 51 GU10 (1) 50W 230V  
or QPAR 51 GU10 (1) 11W 230V

**Dimensions**

Ø90xH115  
Ø80 135

**Options**

S6.80/.. - PLASTERKIT

**Ref cat (CAS)**

- SENSA.1
- SENSA.1M
- SENSA.2
- SENSA.4
- SENSA.5
- SENSA.5B
- SENSA.5BB
- SENSA.7
- SENSA.11
- SENSA.13
- SENSA.14
- SENSA.16
- SENSA.18
- SENSA.25

FABO/.. - Ø80

~230V



S2 IP20



0,2077



0,5 m



05.10.02



build-in



downlight - round - fixed  
Einbaustrahler - rund - fest

**Lamptype**

QPAR 20 E27 (1) 50W 230V

**Dimensions**

Ø90xH125  
Ø80 145

**Options**

S6.80/.. - PLASTERKIT

**Ref cat (CAS)**

- FABO.1
- FABO.1M
- FABO.2
- FABO.4
- FABO.5B
- FABO.5BB
- FABO.7
- FABO.11
- FABO.13
- FABO.14
- FABO.16
- FABO.18
- FABO.25

VIDRIO/.. - Ø80

~230V  S2 IP20    0,2750  1 m  05.10.02 





downlight - round  
Einbaustrahler - rund

**Lamptype**

 mini lynx longlife E27 (1) 11W 230V

**Dimensions**

 Ø90xH130

 Ø80  75

**Options**

S6.80/.. - PLASTERKIT  
VIDRIOGLASS/.. - CONVERTIBLE SYSTEM

**Ref cat (CAS)**

VIDRIO.1  
VIDRIO.1M  
VIDRIO.2  
VIDRIO.4  
VIDRIO.7  
VIDRIO.11  
VIDRIO.13  
VIDRIO.14  
VIDRIO.16  
VIDRIO.18  
VIDRIO.25

build-in  
glass Ø50xH84  
Glas Ø50xH84

202/.. - Ø80 INOX 316

~230V  S1 IP20    0,2000  0,5 m  05.10.02 



downlight - round - fixed  
Einbaustrahler - rund - fest

**Lamptype**

 R63 E27 (1) 60W 230V

**Dimensions**

 Ø94xH120

 Ø80  140

**Options**

S6.80/.. - PLASTERKIT

**Ref cat (CAS)**

202.5  
202.5B  
202.5BB  
202.31  
202.32  
202.33

build-in

202.B/.. - Ø80 INOX 316

~230V  S1 IP20    0,4350  1 m  05.10.02 





downlight - round - fixed  
Einbaustrahler - rund - fest

**Lamptype**

 QPAR 20 E27 (1) 50W 230V

**Dimensions**

 Ø94xH120

 Ø80  140

**Options**

S6.80/.. - PLASTERKIT

**Ref cat (CAS)**

202.B.5  
202.B.5B  
202.B.5BB  
202.B.31  
202.B.32  
202.B.33

build-in

102H/.. - Ø80 INOX 316

~230V  S1 IP44    0,4350  0,5 m  05.10.02 



downlight - round - fixed  
Einbaustrahler - rund - fest

**Lamptype**

 R63 E27 (1) 60W 230V

**Dimensions**

 Ø94xH155

 Ø80  175

**Options**

S6.80/.. - PLASTERKIT

**Ref cat (CAS)**

102H.5  
102H.5B  
102H.5BB  
102H.31  
102H.32  
102H.33

build-in

**DIVA AR70/.. - Ø100**

~12V S2 IP20 0.5 05.10.02



downlight - directional - without transformer  
Einbaustrahler - schwenkbar - ohne Trafo

**Ref cat (01)**

- DIVA AR70.1M
- DIVA AR70.2M
- DIVA AR70.11M
- DIVA AR70.14

**Lamptype**

QR-LP70 BA15d (1) 50W 12V

**Dimensions**

Ø109xH80  
Ø100 √ 100

**Options**

- S1/.. - TORSION SPRINGS
- S6.100/.. - PLASTERKIT

build-in

**PICO AR70/.. - Ø100**

~12V S2 IP20 0.5 05.10.02



downlight - fixed - without transformer  
Einbaustrahler - fest - ohne Trafo

**Ref cat (01)**

- PICO AR70.1M
- PICO AR70.2M
- PICO AR70.11M
- PICO AR70.14

**Lamptype**

QR-LP70 BA15d (1) 50W 12V

**Dimensions**

Ø109xH80  
Ø100 √ 100

**Options**

- S1/.. - TORSION SPRINGS
- S6.100/.. - PLASTERKIT

build-in

**AQUAGR/.. - Ø100**

~12V S1 IP20 0,4600 0,5 m 05.10.02



downlight - round - fixed - without transformer  
Einbaustrahler - rund - fest - ohne Trafo

**Ref cat (CAS)**

- AQUAGR.1
- AQUAGR.7
- AQUAGR.11
- AQUAGR.14
- AQUAGR.16
- AQUAGR.18
- AQUAGR.25

**Lamptype**

QR-CB 51 GU5,3/GX5,3 (1) 50W 12V

**Dimensions**

Ø110xH100  
Ø100 √ 120

**Options**

- S6.100/.. - PLASTERKIT

build-in

**CUSCO/.. - 73x73**

~12V IP20 0,1600 0,5 m 05.10.02



downlight - square - without transformer  
Einbaustrahler - viereckig - ohne Trafo

**Ref cat (CAS)**

- CUSCO.1
- CUSCO.40

**Lamptype**

QT9-ax G4 (1) 20W 12V

**Dimensions**

L100xB100xH16,5  
73x73 √ 16,5

build-in  
Max. 20W

KUBO50/.. - Ø80

~12V S2 IP20 0,1939 0,5 m 05.10.02



downlight - square - fixed - second colour inside plate - without transformer  
Einbaustrahler - viereckig - fest - zweite Farbe der Innenplatte - ohne Trafo

**Lamp type**

QR-CB 51 GU5,3/GX5,3 (1) 50W 12V

**Dimensions**

L88xB88xH54

Ø80 74

**Options**

S6.80/.. - PLASTERKIT

**Ref cat (CAS)**

- KUBO50.1.1
- KUBO50.1.2
- KUBO50.1M.1M
- KUBO50.2.2
- KUBO50.4.2
- KUBO50.5.2
- KUBO50.5.5
- KUBO50.7.2
- KUBO50.7.7
- KUBO50.11.2
- KUBO50.11.5
- KUBO50.11.11
- KUBO50.11.14
- KUBO50.13.2
- KUBO50.14.2
- KUBO50.14.11
- KUBO50.14.14
- KUBO50.16.2
- KUBO50.16.14

build-in

KUBOGLAS50/.. - Ø80

~12V S2 IP20 0,2131 0,5 m 05.10.02



downlight - square - fixed - second color inside plate - with glass - without transformer  
Einbaustrahler - viereckig - fest - zweite Farbe der Innenplatte - mit Glass - ohne Trafo

**Lamp type**

QR-CB 51 GU5,3/GX5,3 (1) 50W 12V

**Dimensions**

L88xB88xH54

Ø80 74

**Options**

S6.80/.. - PLASTERKIT

**Ref cat (CAS)**

- KUBOGLAS50.1.1
- KUBOGLAS50.1M.1M
- KUBOGLAS50.2.2
- KUBOGLAS50.4.2
- KUBOGLAS50.5.2
- KUBOGLAS50.5.5
- KUBOGLAS50.7.2
- KUBOGLAS50.11.2
- KUBOGLAS50.11.11
- KUBOGLAS50.13.2
- KUBOGLAS50.14.2
- KUBOGLAS50.14.14
- KUBOGLAS50.16.2

build-in

**KUBO.ES50/.. - Ø80**

~230V    0,2380  1 m  05.10.02 



downlight - square - fixed - second colour inside plate  
Einbaustrahler - viereckig - fest - zweite Farbe der Innenplatte

**Lamptype**

 QPAR 51 GU10 (1) 50W 230V  
or  QPAR 51 GU10 (1) 11W 230V

**Dimensions**

 L88xB88xH97-105  
 Ø80  120

**Options**

S6.80/.. - PLASTERKIT

**Ref cat (CAS)**

- KUBO.ES50.1.1
- KUBO.ES50.1M.1M
- KUBO.ES50.2.2
- KUBO.ES50.4.2
- KUBO.ES50.5.5
- KUBO.ES50.7.2
- KUBO.ES50.11.11
- KUBO.ES50.13.2
- KUBO.ES50.14.14
- KUBO.ES50.16.2

build-in

**COCO50/.. - Ø80**

~12V   S2 IP20   0,1929  0,5 m  05.10.02 





downlight - square - fixed - second colour inside plate -  
without transformer  
Einbaustrahler - viereckig - fest - zweite Farbe der Innenplatte  
- ohne Trafo

**Lamptype**

 QR-CB 51 GU5,3/GX5,3 (1) 50W 12V

**Dimensions**

 L88xB88xH62  
 Ø80  82

**Options**

S6.80/.. - PLASTERKIT

**Ref cat (CAS)**

- COCO50.1.1
- COCO50.1M.1M
- COCO50.2.2
- COCO50.4.2
- COCO50.5.2
- COCO50.5.14
- COCO50.7.2
- COCO50.11.2
- COCO50.11.11
- COCO50.13.2
- COCO50.14.2
- COCO50.14.11
- COCO50.14.14
- COCO50.16.2

build-in



**COCO.E550/.. - Ø80**

~230V



downlight - square - fixed - second colour inside plate  
Einbaustrahler - viereckig - fest - zweite Farbe der Innenplatte

**Lamptype**

QPAR 51 GU10 (1) 50W 230V  
or QPAR 51 GU10 (1) 11W 230V

**Dimensions**

L88xB88xH97-105

Ø80 120

**Options**

S6.80/.. - PLASTERKIT

**Ref cat (CAS)**

COCO.E550.1.1  
COCO.E550.1M.1M  
COCO.E550.2.1  
COCO.E550.4.2  
COCO.E550.5.2  
COCO.E550.7.2  
COCO.E550.11.11  
COCO.E550.13.2  
COCO.E550.14.14  
COCO.E550.16.2

build-in

**GALA/.. - Ø80**

~12V



square - fixed - without transformer  
viereckig - fest - ohne Trafo

**Lamptype**

QR-CB 51 GU5,3/GX5,3 (1) 50W 12V

**Dimensions**

L88xB88xH54

Ø80 74

**Options**

S6.80/.. - PLASTERKIT

**Ref cat (CAS)**

GALA.1  
GALA.1M  
GALA.2  
GALA.4  
GALA.5  
GALA.7  
GALA.11  
GALA.13  
GALA.14  
GALA.16

build-in

**BORA50/.. - Ø80 - M10**



build-in base for spotlight or pendant - square - second colour inside plate - without transformer  
Einbaubasis für Aufbaustrahler oder Pendelleuchte - viereckig - zweite Farbe der Innenplatte - ohne Trafo

**Dimensions**

L88xB88xH42

Ø80 42

**Options**

S6.80/.. - PLASTERKIT

**Ref cat (BAS)**

BORA50.1.1  
BORA50.2.2  
BORA50.4.2  
BORA50.5.5  
BORA50.5.14  
BORA50.5.14  
BORA50.7.2  
BORA50.11.2  
BORA50.13.2  
BORA50.14.2  
BORA50.14.14  
BORA50.16.2  
BORA50.16.16

build-in

**QUAD/.. - Ø86**

~12V

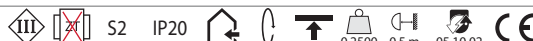

downlight - square - directional - without transformer  
Einbaustrahler - viereckig - schwenkbar - ohne Trafo

**Lamptype**

QR-CB 51 GU5,3/GX5,3 (1) 50W 12V

**Dimensions**

L100xB100xH65

Ø86 85

**Options**

S6.90/.. - PLASTERKIT

**Ref cat (CAS)**

QUAD.5

build-in



859/.. - ZOOM

~12V S1 IP20 0,2216 0,5 m 05.10.02



downlight - without transformer  
Einbaustrahler - ohne Trafo

Ref cat (04)

Lamp type

QR-CB 51 GU5,3/GX5,3 (1) 50W 12V

Dimensions

L89,5xB89,5xH55

72x72 75

859.1  
859.4  
859.7  
859.16  
859.40

build-in

FOX.FIX.ES50/.. - 70x70

~230V S1 IP20 0,2620 1 m 05.10.02



downlight - square - fixed  
Einbaustrahler - viereckig - fest

Ref cat (CAS)

Lamp type

QPAR 51 GU10 (1) 50W 230V  
or QPAR 51 GU10 (1) 11W 230V

Dimensions

L80xB80xH105-120

70x70 125

Options

S9.70/.. - PLASTERKIT

FOX.FIX.ES50.1.1  
FOX.FIX.ES50.1.14  
FOX.FIX.ES50.1M.1M  
FOX.FIX.ES50.2.2  
FOX.FIX.ES50.4.2  
FOX.FIX.ES50.5.11  
FOX.FIX.ES50.7.11  
FOX.FIX.ES50.11.11  
FOX.FIX.ES50.13.2  
FOX.FIX.ES50.16.2

build-in

FOX.FIX/.. - 70x70

~12V S1 IP20 0,2273 0,5 m 05.10.02



downlight - square - fixed - without transformer  
Einbaustrahler - viereckig - fest - ohne Trafo

Ref cat (CAS)

Lamp type

QR-CB 51 GU5,3/GX5,3 (1) 50W 12V

Dimensions

L80xB80xH95-110

70x70 115

Options

S9.70/.. - PLASTERKIT

FOX.FIX.1.1  
FOX.FIX.1.2  
FOX.FIX.1.14  
FOX.FIX.1M.1M  
FOX.FIX.2.2  
FOX.FIX.4.2  
FOX.FIX.5.11  
FOX.FIX.7.11  
FOX.FIX.11.11  
FOX.FIX.13.2  
FOX.FIX.16.2

build-in

FOX.DIR.ES50/.. - 70x70

~230V S1 IP20 0,2467 1 m 05.10.02



downlight - square - directional  
Einbaustrahler - viereckig - schwenkbar

Ref cat (CAS)

Lamp type

QPAR 51 GU10 (1) 50W 230V  
or QPAR 51 GU10 (1) 11W 230V

Dimensions

L80xB80xH95-115

70x70 125

Options

S9.70/.. - PLASTERKIT

FOX.DIR.ES50.1.1  
FOX.DIR.ES50.1M.1M  
FOX.DIR.ES50.2.2  
FOX.DIR.ES50.4.2  
FOX.DIR.ES50.5.11  
FOX.DIR.ES50.7.11  
FOX.DIR.ES50.11.11  
FOX.DIR.ES50.13.2  
FOX.DIR.ES50.16.2

build-in

## INDOOR | Downlights | 70x70 | Ø80 SYSTEM

FOX.DIR/.. - 70x70

~12V



S1

IP20



downlight - square - directional - without transformer  
Einbaustrahler - viereckig - schwenkbar - ohne Trafo

### Lamp type

QR-CB 51 GU5,3/GX5,3 (1) 50W 12V

### Dimensions

L80xB80xH85-105

70x70 115

### Options

S9.70/.. - PLASTERKIT

### Ref cat (CAS)

FOX.DIR.1.1  
FOX.DIR.1.2  
FOX.DIR.1M.1M  
FOX.DIR.2.2  
FOX.DIR.4.2  
FOX.DIR.5.11  
FOX.DIR.7.11  
FOX.DIR.7.11  
FOX.DIR.11.11  
FOX.DIR.13.2  
FOX.DIR.16.2

build-in

## Ø 80 SYSTEM

### BASES

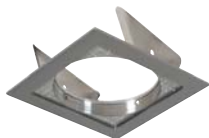

frame80

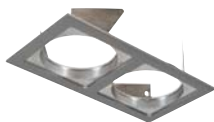

frame2x80

### CASSETTES



casvario50  
casvario.ES50



cashero50  
cashero.ES50



casdeco50

spot of pendel afzonderlijk te bestellen  
spot ou suspension à commander séparément  
spot or pendant to order separately  
Spot oder Pendelleuchte separat bestellen

## FRAME80/.. - Ø80 SYSTEM

S2 IP20



build-in base for cassette - square  
Einbaubasis für Kassette - viereckig

### Dimensions

L100xB100xH30

Ø80

### Options

CASDECO50/.. - Ø80 SYSTEM

CASHERO50 - ES50

CASVARIO50 - ES50

S6.80/.. - PLASTERKIT

### Ref cat (BAS)

FRAME80.1  
FRAME80.1M  
FRAME80.2  
FRAME80.11  
FRAME80.14

build-in

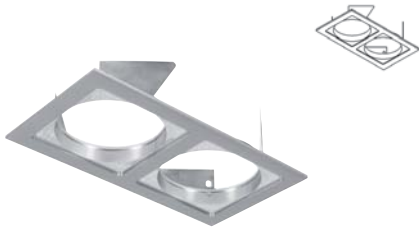

**FRAME2X80/.. - 2xØ80 SYSTEM**

S2 IP20    0.1300 



build-in base for cassette - square  
Einbaubasis für Kassette - viereckig

**Dimensions**

↔ L190xB100xH30  
 2xØ80  [88]

**Options**

CASDECO50/.. - Ø80 SYSTEM  
CASHERO50 - ES50  
CASVARIO50 - ES50  
S7.80/.. - PLASTERKIT

**Ref cat (BAS)**

FRAME2X80.1  
FRAME2X80.1M  
FRAME2X80.2  
FRAME2X80.11  
FRAME2X80.14

**CASVARIO50/.. - Ø80 SYSTEM**

~12V   IP20     0,0900  0,5 m  05.10.02 



build-in cassette - directional - without transformer  
Einbaukassette - schwenkbar - ohne Trafo

**Lamptype**

 QR-CB 51 GU5,3/GX5,3 (1) 50W 12V

**Dimensions**

↔ H70

**Ref cat (CAS)**

CASVARIO50.1  
CASVARIO50.1M  
CASVARIO50.2  
CASVARIO50.11  
CASVARIO50.14

**CASVARIO.ES50/.. - Ø80 SYSTEM**

~230V  IP20     0,1000  1 m  05.10.02 



build-in cassette - directional  
Einbaukassette - schwenkbar

**Lamptype**

 QPAR 51 GU10 (1) 50W 230V  
or  QPAR 51 GU10 (1) 11W 230V

**Dimensions**

↔ H110

**Ref cat (CAS)**

CASVARIO.ES50.1  
CASVARIO.ES50.1M  
CASVARIO.ES50.2  
CASVARIO.ES50.11  
CASVARIO.ES50.14

**CASHERO50/.. - Ø80 SYSTEM**

~12V   IP20    0,1000  0,5 m  05.10.02 



build-in cassette - fixed - without transformer  
Einbaukassette - fest - ohne Trafo

**Lamptype**

 QR-CB 51 GU5,3/GX5,3 (1) 50W 12V

**Dimensions**

↔ H70

**Ref cat (CAS)**

CASHERO50.1  
CASHERO50.1M  
CASHERO50.2  
CASHERO50.11  
CASHERO50.14

CASHERO.ES50/.. - Ø80 SYSTEM

~230V



build-in cassette - fixed  
Einbaukassette - fest

Lamptype

QPAR 51 GU10 (1) 50W 230V  
or QPAR 51 GU10 (1) 11W 230V

Dimensions

H110

Ref cat (CAS)

CASHERO.ES50.1  
CASHERO.ES50.1M  
CASHERO.ES50.2  
CASHERO.ES50.11  
CASHERO.ES50.14

CASDECO50/.. - Ø80 SYSTEM - M10



build-in cassette for spotlight or pendant  
Einbaukassette für Aufbaustrahler oder Pendelleuchte

Dimensions

H25

Ref cat (BAS)

CASDECO50.1  
CASDECO50.1M  
CASDECO50.2  
CASDECO50.11  
CASDECO50.14

VARIO50/.. - Ø80

~12V



downlight - square - directional - without transformer  
Einbaustrahler - viereckig - schwenkbar - ohne Trafo

Lamptype

QR-CB 51 GU5,3/GX5,3 (1) 50W 12V

Dimensions

L100xB100xH70

Ø80 90

Options

S6.80/.. - PLASTERKIT

Ref cat (CAS)

VARIO50.1  
VARIO50.1M  
VARIO50.2  
VARIO50.11  
VARIO50.14

build-in

VARIO.ES50/.. - Ø80

~230V



downlight - square - directional  
Einbaustrahler - viereckig - schwenkbar

Lamptype

QPAR 51 GU10 (1) 50W 230V  
or QPAR 51 GU10 (1) 11W 230V

Dimensions

L100xB100xH110

Ø80 130

Options

S6.80/.. - PLASTERKIT

Ref cat (CAS)

VARIO.ES50.1  
VARIO.ES50.1M  
VARIO.ES50.2  
VARIO.ES50.11  
VARIO.ES50.14

build-in

**HERO50/.. - Ø80**

~12V S2 IP20 0,1600 0,5 m 05.10.02



downlight - square - fixed - without transformer  
Einbaustrahler - viereckig - fest - ohne Trafo

**Ref cat (CAS)**

**Lamptype**

QR-CB 51 GU5,3/GX5,3 (1) 50W 12V

- HERO50.1
- HERO50.1M
- HERO50.2
- HERO50.11
- HERO50.14

**Dimensions**

L100xB100xH70

Ø80 H 70

**Options**

S6.80/.. - PLASTERKIT

build-in

**HERO.ES50/.. - Ø80**

~230V S2 IP20 0,2100 1 m 05.10.02



downlight - square - fixed  
Einbaustrahler - viereckig - fest

**Ref cat (CAS)**

**Lamptype**

QPAR 51 GU10 (1) 50W 230V  
or QPAR 51 GU10 (1) 11W 230V

- HERO.ES50.1
- HERO.ES50.1M
- HERO.ES50.2
- HERO.ES50.11
- HERO.ES50.14

**Dimensions**

L100xB100xH110

Ø80 H 130

**Options**

S6.80/.. - PLASTERKIT

build-in

**DECO50/.. - Ø80 - M10**

S2 IP20 0,1200



build-in base for spotlight or pendant - square  
Einbaubasis für Aufbaustrahler oder Pendelleuchte - viereckig

**Ref cat (BAS)**

**Dimensions**

L100xB100xH33

Ø80 H 40

- DECO50.1
- DECO50.1M
- DECO50.2
- DECO50.11
- DECO50.14

**Options**

S6.80/.. - PLASTERKIT

build-in

## INDOOR | Downlights | KOZA Ø80

also available without clamp  
auch verfügbar ohne Bügel

### 1474.DICRO/./S1 - KOZA

~12V



downlight - round - fixed - without transformer  
Einbaustrahler - rund - fest - ohne Trafo

#### Lamptype

QR-CB 51 GU5,3/GX5,3 (1) 50W 12V

#### Dimensions

Ø87xH120

Ø80 140

#### Options

S6.80/.. - PLASTERKIT

#### Ref cat (CAS)

1474.DICRO.1M.S1

1474.DICRO.7.S1

1474.DICRO.11.S1

1474.DICRO.14.S1

build-in

### 1474.DICRO/./S2 - KOZA

~12V



downlight - round - fixed - without transformer  
Einbaustrahler - rund - fest - ohne Trafo

#### Lamptype

QR-CB 51 GU5,3/GX5,3 (1) 50W 12V

#### Dimensions

Ø87xH120

Ø80 140

#### Options

S6.80/.. - PLASTERKIT

#### Ref cat (CAS)

1474.DICRO.1M.S2

1474.DICRO.7.S2

1474.DICRO.11.S2

1474.DICRO.14.S2

build-in

### 1474.ES50/./S1 - KOZA

~230V



downlight - round - fixed  
Einbaustrahler - rund - fest

#### Lamptype

QPAR 51 GU10 (1) 35W 230V

#### Dimensions

Ø87xH135

Ø80 155

#### Options

S6.80/.. - PLASTERKIT

#### Ref cat (CAS)

1474.ES50.1M.S1

1474.ES50.7.S1

1474.ES50.11.S1

1474.ES50.14.S1

build-in

### 1474.ES50/./S2 - KOZA

~230V



downlight - round - fixed  
Einbaustrahler - rund - fest

#### Lamptype

QPAR 51 GU10 (1) 35W 230V

#### Dimensions

Ø87xH135

Ø80 155

#### Options

S6.80/.. - PLASTERKIT

#### Ref cat (CAS)

1474.ES50.1M.S2

1474.ES50.7.S2

1474.ES50.11.S2

1474.ES50.14.S2

build-in

also available without clamp  
auch verfügbar ohne Bügel

1474.MEGA/..S1 - KOZA

~230V  S1 IP20   0,0513 1 m 05.10.02 



downlight - round - fixed  
Einbaustrahler - rund - fest

**Lamptype**

 QPAR 51 GU10 (1) 11W 230V

**Dimensions**

 Ø87xH135

 Ø80  155

**Options**

S6.80/.. - PLASTERKIT

**Ref cat (CAS)**

1474.MEGA.1M.S1  
1474.MEGA.7.S1  
1474.MEGA.11.S1  
1474.MEGA.14.S1

build-in

1474.MEGA/..S2 - KOZA

~230V  S2 IP20   0,0513 1 m 05.10.02 



downlight - round - fixed  
Einbaustrahler - rund - fest

**Lamptype**

 QPAR 51 GU10 (1) 11W 230V

**Dimensions**

 Ø87xH135

 Ø80  155

**Options**

S6.80/.. - PLASTERKIT

**Ref cat (CAS)**

1474.MEGA.1M.S2  
1474.MEGA.7.S2  
1474.MEGA.11.S2  
1474.MEGA.14.S2

build-in

1479.DICRO/..S1 - KOZA

~12V   S1 IP20   0,0400 0,5 m 05.10.02 



downlight - round - directional - without transformer  
Einbaustrahler - rund - schwenkbar - ohne Trafo

**Lamptype**

 QR-CB 51 GU5,3/GX5,3 (1) 50W 12V

**Dimensions**

 Ø87xH120

 Ø80  140

**Options**

S6.80/.. - PLASTERKIT

**Ref cat (CAS)**

1479.DICRO.1M.S1  
1479.DICRO.7.S1  
1479.DICRO.11.S1  
1479.DICRO.14.S1

build-in

1479.DICRO/..S2 - KOZA

~12V   S2 IP20   0,0550 0,5 m 05.10.02 



downlight - round - directional - without transformer  
Einbaustrahler - rund - schwenkbar - ohne Trafo

**Lamptype**

 QR-CB 51 GU5,3/GX5,3 (1) 50W 12V

**Dimensions**

 Ø87xH120

 Ø80  140

**Options**

S6.80/.. - PLASTERKIT

**Ref cat (CAS)**

1479.DICRO.1M.S2  
1479.DICRO.7.S2  
1479.DICRO.11.S2  
1479.DICRO.14.S2

build-in

## INDOOR | Downlights | KOZA Ø80

also available without clamp  
auch verfügbar ohne Bügel

### 1479.ES50/.../S1 - KOZA

~230V  S1 IP20     0.5 m  05.10.02 





downlight - round - directional  
Einbaustrahler - rund - schwenkbar

#### Lamp type

 QPAR 51 GU10 (1) 35W 230V

#### Dimensions

 Ø87xH135  
 Ø80  155

#### Options

S6.80/... - PLASTERKIT

#### Ref cat (CAS)

1479.ES50.1M.S1  
1479.ES50.7.S1  
1479.ES50.11.S1  
1479.ES50.14.S1

build-in

### 1479.ES50/.../S2 - KOZA

~230V  S2 IP20     0,0600 0.5 m  05.10.02 





downlight - round - directional  
Einbaustrahler - rund - schwenkbar

#### Lamp type

 QPAR 51 GU10 (1) 35W 230V

#### Dimensions

 Ø87xH135  
 Ø80  155

#### Options

S6.80/... - PLASTERKIT

#### Ref cat (CAS)

1479.ES50.1M.S2  
1479.ES50.7.S2  
1479.ES50.11.S2  
1479.ES50.14.S2

build-in

### 1479.MEGA/.../S1 - KOZA

~230V  S1 IP20     0.5 m  05.10.02 





downlight - round - directional  
Einbaustrahler - rund - schwenkbar

#### Lamp type

 QPAR 51 GU10 (1) 11W 230V

#### Dimensions

 Ø87xH135  
 Ø80  155

#### Options

S6.80/... - PLASTERKIT

#### Ref cat (CAS)

1479.MEGA.1M.S1  
1479.MEGA.7.S1  
1479.MEGA.11.S1  
1479.MEGA.14.S1

build-in

### 1479.MEGA/.../S2 - KOZA

~230V  S2 IP20     0.5 m  05.10.02 





downlight - round - directional  
Einbaustrahler - rund - schwenkbar

#### Lamp type

 QPAR 51 GU10 (1) 11W 230V

#### Dimensions

 Ø87xH135  
 Ø80  155

#### Options

S6.80/... - PLASTERKIT

#### Ref cat (CAS)

1479.MEGA.1M.S2  
1479.MEGA.7.S2  
1479.MEGA.11.S2  
1479.MEGA.14.S2

build-in



NL

Binnen het gamma van onze kwalitatief hoogstaande inbouwspots is er met het **“Convertible System”** de mogelijkheid om met **1 inbouwdiameter van 80 mm** bijna onbeperkt te combineren.

De basis hierbij is een vaste afdekplaat.

Bij de enkelvoudige basissen is er de keuze tussen roundbase (ronde afdekplaat) en singlebase (vierkante afdekplaat).

Wanneer u twee inbouwcassettes in 1 plaat wilt vastzetten, kiest u voor de rechthoekige twinbase.

Met de triplebase zijn dat er drie.

Het binnenste, de “cassette”, kan men vervangen en zodoende in één oogwenk het toestel van bv. vast naar richtbaar, downlight of half opbouw -half inbouw of zelfs pendel omschakelen.

Omdat er met dit systeem ongeveer 20 armaturen in een 12-tal standaardkleuren naar eigen smaak en creativiteit gecombineerd kunnen worden, kunnen we zelfs de meest veeleisende klanten tevreden stellen.

FR

PSM est renommé pour l'emploi de matériaux de qualité supérieure comme l'inox, le laiton et l'aluminium. Parmi les spots encastrés hauts de gamme, on trouve aussi le **“Convertible System”**.

Ce système donne au client la possibilité de faire des combinaisons presque infinies avec **un seul diamètre d'encastrement de 80 mm**. L'anneau extérieur est la base dans laquelle on peut clipser une cassette. On a des bases rondes (roundbase) et carrées (singlebase) pour y mettre une cassette et des bases rectangulaires qui peuvent tenir deux (twinbase) ou trois (triplebase) cassettes. Cette cassette (= l'intérieur du spot) peut être remplacée.

De cette manière on peut changer le spot de fixe à orientable, downlight, semi-apparent ... en un clin d'œil. Par cette interchangeabilité entre environ 20 armatures et plus au moins 12 coloris standards différents, on a la possibilité de satisfaire aux vœux des clients les plus exigeants.

EN

Within the PSM Lighting product range, the **Convertible System** with a **single cut-out diameter of 80 mm** offers the possibility to create different types of luminaires, using only one base.

The outside ring is the base. There is a choice of 4 different types of bases. We offer a round one (roundbase) and a square one (singlebase) for one cassette. A twinbase can hold 2 cassettes and using a triplebase, you can click in three. The inside of the luminaire, the cassette, is interchangeable.

Using this system, a fixed downlight can be changed into a directional one, a semi built-in, semi built-up, wallwasher or even a pendant within a blink of an eye.

We offer a choice of 20 luminaires available in approximately 12 standard colours. This kind of flexibility is the answer to our customers' growing need to be creative and adds a personal touch to ones lighting.

DE

Mit dem **Convertible System** von PSM Lighting gibt es die Möglichkeit mit **einem Einbaudurchmesser von 80mm** fast jede beliebige Leuchtenkombination zu realisieren.

Die sichtbare, äußere Abdeckplatte ist hier die Ausgangsbasis: man kann diese sowohl rund (roundbase) als auch viereckig (singlebase) bekommen.

Es ist auch möglich, Abdeckplatten in zweifacher Ausführung (twinbase) als auch in dreifacher Ausführung zu erhalten (triplebase).

Der innere Teil der Leuchte, die sog. Kassette, ist austauschbar. Auf diese Weise ist es möglich, aus einer festen, festen Einbauleuchte einen schwenkbaren Einbaustrahler zu machen. Es ist ebenfalls möglich, aus einem festen Downlight eine Halb-Aufbauleuchte zu bauen oder auch komplett in einer Pendelleuchte umzutauschen. Mit diesem kompatiblen Beleuchtungssystem ist es möglich, 20 unterschiedliche Leuchten mit 12 Standardfarben zu kombinieren. Dank dieser Art von Flexibilität haben wir die Möglichkeit, dem anspruchsvollen Kunden eine kreative, persönliche und für ihn angepasste Beleuchtungslösung anzubieten.



## CONVERTIBLE SYSTEM Ø 80

### BASES



roundbaseUSA  
Ø 75-76



roundbase  
Ø 80



roundbase.D100  
Ø 80



twobase



kox 1760/..



singlebase Ø 80



twinbase



triplebase

### CASSETTES



caspicoc 12V



casdownc 12V



casdivac 12V



casdivadownc 12V



cassirac 12V



casversoc 12V



caswallc 12V



cascanoc 12V



casformc 12V



casturnerc12V



casariac 230V



casaquanodotc 12V



castitusc 12V



casvidrioc 12V



castarga 12V



cassaxoc 12V/230V



cascambioc 230V



cascambiodownc  
230V



caspolka.AR70  
DICRO 12V



caspolka.ES50 - ES63  
230V

**example**  
cassaxoc  
+jupiter



**example**  
caszenoc  
+step



caszenoc 12V - 230V



caszeno.B3.c  
12V - 230V



enkel voor pendel  
seulement pour suspension  
only for pendant  
nur für Pendelleuchte



spot of pendel afzonderlijk te bestellen | spot ou suspension à commander séparément  
spot or pendant to order separately | Spot oder Pendelleuchte separat bestellen

**ROUNDBASE/.. - standard Ø80 CONVERTIBLE SYSTEM**

S2 IP20    0,0963 



build-in base for cassette - round  
Einbaubasis für Kassette - rund

**Dimensions**

↔ Ø89xH30

 Ø80  33

**Options**

S6.80/.. - PLASTERKIT

**Ref cat (BAS)**

- ROUNDBASE.1
- ROUNDBASE.1M
- ROUNDBASE.1S
- ROUNDBASE.2
- ROUNDBASE.4
- ROUNDBASE.5
- ROUNDBASE.5B
- ROUNDBASE.5BB
- ROUNDBASE.7
- ROUNDBASE.11
- ROUNDBASE.11S
- ROUNDBASE.13
- ROUNDBASE.14
- ROUNDBASE.16
- ROUNDBASE.18
- ROUNDBASE.21
- ROUNDBASE.23
- ROUNDBASE.25
- ROUNDBASE.40

build-in

**ROUNDBASEUSA/.. - special Ø75-76 CONVERTIBLE SYSTEM**

S2 IP20    0,0660 



build-in base for cassette - round  
Einbaubasis für Kassette - rund

**Dimensions**

↔ Ø89xH30

 Ø75-76  33

**Options**

S6.80/.. - PLASTERKIT

**Ref cat (BAS)**

- ROUNDBASEUSA.1
- ROUNDBASEUSA.1M
- ROUNDBASEUSA.2
- ROUNDBASEUSA.4
- ROUNDBASEUSA.7
- ROUNDBASEUSA.13
- ROUNDBASEUSA.14
- ROUNDBASEUSA.16
- ROUNDBASEUSA.21
- ROUNDBASEUSA.23

build-in

**ROUNDBASE.D100/.. - special 100 CONVERTIBLE SYSTEM**



S2 IP20    0,0864 



build-in base for cassette - round  
Einbaubasis für Kassette - rund

**Dimensions**

↔ Ø100xH30

 Ø80  33

**Options**

S6.80/.. - PLASTERKIT

**Ref cat (BAS)**

- ROUNDBASE.D100.1
- ROUNDBASE.D100.1M
- ROUNDBASE.D100.2
- ROUNDBASE.D100.4
- ROUNDBASE.D100.7
- ROUNDBASE.D100.11
- ROUNDBASE.D100.13
- ROUNDBASE.D100.14
- ROUNDBASE.D100.16
- ROUNDBASE.D100.21
- ROUNDBASE.D100.23

build-in

S5/.. - TERMINAL BLOCK CONVERTIBLE SYSTEM

IP20   0,0200 



accessory for downlight - strain relief terminal  
Zubehör für Einbaustrahler - Anschlußklemme mit  
Zugentlastung

**Dimensions**

↔ H75

**Ref cat (XX)**

S5

only for roundbase  
Nur für Roundbase

SINGLEBASE/.. - Ø80

S2 IP20    0,1189 



build-in base for cassette - square  
Einbaubasis für Kassette - viereckig

**Dimensions**

↔ L100xB100xH30

 Ø80  33

**Options**

S1/.. - TORSION SPRINGS

S6.80/.. - PLASTERKIT

**Ref cat (BAS)**

- SINGLEBASE.1
- SINGLEBASE.1M
- SINGLEBASE.1S
- SINGLEBASE.2
- SINGLEBASE.4
- SINGLEBASE.5
- SINGLEBASE.5B
- SINGLEBASE.5BB
- SINGLEBASE.7
- SINGLEBASE.11
- SINGLEBASE.11S
- SINGLEBASE.13
- SINGLEBASE.14
- SINGLEBASE.16
- SINGLEBASE.18
- SINGLEBASE.21
- SINGLEBASE.23
- SINGLEBASE.25
- SINGLEBASE.40

build-in



**TWINBASE/.. - 2xØ80 CONVERTIBLE SYSTEM**

S1 IP20    0,2040 



build-in base for 2 cassettes - square  
Einbaubasis für 2 Kassetten - viereckig

**Dimensions**

↔ L180xB100xH30

 2xØ80  33  [85]

**Options**

S2/.. - FLAT SPRINGS

S7.80/.. - PLASTERKIT

**Ref cat (BAS)**

- TWINBASE.1
- TWINBASE.1M
- TWINBASE.1S
- TWINBASE.2
- TWINBASE.4
- TWINBASE.5
- TWINBASE.5B
- TWINBASE.5BB
- TWINBASE.7
- TWINBASE.11
- TWINBASE.11S
- TWINBASE.13
- TWINBASE.14
- TWINBASE.16
- TWINBASE.18
- TWINBASE.21
- TWINBASE.23
- TWINBASE.25
- TWINBASE.40

build-in

**TWOBASE/.. - 2xØ80 CONVERTIBLE SYSTEM**

S1 IP20    0,0058 



build-in base for 2 cassettes - oval  
Einbaubasis für 2 Kassetten - oval

**Dimensions**

↔ L180xB100xH30

 2xØ80  33  [85]

**Options**

S2/.. - FLAT SPRINGS

S7.80/.. - PLASTERKIT

**Ref cat (BAS)**

- TWOBASE.1
- TWOBASE.1M
- TWOBASE.1S
- TWOBASE.2
- TWOBASE.4
- TWOBASE.5
- TWOBASE.5B
- TWOBASE.5BB
- TWOBASE.7
- TWOBASE.11
- TWOBASE.11S
- TWOBASE.13
- TWOBASE.14
- TWOBASE.16
- TWOBASE.18
- TWOBASE.21
- TWOBASE.23
- TWOBASE.25
- TWOBASE.40

build-in

**TRIPLEBASE/.. - 3xØ80 CONVERTIBLE SYSTEM**

S1 IP20    0.2757 



build-in base for 3 cassettes - square  
Einbaubasis für 3 Kassetten - viereckig

**Dimensions**

↔ L270xB100xH30  
 3xØ80  33  [85][85]

**Options**

S2/.. - FLAT SPRINGS  
 S8.80/.. - PLASTERKIT

**Ref cat (BAS)**

- TRIPLEBASE.1
- TRIPLEBASE.1M
- TRIPLEBASE.2
- TRIPLEBASE.4
- TRIPLEBASE.7
- TRIPLEBASE.11
- TRIPLEBASE.13
- TRIPLEBASE.14
- TRIPLEBASE.16
- TRIPLEBASE.18
- TRIPLEBASE.21
- TRIPLEBASE.23
- TRIPLEBASE.25
- TRIPLEBASE.40

build-in

**1760/.. - KOX CONVERTIBLE SYSTEM**

~230V  IP20    0.2761  0.5 m 



ceiling light for downlight Convertible System - to be ordered separately  
 Deckenleuchte für Einbaustrahler Convertible System - separat zu bestellen

**Dimensions**

↔ Ø100xH110

**Ref cat (04)**

- 1760.1M
- 1760.2M
- 1760.11M
- 1760.14
- 1760.21

build-up  
 no room for transformer  
 kein Platz für Trafo!

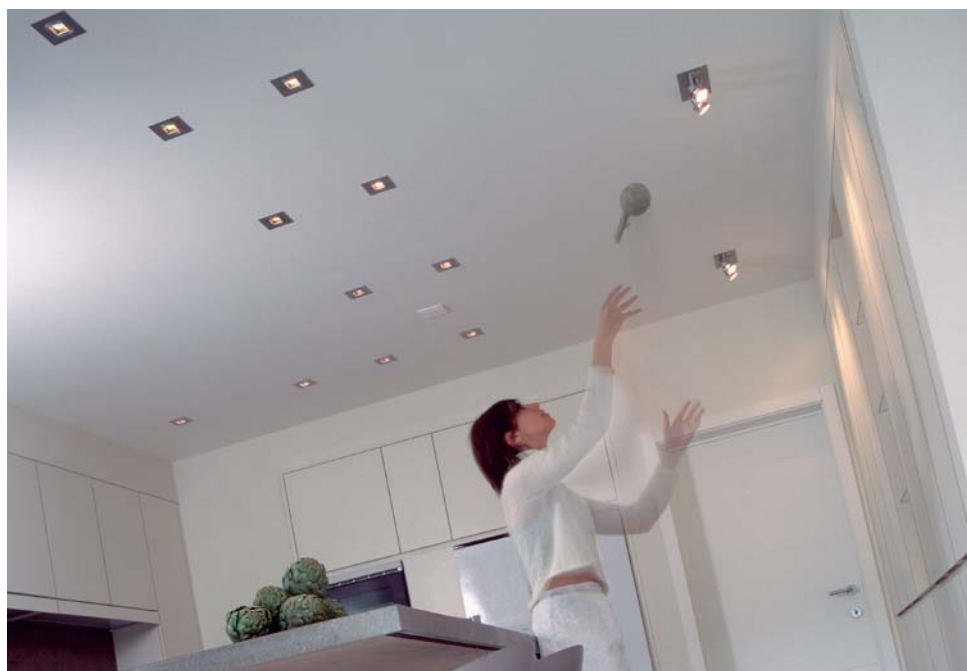

CASPICOC/.. - CONVERTIBLE SYSTEM

~12V



build-in cassette - fixed - without transformer  
Einbaukassette - fest - ohne Trafo

**Lamptype**

◁ QR-CB 51 GU5,3/GX5,3 (1) 50W 12V

**Dimensions**

↔ H55

**Ref cat (CAS)**

- CASPICOC.1
- CASPICOC.1M
- CASPICOC.1S
- CASPICOC.2
- CASPICOC.4
- CASPICOC.5
- CASPICOC.5B
- CASPICOC.5BB
- CASPICOC.7
- CASPICOC.11
- CASPICOC.11S
- CASPICOC.13
- CASPICOC.14
- CASPICOC.16
- CASPICOC.18
- CASPICOC.21
- CASPICOC.23
- CASPICOC.25
- CASPICOC.40

CASPDOWNC/.. - CONVERTIBLE SYSTEM

~12V



build-in cassette - fixed - without transformer  
Einbaukassette - fest - ohne Trafo

**Lamptype**

◁ QR-CB 51 GU5,3/GX5,3 (1) 50W 12V

**Dimensions**

↔ H70

**Ref cat (CAS)**

- CASPDOWNC.1
- CASPDOWNC.1M
- CASPDOWNC.2
- CASPDOWNC.4
- CASPDOWNC.5
- CASPDOWNC.7
- CASPDOWNC.11
- CASPDOWNC.13
- CASPDOWNC.14
- CASPDOWNC.16
- CASPDOWNC.18
- CASPDOWNC.21
- CASPDOWNC.25
- CASPDOWNC.40

CASDIVAC/.. - CONVERTIBLE SYSTEM

~12V



build-in cassette - directional - without transformer  
Einbaukassette - schwenkbar - ohne Trafo

**Lamptype**

QR-CB 51 GU5,3/GX5,3 (1) 50W 12V

**Dimensions**

H62

**Ref cat (CAS)**

- CASDIVAC.1
- CASDIVAC.1M
- CASDIVAC.2
- CASDIVAC.4
- CASDIVAC.5
- CASDIVAC.5B
- CASDIVAC.5BB
- CASDIVAC.7
- CASDIVAC.11
- CASDIVAC.11S
- CASDIVAC.13
- CASDIVAC.14
- CASDIVAC.16
- CASDIVAC.18
- CASDIVAC.21
- CASDIVAC.23
- CASDIVAC.25
- CASDIVAC.40

CASDIVADOWNC/.. - CONVERTIBLE SYSTEM

~12V



build-in cassette - directional - without transformer  
Einbaukassette - schwenkbar - ohne Trafo

**Lamptype**

QR-CB 51 GU5,3/GX5,3 (1) 50W 12V

**Dimensions**

H70

**Ref cat (CAS)**

- CASDIVADOWNC.1
- CASDIVADOWNC.1M
- CASDIVADOWNC.2
- CASDIVADOWNC.4
- CASDIVADOWNC.7
- CASDIVADOWNC.11
- CASDIVADOWNC.11S
- CASDIVADOWNC.13
- CASDIVADOWNC.14
- CASDIVADOWNC.16
- CASDIVADOWNC.21
- CASDIVADOWNC.23
- CASDIVADOWNC.40

**build-in**  
with recessed light source  
mit versenkte Lichtquelle



**CASSIRAC/.. - CONVERTIBLE SYSTEM**

~12V



build-in cassette - fixed - without transformer  
Einbaukassette - fest - ohne Trafo

**Ref cat (CAS)**

- CASSIRAC.7
- CASSIRAC.14

**Lamp type**

QR-CB 51 GU5,3/GX5,3 (1) 50W 12V

**Dimensions**

H80

**CASCANOC/.. - CONVERTIBLE SYSTEM**

~12V



build-in cassette - fixed - without transformer  
Einbaukassette - fest - ohne Trafo

**Ref cat (CAS)**

- CASCANOC.1
- CASCANOC.1M
- CASCANOC.2
- CASCANOC.4
- CASCANOC.7
- CASCANOC.11
- CASCANOC.13
- CASCANOC.14
- CASCANOC.16
- CASCANOC.18
- CASCANOC.21
- CASCANOC.23

**Lamp type**

QR-CB 51 coolfit GU5,3/GX5,3 (1) 35W 12V

**Dimensions**

H33

semi build in/up  
use coolfit lamp  
Coolfit-Lampe verwenden

**CASWALLC/.. - CONVERTIBLE SYSTEM**

~12V



build-in cassette - fixed - without transformer  
Einbaukassette - fest - ohne Trafo

**Ref cat (CAS)**

- CASWALLC.1
- CASWALLC.1M
- CASWALLC.2
- CASWALLC.4
- CASWALLC.5
- CASWALLC.5B
- CASWALLC.7
- CASWALLC.11
- CASWALLC.13
- CASWALLC.14
- CASWALLC.16
- CASWALLC.18
- CASWALLC.21
- CASWALLC.23
- CASWALLC.25
- CASWALLC.40

**Lamp type**

QR-CB 51 GU5,3/GX5,3 (1) 50W 12V

**Dimensions**

H70

**CASZENO.B3.C/.. - CONVERTIBLE SYSTEM - B3**



build-in cassette for pendant with swivel - without transformer  
Einbaukassette für Pendelleuchte mit Kugelgelenk - ohne Trafo

**Dimensions**

↔ H33

**Ref cat (BAS)**

- CASZENO.B3.C.1
- CASZENO.B3.C.1M
- CASZENO.B3.C.2
- CASZENO.B3.C.4
- CASZENO.B3.C.7
- CASZENO.B3.C.11
- CASZENO.B3.C.13
- CASZENO.B3.C.14
- CASZENO.B3.C.16
- CASZENO.B3.C.18
- CASZENO.B3.C.21
- CASZENO.B3.C.23
- CASZENO.B3.C.25

Max. 300gr

**CASZENOC/.. - CONVERTIBLE SYSTEM - M10**



build-in cassette for spotlight or pendant - without transformer  
Einbaukassette für Aufbaustrahler oder Pendelleuchte - ohne Trafo

**Dimensions**

↔ H33

**Ref cat (BAS)**

- CASZENOC.1
- CASZENOC.1M
- CASZENOC.2
- CASZENOC.4
- CASZENOC.7
- CASZENOC.11
- CASZENOC.13
- CASZENOC.14
- CASZENOC.16
- CASZENOC.18
- CASZENOC.21
- CASZENOC.23
- CASZENOC.25

CASVERSOC/.. - CONVERTIBLE SYSTEM

~12V 0,0887 0,5 m 05.10.02



build-in cassette - fixed - without transformer  
Einbaukassette - fest - ohne Trafo

**Lamptype**

◁ QR-CB 51 GU5,3/GX5,3 (1) 50W 12V

**Dimensions**

↔ H75

**Ref cat (CAS)**

- CASVERSOC.1
- CASVERSOC.1M
- CASVERSOC.2
- CASVERSOC.4
- CASVERSOC.5
- CASVERSOC.7
- CASVERSOC.11
- CASVERSOC.13
- CASVERSOC.14
- CASVERSOC.16
- CASVERSOC.18
- CASVERSOC.21
- CASVERSOC.23
- CASVERSOC.25
- CASVERSOC.40

CASSAXOC/.. - CONVERTIBLE SYSTEM - M10

0,0869



build-in cassette for spotlight or pendant - without transformer  
Einbaukassette für Aufbaustrahler oder Pendelleuchte - ohne Trafo

**Dimensions**

↔ H35

**Ref cat (BAS)**

- CASSAXOC.1
- CASSAXOC.1M
- CASSAXOC.2
- CASSAXOC.4
- CASSAXOC.5
- CASSAXOC.7
- CASSAXOC.11
- CASSAXOC.13
- CASSAXOC.14
- CASSAXOC.16
- CASSAXOC.18
- CASSAXOC.21
- CASSAXOC.23

**CASVIDRIOC/.. - CONVERTIBLE SYSTEM**

~12V 0,1273 0,5 m 05.10.02



build-in cassette - without transformer  
Einbaukassette - ohne Trafo

**Lamptype**

◁ QR-CB 51 GU5,3/GX5,3 (1) 50W 12V

**Dimensions**

↔ H84

**Options**

VIDRIOGLASS/.. - CONVERTIBLE SYSTEM

**Ref cat (CAS)**

- CASVIDRIOC.1
- CASVIDRIOC.1M
- CASVIDRIOC.2
- CASVIDRIOC.4
- CASVIDRIOC.7
- CASVIDRIOC.11
- CASVIDRIOC.13
- CASVIDRIOC.14
- CASVIDRIOC.16
- CASVIDRIOC.18
- CASVIDRIOC.21

glass Ø50x84  
Glas Ø50x84

**CASFORUMC/.. - CONVERTIBLE SYSTEM**

~12V 0,1059 0,5 m 05.10.02



build-in cassette - directional - without transformer  
Einbaukassette - schwenkbar - ohne Trafo

**Lamptype**

◁ QR-CB 51 GU5,3/GX5,3 (1) 50W 12V

**Dimensions**

↔ H55

**Ref cat (CAS)**

- CASFORUMC.1
- CASFORUMC.1M
- CASFORUMC.2
- CASFORUMC.11
- CASFORUMC.14
- CASFORUMC.18
- CASFORUMC.21

**CASTURNERC/.. - CONVERTIBLE SYSTEM**

~12V 0,2400 0,5 m 05.10.02



build-in cassette - directional - without transformer  
Einbaukassette - schwenkbar - ohne Trafo

**Lamptype**

◁ QR-CB 51 GU5,3/GX5,3 (1) 50W 12V

**Dimensions**

↔ H35

**Ref cat (CAS)**

- CASTURNERC.14
- CASTURNERC.16



CASAQUANODOTC/.. - CONVERTIBLE SYSTEM

~12V



build-in cassette - fixed - with sandblasted glass - without transformer  
Einbaukassette - fest - mit sandgestrahltem Glas - ohne Trafo

**Lamptype**

◁ QR-CB 51 GU5,3/GX5,3 (1) 50W 12V

**Dimensions**

↔ H80

**Ref cat (CAS)**

- CASAQUANODOTC.1
- CASAQUANODOTC.1M
- CASAQUANODOTC.1S
- CASAQUANODOTC.2
- CASAQUANODOTC.4
- CASAQUANODOTC.7
- CASAQUANODOTC.11
- CASAQUANODOTC.11S
- CASAQUANODOTC.13
- CASAQUANODOTC.14
- CASAQUANODOTC.16
- CASAQUANODOTC.18
- CASAQUANODOTC.25

colours 1S - 11S - 25 also for bathroom (IP44)  
Farben 1S - 11S - 25 auch für Badezimmer (IP44)

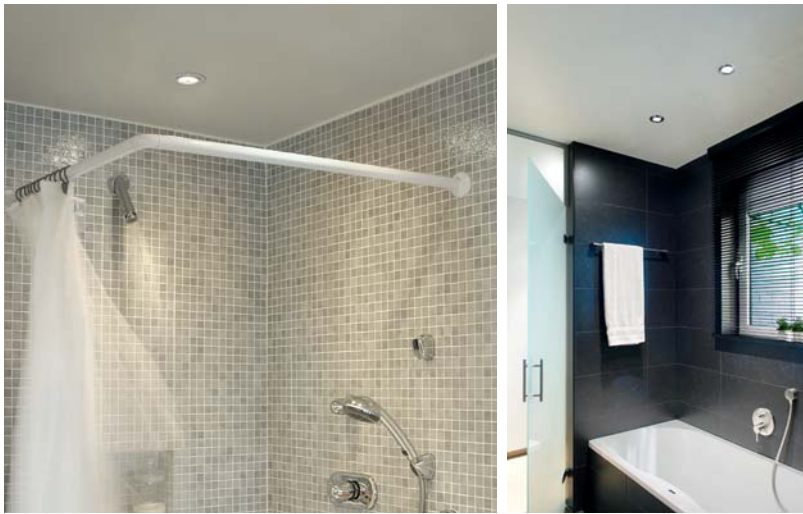

CASTARGA/.. - CONVERTIBLE SYSTEM

~12V



build-in cassette - without transformer  
Einbaukassette - ohne Trafo

**Lamptype**

◁ QR-CB 51 GU5,3/GX5,3 (1) 50W 12V

**Dimensions**

↔ H70

**Ref cat (CAS)**

- CASTARGA.1
- CASTARGA.1M
- CASTARGA.2
- CASTARGA.7
- CASTARGA.11
- CASTARGA.14
- CASTARGA.18

glass 35x35x110  
Glas 35x35x110

CASTITUSC/.. - CONVERTIBLE SYSTEM

~12V



build-in cassette - fixed - without transformer  
Einbaukassette - fest - ohne Trafo

**Lamptype**

◁ QR-CB 51 GU5,3/GX5,3 (1) 50W 12V

**Dimensions**

↔ H55

**Ref cat (CAS)**

- CASTITUSC.1
- CASTITUSC.1M
- CASTITUSC.2
- CASTITUSC.4
- CASTITUSC.7
- CASTITUSC.11
- CASTITUSC.13
- CASTITUSC.14
- CASTITUSC.16
- CASTITUSC.18

glass Ø50x73  
Glas Ø50x73

**CASPOLKA.DICRO/.. - CONVERTIBLE SYSTEM**

~12V IP20 0,1467 0,5 m 05.10.02



build-in cassette - directional - cone Ø65 H70 - without transformer  
Einbaukassette - schwenkbar - Kelch Ø65 H70 - ohne Trafo

**Lamptype**

QR-CB 51 coolfit GU5,3/GX5,3 (1) 50W 12V

**Dimensions**

H33

**Ref cat (CAS)**

- CASPOLKA.DICRO.1.1
- CASPOLKA.DICRO.1M.1M
- CASPOLKA.DICRO.2.7
- CASPOLKA.DICRO.2.40
- CASPOLKA.DICRO.7.7
- CASPOLKA.DICRO.7.40
- CASPOLKA.DICRO.11.40
- CASPOLKA.DICRO.14.40
- CASPOLKA.DICRO.18.40

use coolfit lamp  
Coolfit-Lampe verwenden

**CASPOLKA.ES50/.. - CONVERTIBLE SYSTEM**

~230V IP20 0,1556 1 m 05.10.02



build-in cassette - directional - cone Ø65 H70  
Einbaukassette - schwenkbar - Kelch Ø65 H70

**Lamptype**

QPAR 51 GU10 (1) 50W 230V

or QPAR 51 GU10 (1) 11W 230V

**Dimensions**

H33

**Ref cat (CAS)**

- CASPOLKA.ES50.1.1
- CASPOLKA.ES50.1M.1M
- CASPOLKA.ES50.2.7
- CASPOLKA.ES50.2.40
- CASPOLKA.ES50.7.7
- CASPOLKA.ES50.7.40
- CASPOLKA.ES50.11.40
- CASPOLKA.ES50.14.40
- CASPOLKA.ES50.18.40

**CASPOLKA.ES63/.. - CONVERTIBLE SYSTEM**

~230V IP20 0,1800 1 m 05.10.02



build-in cassette - directional  
Einbaukassette - schwenkbar

**Lamptype**

QPAR64 GU10 (1) 75W 230V

**Dimensions**

H33

**Ref cat (CAS)**

- CASPOLKA.ES63.1.1
- CASPOLKA.ES63.1M.1M
- CASPOLKA.ES63.2.7
- CASPOLKA.ES63.2.40
- CASPOLKA.ES63.7.7
- CASPOLKA.ES63.7.40
- CASPOLKA.ES63.11.40
- CASPOLKA.ES63.14.40
- CASPOLKA.ES63.18.40

**CASPOLKA.AR70/.. - CONVERTIBLE SYSTEM**

~12V IP20 0,1800 0,5 m 05.10.02



build-in cassette - directional - without transformer  
Einbaukassette - schwenkbar - ohne Trafo

**Lamptype**

QR-LP70 BA15d (1) 50W 12V

**Dimensions**

H33

**Ref cat (CAS)**

- CASPOLKA.AR70.1.1
- CASPOLKA.AR70.1M.1M
- CASPOLKA.AR70.2.7
- CASPOLKA.AR70.2.40
- CASPOLKA.AR70.7.7
- CASPOLKA.AR70.7.40
- CASPOLKA.AR70.11.40
- CASPOLKA.AR70.14.40
- CASPOLKA.AR70.18.40

**CASARIAC/.. - CONVERTIBLE SYSTEM**

~230V



build-in cassette - fixed  
Einbaukassette - fest

**Lamptype**

☞ QPAR 51 GU10 (1) 50W 230V  
or ☞ QPAR 51 GU10 (1) 11W 230V

**Dimensions**

↔ H90

**Ref cat (CAS)**

- CASARIAC.1
- CASARIAC.1M
- CASARIAC.2
- CASARIAC.4
- CASARIAC.5
- CASARIAC.5B
- CASARIAC.5BB
- CASARIAC.7
- CASARIAC.11
- CASARIAC.13
- CASARIAC.14
- CASARIAC.16
- CASARIAC.18
- CASARIAC.21
- CASARIAC.23
- CASARIAC.25
- CASARIAC.40

**CASCAMBIOC/.. - CONVERTIBLE SYSTEM**

~230V



build-in cassette - directional  
Einbaukassette - schwenkbar

**Lamptype**

☞ QPAR 51 GU10 (1) 50W 230V  
or ☞ QPAR 51 GU10 (1) 11W 230V

**Dimensions**

↔ H115

**Ref cat (CAS)**

- CASCAMBIOC.1
- CASCAMBIOC.1M
- CASCAMBIOC.2
- CASCAMBIOC.4
- CASCAMBIOC.5
- CASCAMBIOC.5B
- CASCAMBIOC.5BB
- CASCAMBIOC.7
- CASCAMBIOC.11
- CASCAMBIOC.13
- CASCAMBIOC.14
- CASCAMBIOC.16
- CASCAMBIOC.18
- CASCAMBIOC.21
- CASCAMBIOC.23
- CASCAMBIOC.25

CASCAMBIODOWNNC/.. - CONVERTIBLE SYSTEM

~230V



build-in cassette - directional  
Einbaukassette - schwenkbar

**Lamptype**

QPAR 51 GU10 (1) 50W 230V  
or QPAR 51 GU10 (1) 11W 230V

**Dimensions**

H135

**Ref cat (CAS)**

- CASCAMBIODOWNNC.1
- CASCAMBIODOWNNC.1M
- CASCAMBIODOWNNC.2
- CASCAMBIODOWNNC.4
- CASCAMBIODOWNNC.7
- CASCAMBIODOWNNC.11
- CASCAMBIODOWNNC.11S
- CASCAMBIODOWNNC.13
- CASCAMBIODOWNNC.14
- CASCAMBIODOWNNC.16
- CASCAMBIODOWNNC.21
- CASCAMBIODOWNNC.23
- CASCAMBIODOWNNC.40

*build-in  
with recessed light source  
mit versenkte Lichtquelle*





adaption ring - other dimensions on request  
 Adapterring - Sondermaße auf Anfrage

**ADAPTION RING FOR CONVERTIBLE SYSTEM** | Vergrootring - Anneau d'adaptation - Adapterring

**COMPOSITION | Samenstelling**



**Example**



120.80/14

1. Adaption ring - Vergrootring - Anneau d'adaptation - Adapterring

110

2. Clamp + torsion spring - Beugel + torsieveren

Carcan + ressort à torsion - Spannbügel + Torsionfeder

When placing an order, please mention the **exact opening in the ceiling**

Gelieve bij bestelling de **exacte plafondopening** te vermelden

En cas de commande, veuillez mentionner la **dimension exacte du trou au plafond**

Bitte erwähnen Sie die **genaue Öffnung in der Decke** bei Bestellung

DIVA50.14

3. Downlight

000A

4. Assembly / Montage

**100.80/.. - ADAPTION RING**

IP20



accessories - adaption ring round  
 Zubehör - Adapterring rund

**Dimensions**

Ø100

Ø80

**Ref cat (01)**

- 100.80.1
- 100.80.1M
- 100.80.2
- 100.80.4
- 100.80.5
- 100.80.5B
- 100.80.7
- 100.80.11
- 100.80.13
- 100.80.14
- 100.80.16

**120.80/.. - Ø80**

IP20



accessories - adaption ring round  
 Zubehör - Adapterring rund

**Dimensions**

Ø120

Ø80

**Ref cat (01)**

- 120.80.1
- 120.80.1M
- 120.80.2
- 120.80.4
- 120.80.5
- 120.80.5B
- 120.80.7
- 120.80.11
- 120.80.13
- 120.80.14
- 120.80.16

## INDOOR | Downlights | ADAPTION RING

adaption ring - other dimensions on request

Adapterring - Sondermaße auf Anfrage

### 140.80/.. - ADAPTION RING

IP20    0,1909 



accessories - adaption ring round  
Zubehör - Adapterring rund

#### Dimensions

 Ø140

 Ø80

#### Ref cat (01)

140.80.1  
140.80.1M  
140.80.2  
140.80.4  
140.80.5  
140.80.5B  
140.80.7  
140.80.11  
140.80.13  
140.80.14  
140.80.16

### 160.80/.. - ADAPTION RING

IP20    0,1882 



accessories - adaption ring round  
Zubehör - Adapterring rund

#### Dimensions

 Ø160

 Ø80

#### Ref cat (01)

160.80.1  
160.80.1M  
160.80.2  
160.80.4  
160.80.5  
160.80.5B  
160.80.7  
160.80.11  
160.80.13  
160.80.14  
160.80.16

### 180.80/.. - ADAPTION RING

IP20    0,3236 



accessories - adaption ring round  
Zubehör - Adapterring rund

#### Dimensions

 Ø180

 Ø80

#### Ref cat (01)

180.80.1  
180.80.1M  
180.80.2  
180.80.4  
180.80.5  
180.80.5B  
180.80.7  
180.80.11  
180.80.13  
180.80.14  
180.80.16

### 200.80/.. - ADAPTION RING

IP20    0,3891 



accessories - adaption ring round  
Zubehör - Adapterring rund

#### Dimensions

 Ø200

 Ø80

#### Ref cat (01)

200.80.1  
200.80.1M  
200.80.2  
200.80.4  
200.80.5  
200.80.5B  
200.80.7  
200.80.11  
200.80.13  
200.80.14  
200.80.16



adaption ring - other dimensions on request  
 Adapterring - Sondermaße auf Anfrage

**220.80/.. - ADAPTION RING**

IP20    0,4655 



accessories - adaption ring round  
 Zubehör - Adapterring rund

**Dimensions**  
 Ø220  
 Ø80

**Ref cat (01)**



- 220.80.1
- 220.80.1M
- 220.80.2
- 220.80.4
- 220.80.5
- 220.80.5B
- 220.80.7
- 220.80.11
- 220.80.13
- 220.80.14
- 220.80.16

**240.80/.. - ADAPTION RING**

IP20    0,4314 



accessories - adaption ring round  
 Zubehör - Adapterring rund

**Dimensions**  
 Ø240  
 Ø80

**Ref cat (01)**



- 240.80.1
- 240.80.1M
- 240.80.2
- 240.80.4
- 240.80.5
- 240.80.5B
- 240.80.7
- 240.80.11
- 240.80.13
- 240.80.14
- 240.80.16

**100.100.80/.. - ADAPTION RING**

IP20    0,0330 



accessories - adaption ring square  
 Zubehör - Adapterring quadratisch

**Dimensions**  
 L100xB100  
 Ø80

**Ref cat (01)**



- 100.100.80.1
- 100.100.80.1M
- 100.100.80.2
- 100.100.80.4
- 100.100.80.5
- 100.100.80.5B
- 100.100.80.11
- 100.100.80.13
- 100.100.80.14
- 100.100.80.16

**120.120.80/.. - ADAPTION RING**

IP20    0,0767 



accessories - adaption ring square  
 Zubehör - Adapterring quadratisch

**Dimensions**  
 L120xB120  
 Ø80

**Ref cat (01)**

- 120.120.80.1
- 120.120.80.1M
- 120.120.80.2
- 120.120.80.4
- 120.120.80.5
- 120.120.80.5B
- 120.120.80.7
- 120.120.80.11
- 120.120.80.11S
- 120.120.80.13
- 120.120.80.14
- 120.120.80.16

## INDOOR | Downlights | ADAPTION RING

adaption ring - other dimensions on request  
Adapterring - Sondermaße auf Anfrage

### 140.140.80/.. - ADAPTION RING

IP20    0,1909 



accessories - adaption ring square  
Zubehör - Adapterring quadratisch

#### Dimensions

 L140xB140

 Ø80

#### Ref cat (01)

140.140.80.1  
140.140.80.1M  
140.140.80.2  
140.140.80.4  
140.140.80.5  
140.140.80.5B  
140.140.80.7  
140.140.80.11  
140.140.80.13  
140.140.80.14  
140.140.80.16

### 160.160.80/.. - ADAPTION RING

IP20    0,2000 



accessories - adaption ring square  
Zubehör - Adapterring quadratisch

#### Dimensions

 L160xB160

 Ø80

#### Ref cat (01)

160.160.80.1  
160.160.80.1M  
160.160.80.2  
160.160.80.4  
160.160.80.5  
160.160.80.5B  
160.160.80.7  
160.160.80.11  
160.160.80.13  
160.160.80.14  
160.160.80.16

### 180.180.80/.. - ADAPTION RING

IP20    0,3236 



accessories - adaption ring square  
Zubehör - Adapterring quadratisch

#### Dimensions

 L180xB180

 Ø80

#### Ref cat (01)

180.180.80.1  
180.180.80.1M  
180.180.80.2  
180.180.80.4  
180.180.80.5  
180.180.80.5B  
180.180.80.7  
180.180.80.11  
180.180.80.13  
180.180.80.14  
180.180.80.16

### 90/.. - ADAPTION RING

S1 IP20   0,0330 



accessories - clamp + springs to be mounted on the  
roundbase  
Zubehör - Spannbügel + Torsionfeder auf dem Roundbase zu  
befestigen

#### Dimensions



 >Ø90

#### Ref cat (XX)

90

adaption ring - other dimensions on request  
 Adapterring - Sondermaße auf Anfrage

**110/.. - ADAPTION RING**

S1 IP20   0,0350 



accessories - clamp + springs to be mounted on the roundbase  
 Zubehör - Spannbügel + Torsionfeder auf dem Roundbase zu befestigen

Ref cat (XX)

110

**Dimensions**



$\text{⌀} > \text{Ø}110$

**130/.. - ADAPTION RING**

S1 IP20   0,0350 



accessories - clamp + springs to be mounted on the roundbase  
 Zubehör - Spannbügel + Torsionfeder auf dem Roundbase zu befestigen

Ref cat (XX)

130

**Dimensions**



$\text{⌀} > \text{Ø}130$

**150/.. - ADAPTION RING**

S1 IP20   0,0510 



accessories - clamp + springs to be mounted on the roundbase  
 Zubehör - Spannbügel + Torsionfeder auf dem Roundbase zu befestigen

Ref cat (XX)

150

**Dimensions**



$\text{⌀} > \text{Ø}150$

**170/.. - ADAPTION RING**

S1 IP20   0,0580 



accessories - clamp + springs to be mounted on the roundbase  
 Zubehör - Spannbügel + Torsionfeder auf dem Roundbase zu befestigen

Ref cat (XX)

170

**Dimensions**



$\text{⌀} > \text{Ø}170$

## INDOOR | Downlights | ADAPTION RING | FRAME X

adaption ring - other dimensions on request  
Adapterring - Sondermaße auf Anfrage

### 190/.. - ADAPTION RING

S1 IP20   0,0550 



accessories - clamp + springs to be mounted on the roundbase  
Zubehör - Spannbügel + Torsionfeder auf dem Roundbase zu befestigen

Ref cat (XX)

190

#### Dimensions



$\text{>}\varnothing 190$

### 210/.. - ADAPTION RING

S1 IP20   0,0750 



accessories - clamp + springs to be mounted on the roundbase  
Zubehör - Spannbügel + Torsionfeder auf dem Roundbase zu befestigen

Ref cat (XX)

210

#### Dimensions



$\text{>}\varnothing 210$

### 000A/.. - ADAPTION RING

IP20   0,0110 



accessories - assembly clamp + torsionsprings on downlight  
Zubehör - Montage des Befestigungsbügels + Torsionsfeder auf dem Einbaustrahler

Ref cat (XX)

000A

### FRAMEX/.. - SCS SYSTEM

IP20   0,0300 



build-in base - adaptor for all cassettes of Convertible System  
Einbaubasis - Adapter für alle Kassetten vom Convertible System

Ref cat (BAS)

#### Options

CASSETTES CONVERTIBLE SYSTEM

FRAMEX.1  
FRAMEX.1M  
FRAMEX.2  
FRAMEX.7  
FRAMEX.11  
FRAMEX.14  
FRAMEX.18  
FRAMEX.21

BASES

CASSETTES CONVERTIBLE SYSTEM



roundbaseUSA Ø 75-76



roundbase Ø 80



roundbase.D100 Ø 80



singlebase Ø 80



twinbase



twobase



triplebase



example  
cassaxoc  
+jupiter

example  
caszenoc  
+step

caszenoc 12V - 230V

caszeno.B3.c  
12V - 230V

enkel voor pendel  
seulement pour suspension  
only for pendant  
nur für Pendelleuchte

spot of pendel afzonderlijk te bestellen | spot ou suspension à commander séparément  
spot or pendant to order separately | Spot oder Pendelleuchte separat bestellen



frame1A 100x100

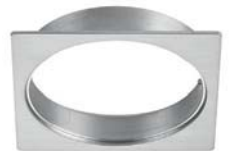

frame X adaptateur



casdivac 12V



frame1a + framex +  
casdivac

Downlights indoor

Het "Square click system" past probleemloos op ons bestaande "Convertible system" en laat een breed spectrum van kleuren en materialen toe, gaande van wit, zwart, chroom over metaalgrijns tot alu satine en parelchrommat.

Dankzij het **Frame X** kunnen alle cassettes van het Convertible System moeiteloos in de Frames van het SCS ingepast worden.

Als je dan ook nog weet dat quasi elk type lamp er in aangesloten kan worden, mag je gerust besluiten dat het nooit eerder zo makkelijk was je omgeving juist te verlichten.

**Creer! Wanneer je maar wil!**

The "Square Click System" matches perfectly with PSM Lightings existing "Convertible system" and is available in a wide variety of colours and materials, such as white, black, chrome, metal grey, satin finished aluminium and pearlchrome matt.

Thanks to the **Frame X**, all Convertible System cassettes can easily be fitted into the SCS frames.

Considering that virtually any type of bulb can be used, you will agree that it has never been so easy to perfectly illuminate your home.

**Create whatever you want! Whenever you want!**

Le "Square Click System" s'adapte sans difficulté au "Convertible system" de PSM Lighting, et se décline dans une large palette de coloris et de matériaux, du blanc, noir, chrome, au perle chrome mat, gris métal et alu satiné.

Grâce au **Frame X** toutes les cassettes du **Convertible System** s'emboîtent facilement dans les frames du Square Click System.

Sachez en outre que presque tous les types de lampes peuvent être utilisés, et vous conviendrez avec nous qu'il n'a jamais été aussi facile d'éclairer votre intérieur comme il faut.

**Créez ce que vous voulez, quand vous voulez!**

Das "Square Click System" passt in unserem bestehenden "Convertible System" und ist in einer großen Vielfalt an Farben und Rohstoffen verfügbar, wie Weiß, Schwarz, Chrom, sowie Metallgrau, Alu satiniert und Mattperlchrom.

Dank dem **Frame X** können alle Kassetten des Convertible Systems mühelos in die Frames des Square Click Systems eingefügt werden.

Berücksichtigend, dass fast jeder Lampentyp angewendet werden kann, dürfen Sie sicher feststellen, dass es nie so einfach war Ihre Wohnung richtig zu beleuchten.

**Kreieren Sie, ganz gleich wann!**

# SQUARE CLICK SYSTEM (SCS)

## BASES | Ø90 FRAME A



frame1A 100x100



frame2A



frame3A

## BASES | Ø85-87 FRAME B



frame1B 100x100



frame2B



frame3B

## CASSETTES



casvolta (richtbaar - orientable)



cassamba (richtbaar - orientable)



casanka (richtbaar - orientable)



caslimbo (richtbaar - orientable)



casouzo (vast-fix)



casalto (AR70-ES63)



cascomo (vast-fix)



casroma (vast-fix)



casconga (vast-fix)



voorbeeld - example frame1a + casconga



casmimba



casdana



casvera



casriga plexi (micro-lynx)



casriga glass (DICRO-ES50)



cassula (down)



castinto (down)



cascinto (down)



caszorba (down)



castomba (down)

### frame1a + castomba



frame1a + castomba



frame2a + 2 x cassamba



caszero



caszero + condor



caszerob3

spot of pendel afzonderlijk te bestellen  
spot ou suspension à commander séparément  
Spot oder Pendelleuchte separat bestellen

enkel voor pendel  
seulement pour suspension  
only for pendant  
Nur für pendelleuchte



**FRAME1A/.. - Ø90 SCS SYSTEM**

S2 IP20    0,0963 

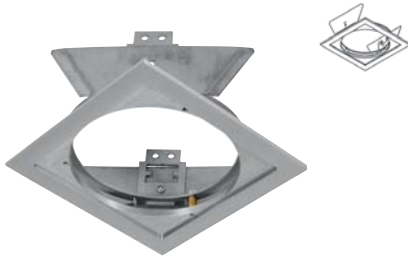

build-in base for cassette - square  
Einbaubasis für Kassette - viereckig

**Dimensions**

↔ L100xB100xH30

 Ø90  33

**Options**

CASSETTES SQUARE CLICK SYSTEM  
S6.90/.. - PLASTERKIT

**Ref cat (BAS)**

FRAME1A.1  
FRAME1A.1M  
FRAME1A.2  
FRAME1A.7  
FRAME1A.11  
FRAME1A.14  
FRAME1A.18  
FRAME1A.21

build-in

**FRAME1B/.. - Ø85-87 SCS SYSTEM**

S2 IP20    0,0525 

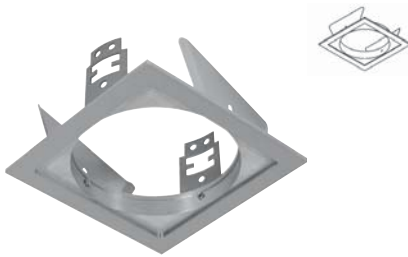

build-in base for cassette - square  
Einbaubasis für Kassette - viereckig

**Dimensions**

↔ L100xB100

 Ø85-87

**Options**

CASSETTES SQUARE CLICK SYSTEM  
S6.87/.. - PLASTERKIT

**Ref cat (BAS)**

FRAME1B.1  
FRAME1B.1M  
FRAME1B.2  
FRAME1B.7  
FRAME1B.11  
FRAME1B.14  
FRAME1B.18  
FRAME1B.21

build-in

**FRAME1BBOX/.. - SCS SYSTEM**

IP20  

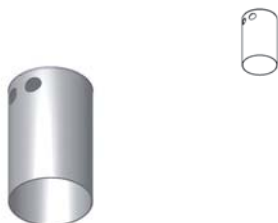

accessories - mould for Frame1B  
Zubehör - Gießform für Frame1B

**Dimensions**

↔ Ø88,5xH140

**Ref cat (XX)**

FRAME1BBOX

**FRAME1BMATRIX/.. - SCS SYSTEM**

IP20  

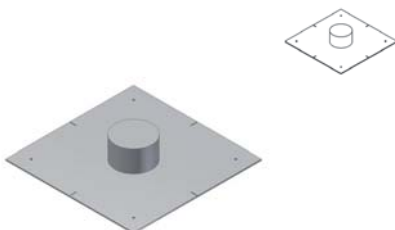

accessories - matrix for Frame1B  
Zubehör - Matrice für Frame1B

**Dimensions**

↔ L300xB300

**Ref cat (XX)**

FRAME1BMATRIX

**FRAME2A/.. - 2xØ90 SCS SYSTEM**

S1 IP20    0,1662 

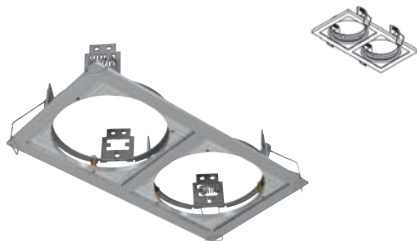

build-in base for 2 cassettes - square  
Einbaubasis für 2 Kassetten - viereckig

**Dimensions**

↔ L190xB100  
🔧 2xØ90 ⚙️ [90]

**Options**

CASSETTES SQUARE CLICK SYSTEM  
S7.90/.. - PLASTERKIT

**Ref cat (BAS)**

FRAME2A.1  
FRAME2A.1M  
FRAME2A.2  
FRAME2A.7  
FRAME2A.11  
FRAME2A.14  
FRAME2A.18  
FRAME2A.21

build-in

**FRAME2B/.. - 2xØ85-87 SCS SYSTEM**

S1 IP20    0,1662 

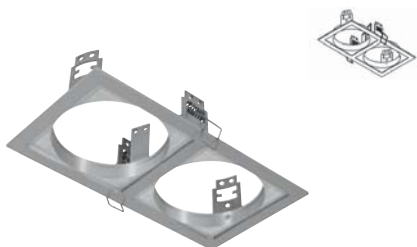

build-in base for 2 cassettes - square  
Einbaubasis für 2 Kassetten - viereckig

**Dimensions**

↔ L190xB100  
🔧 2xØ85-87 ⚙️ [92]

**Options**

CASSETTES SQUARE CLICK SYSTEM  
S7.87/.. - PLASTERKIT

**Ref cat (BAS)**

FRAME2B.1  
FRAME2B.1M  
FRAME2B.2  
FRAME2B.7  
FRAME2B.11  
FRAME2B.14  
FRAME2B.18  
FRAME2B.21

build-in

**FRAME2BBOX/.. - SCS SYSTEM**

IP20  



accessories - mould for Frame2B  
Zubehör - Gießform für Frame2B

**Dimensions**

↔ L175xB88,5xH138

**Ref cat (XX)**

FRAME2BBOX

**FRAME2BMATRIX/.. - SCS SYSTEM**

IP20  

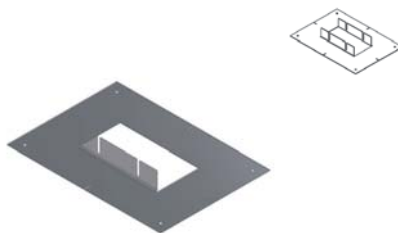

accessories - matrix for Frame2B  
Zubehör - Matrice für Frame2B

**Dimensions**

↔ L300xB250

**Ref cat (XX)**

FRAME2BMATRIX

**FRAME3A/.. - 3xØ90 SCS SYSTEM**

S1 IP20    0.2363 

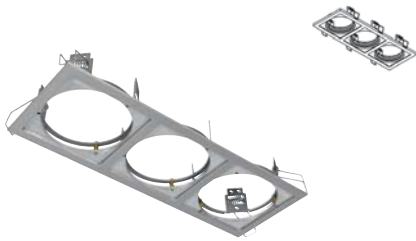

build-in base for 3 cassettes - square  
Einbaubasis für 3 Kassetten - viereckig

**Dimensions**

↔ L280xB100  
📏 3xØ90 ⚙️ [90][90]

**Options**

CASSETTES SQUARE CLICK SYSTEM  
S8.90/.. - PLASTERKIT

**Ref cat (BAS)**

FRAME3A.1  
FRAME3A.1M  
FRAME3A.2  
FRAME3A.7  
FRAME3A.11  
FRAME3A.14  
FRAME3A.18  
FRAME3A.21

build-in

**FRAME3B/.. - 3xØ85-87 SCS SYSTEM**

S1 IP20    0.2713 

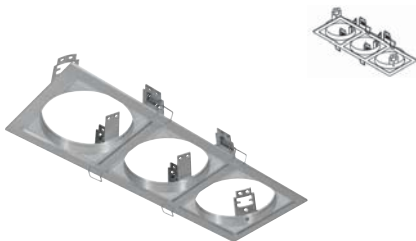

build-in base for 3 cassettes - square  
Einbaubasis für 3 Kassetten - viereckig

**Dimensions**

↔ L280xB100  
📏 3xØ85-87 ⚙️ [92][92]

**Options**

CASSETTES SQUARE CLICK SYSTEM  
S8.87/.. - PLASTERKIT

**Ref cat (BAS)**

FRAME3B.1  
FRAME3B.1M  
FRAME3B.2  
FRAME3B.7  
FRAME3B.11  
FRAME3B.14  
FRAME3B.18  
FRAME3B.21

build-in

**FRAME3BBOX/.. - SCS SYSTEM**

IP20  

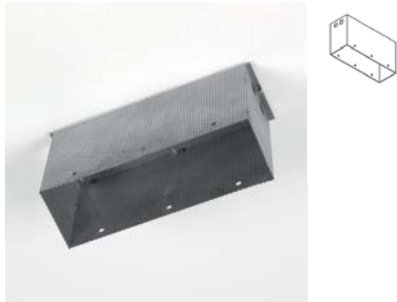

accessories - mould for Frame3B  
Zubehör - Gießform für Frame3B

**Dimensions**

↔ L270xB88,5xH138

**Ref cat (XX)**

FRAME3BBOX

**FRAME3BMATRIX/.. - SCS SYSTEM**

IP20  

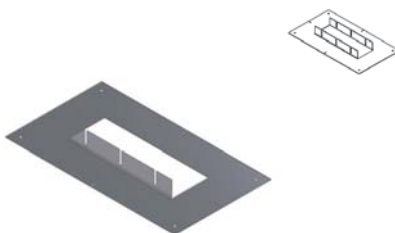

accessories - matrix for Frame3B  
Zubehör - Matrice für Frame3B

**Dimensions**

↔ L440xB250

**Ref cat (XX)**

FRAME3BMATRIX

**FRAME1C/.. - SCS SYSTEM**

IP20    0,7000 



build-in base for cassette - square  
Einbaubasis für Kassette - viereckig

**Dimensions**

↔ L100xB100

**Options**

CASSETTES SQUARE CLICK SYSTEM

**Ref cat (BAS)**

FRAME1C.1  
FRAME1C.1M  
FRAME1C.2  
FRAME1C.7  
FRAME1C.11  
FRAME1C.14  
FRAME1C.18  
FRAME1C.21

**MATRIX1C/.. - SCS SYSTEM**

IP20  



matrix  
Matrize

**Dimensions**

↔ L350xB350

**Ref cat (XX)**

MATRIX1C

**INSERTBOX1C/.. - SCS SYSTEM**

IP20  



build-in box  
Einbaudose

**Dimensions**

↔ L145xB145xH125-155

**Ref cat (XX)**

INSERTBOX1C

**FRAME2C/.. - SCS SYSTEM**

IP20    0,9000 

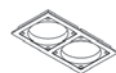

build-in base for 2 cassettes - square  
Einbaubasis für 2 Kassetten - viereckig

**Dimensions**

↔ L190xB100

**Options**

CASSETTES SQUARE CLICK SYSTEM

**Ref cat (BAS)**

FRAME2C.1  
FRAME2C.1M  
FRAME2C.2  
FRAME2C.7  
FRAME2C.11  
FRAME2C.14  
FRAME2C.18  
FRAME2C.21

**MATRIX2C/.. - SCS SYSTEM**

IP20  

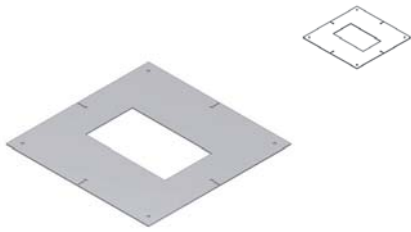

matrix  
Matrize

**Dimensions**

↔ L350xB350

**Ref cat (XX)**

MATRIX2C

**INSERTBOX2C/.. - SCS SYSTEM**

IP20  



build-in box  
Einbaudose

**Dimensions**

↔ L240xB145xH125-150

**Ref cat (XX)**

INSERTBOX2C

**FRAME3C/.. - SCS SYSTEM**

IP20    0,9000 



build-in base for 3 cassettes - square  
Einbaubasis für 3 Kassetten - viereckig

**Dimensions**

↔ L280xB100

**Options**

CASSETTES SQUARE CLICK SYSTEM

**Ref cat (BAS)**

- FRAME3C.1
- FRAME3C.1M
- FRAME3C.2
- FRAME3C.7
- FRAME3C.11
- FRAME3C.14
- FRAME3C.18
- FRAME3C.21

**MATRIX3C/.. - SCS SYSTEM**

IP20  

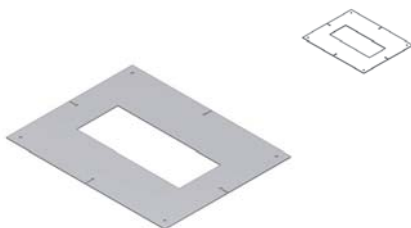

matrix  
Matrize

**Dimensions**

↔ L350xB350

**Ref cat (XX)**

MATRIX3C

INSERTBOX3C/.. - SCS SYSTEM

IP20  



build-in box  
Einbaudose

Dimensions

↔ L330xB145xH125-150

Ref cat (XX)

INSERTBOX3C





**Vakman, gedaan met puzzelen !**

Een spot plaatsen lijkt al te vaak op eindeloos puzzelwerk.

Daarom bedachten wij het multifunctionele **Square Click System**

Een standaard ronde opening volstaat om vervolgens het SCS-frame in te plaatsen waarin je op haar beurt je favoriete SCS-cassette klikt !

Voortaan past vierkant wél in rond, zelfs richtbaar, kantelbaar, inbouw, opbouw, gependeld, design of klassiek .... werkelijk alles is mogelijk.

Omdat PSM niet spot met puzzels, puzzel jij niet langer met spots

**Eindelijk belicht je je omgeving in een handomdraai 100% naar wens.**

**Cher installateur, vous n'aurez plus à bricoler!**

Placer un spot revient trop souvent à tenter d'assembler les pièces d'un puzzle infini.

C'est pourquoi nous avons inventé le **Square Click System** polyvalent.

Dans une ouverture ronde standard, installez le cadre SCS, dans lequel il vous suffit ensuite de cliquer la cassette SCS de votre choix !

La quadrature du cercle enfin résolue: spot orientable, pivotant, encastré, apparent ou suspension, design moderne ou classique ... tout devient possible.

Avec PSM, vous ne vous cassez plus la tête à tenter d'assembler les pièces d'un puzzle.

**Eclairez enfin votre intérieur dans un clin d'oeil exactement comme vous le voulez.**

**Spotlight installation no longer a puzzle!**

Sometimes installing a spotlight can be quite a puzzle. That's why we have devised the multifunctional **Square Click System**.

A standard round cutout is all you need to install the SCS frame in which you can then click your favourite SCS cassette. Combining square and round is therefore no longer a problem. Our range furthermore has tiltable, directional, recessed, surface-mounted, pendants or spotlights with a modern or a classic design ... the choice is truly endless.

PSM has shone a light on puzzles, so you no longer have to puzzle over light.

**Finally a system to illuminate your environment entirely to your liking in less than no time.**

**Fachmann, es ist vorbei mit dem Puzzeln!**

Einen Scheinwerfer montieren scheint allzu oft eine endlose Puzzlearbeit zu sein. Deshalb haben wir das multifunktionelle **Square Click System** entworfen.

Eine normale runde Öffnung reicht aus, um darin den SCS-Rahmen zu montieren, in den Sie anschließend die SCS-Kassette Ihrer Wahl klicken ... Nun passt das Viereckige tatsächlich in das Runde, sogar schwenkbar, drehbar, Einbau, Aufbau, Pendelleuchte, Design oder Klassik ... wirklich alles ist möglich.

Weil PSM nicht mit Puzzeln spottet, puzzeln Sie nicht mehr mit den Spots.

**Endlich beleuchten Sie Ihre Umgebung im Handumdrehen 100 % nach Wunsch.**

**CASSAMBA.DICRO/.. - SCS SYSTEM**

~12V

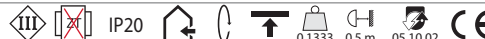

build-in cassette - directional - without transformer  
Einbaukassette - schwenkbar - ohne Trafo

**Lamptype**

◀ QR-CB 51 GU5,3/GX5,3 (1) 50W 12V

**Dimensions**

↔ H70-90

**Ref cat (CAS)**

- CASSAMBA.DICRO.1
- CASSAMBA.DICRO.1M
- CASSAMBA.DICRO.2
- CASSAMBA.DICRO.7
- CASSAMBA.DICRO.11
- CASSAMBA.DICRO.14.2
- CASSAMBA.DICRO.14.14
- CASSAMBA.DICRO.18
- CASSAMBA.DICRO.21

**CASSAMBA.ES50/.. - SCS SYSTEM**

~230V



build-in cassette - directional  
Einbaukassette - schwenkbar

**Lamptype**

◀ QPAR 51 GU10 (1) 50W 230V

or ◀ QPAR 51 GU10 (1) 11W 230V

**Dimensions**

↔ H75-95

**Ref cat (CAS)**

- CASSAMBA.ES50.1
- CASSAMBA.ES50.1M
- CASSAMBA.ES50.2
- CASSAMBA.ES50.7
- CASSAMBA.ES50.11
- CASSAMBA.ES50.14.2
- CASSAMBA.ES50.14.40
- CASSAMBA.ES50.18
- CASSAMBA.ES50.21

**CASANKA.DICRO/.. - SCS SYSTEM**

~12V

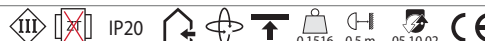

build-in cassette - directional - without transformer  
Einbaukassette - schwenkbar - ohne Trafo

**Lamptype**

◀ QR-CB 51 GU5,3/GX5,3 (1) 50W 12V

**Dimensions**

↔ H70-90

**Ref cat (CAS)**

- CASANKA.DICRO.1
- CASANKA.DICRO.1M
- CASANKA.DICRO.2
- CASANKA.DICRO.7
- CASANKA.DICRO.11
- CASANKA.DICRO.14.2
- CASANKA.DICRO.14.14
- CASANKA.DICRO.18
- CASANKA.DICRO.21

**CASANKA.ES50/.. - SCS SYSTEM**

~230V



build-in cassette - directional  
Einbaukassette - schwenkbar

**Lamptype**

◀ QPAR 51 GU10 (1) 50W 230V

or ◀ QPAR 51 GU10 (1) 11W 230V

**Dimensions**

↔ H75-95

**Ref cat (CAS)**

- CASANKA.ES50.1
- CASANKA.ES50.1M
- CASANKA.ES50.2
- CASANKA.ES50.7
- CASANKA.ES50.11
- CASANKA.ES50.14.2
- CASANKA.ES50.14.40
- CASANKA.ES50.18
- CASANKA.ES50.21



**CASSULA.CDMTM/.. - SCS SYSTEM**

~230V



build-in cassette - fixed - without gear  
Einbaukassette - fest - ohne Vorschaltgerät

**Lamp type**

HIT-TC-CE PGJ5 (1) 20W

230V

**Dimensions**

↔ H90

**Ref cat (CAS)**

- CASSULA.CDMTM.1.7
- CASSULA.CDMTM.1M.7
- CASSULA.CDMTM.2.7
- CASSULA.CDMTM.7.7
- CASSULA.CDMTM.11.7
- CASSULA.CDMTM.14.7
- CASSULA.CDMTM.21.7

**CASSULA.HCITF/.. - SCS SYSTEM**

~230V



build-in cassette - fixed - without gear  
Einbaukassette - fest - ohne Vorschaltgerät

**Lamp type**

HIT-TC-CE GU6,5 (1) 35W

230V

**Dimensions**

↔ H90

**Ref cat (CAS)**

- CASSULA.HCITF.1.7
- CASSULA.HCITF.1M.7
- CASSULA.HCITF.2.7
- CASSULA.HCITF.7.7
- CASSULA.HCITF.11.7
- CASSULA.HCITF.14.7
- CASSULA.HCITF.21.7

**CASZERO/.. - SCS SYSTEM - M10**



build-in cassette for spotlight or pendant - without transformer  
Einbaukassette für Aufbaustrahler oder Pendelleuchte - ohne Trafo

**Dimensions**

↔ H50

**Ref cat (BAS)**

- CASZERO.1
- CASZERO.1M
- CASZERO.2
- CASZERO.7
- CASZERO.11
- CASZERO.14
- CASZERO.18
- CASZERO.21

**CASZEROB3/.. - SCS SYSTEM - B3**



build-in cassette for pendant with swivel - without transformer  
Einbaukassette für Pendelleuchte mit Kugelgelenk - ohne Trafo

**Dimensions**

↔ H50

**Ref cat (BAS)**

- CASZEROB3.1
- CASZEROB3.1M
- CASZEROB3.2
- CASZEROB3.7
- CASZEROB3.11
- CASZEROB3.14
- CASZEROB3.18
- CASZEROB3.21

CASROMA.DICRO/.. - SCS SYSTEM

~12V



build-in cassette - fixed - without transformer  
Einbaukassette - fest - ohne Trafo

**Lamptype**

◀ QR-CB 51 GU5,3/GX5,3 (1) 50W 12V

**Dimensions**

↔ H60-80

**Ref cat (CAS)**

- CASROMA.DICRO.1
- CASROMA.DICRO.1M
- CASROMA.DICRO.2
- CASROMA.DICRO.7
- CASROMA.DICRO.11
- CASROMA.DICRO.14.2
- CASROMA.DICRO.14.40
- CASROMA.DICRO.18
- CASROMA.DICRO.21

CASROMA.ES50/.. - SCS SYSTEM

~230V



build-in cassette - fixed  
Einbaukassette - fest

**Lamptype**

◀ QPAR 51 GU10 (1) 50W 230V

or ◀ QPAR 51 GU10 (1) 11W 230V

**Dimensions**

↔ H70-90

**Ref cat (CAS)**

- CASROMA.ES50.1
- CASROMA.ES50.1M
- CASROMA.ES50.2
- CASROMA.ES50.7
- CASROMA.ES50.11
- CASROMA.ES50.14.2
- CASROMA.ES50.14.40
- CASROMA.ES50.18
- CASROMA.ES50.21

CASCONGA.DICRO/.. - SCS SYSTEM

~12V



build-in cassette - fixed - without transformer  
Einbaukassette - fest - ohne Trafo

**Lamptype**

◀ QR-CB 51 GU5,3/GX5,3 (1) 50W 12V

**Dimensions**

↔ H70-90

**Ref cat (CAS)**

- CASCONGA.DICRO.1
- CASCONGA.DICRO.1M
- CASCONGA.DICRO.2
- CASCONGA.DICRO.7
- CASCONGA.DICRO.11
- CASCONGA.DICRO.14.2
- CASCONGA.DICRO.14.40
- CASCONGA.DICRO.18
- CASCONGA.DICRO.21

CASCONGA.ES50/.. - SCS SYSTEM

~230V



build-in cassette - fixed  
Einbaukassette - fest

**Lamptype**

◀ QPAR 51 GU10 (1) 50W 230V

or ◀ QPAR 51 GU10 (1) 11W 230V

**Dimensions**

↔ H80-100

**Ref cat (CAS)**

- CASCONGA.ES50.1
- CASCONGA.ES50.1M
- CASCONGA.ES50.2
- CASCONGA.ES50.7
- CASCONGA.ES50.11
- CASCONGA.ES50.14.2
- CASCONGA.ES50.14.40
- CASCONGA.ES50.18
- CASCONGA.ES50.21

**CASTOMBA.DICRO/.. - SCS SYSTEM**

~12V



build-in cassette - fixed - without transformer  
Einbaukassette - fest - ohne Trafo

**Lamptype**

◁ QR-CB 51 GU5,3/GX5,3 (1) 50W 12V

**Dimensions**

↔ H90-110

**Ref cat (CAS)**

- CASTOMBA.DICRO.1
- CASTOMBA.DICRO.1M
- CASTOMBA.DICRO.2
- CASTOMBA.DICRO.7
- CASTOMBA.DICRO.7.40
- CASTOMBA.DICRO.11.40
- CASTOMBA.DICRO.14.2
- CASTOMBA.DICRO.14.40
- CASTOMBA.DICRO.18
- CASTOMBA.DICRO.21

**CASTOMBA.ES50/.. - SCS SYSTEM**

~230V



build-in cassette - fixed  
Einbaukassette - fest

**Lamptype**

◁ QPAR 51 GU10 (1) 50W 230V

or ◁ QPAR 51 GU10 (1) 11W 230V

**Dimensions**

↔ H90-110

**Ref cat (CAS)**

- CASTOMBA.ES50.1
- CASTOMBA.ES50.1M
- CASTOMBA.ES50.2
- CASTOMBA.ES50.7.40
- CASTOMBA.ES50.11.40
- CASTOMBA.ES50.14.2
- CASTOMBA.ES50.14.40
- CASTOMBA.ES50.18
- CASTOMBA.ES50.21

**CASZORBA.DICRO/.. - SCS SYSTEM**

~12V



build-in cassette - fixed - without transformer  
Einbaukassette - fest - ohne Trafo

**Lamptype**

◁ QR-CB 51 GU5,3/GX5,3 (1) 50W 12V

**Dimensions**

↔ H70-95

**Ref cat (CAS)**

- CASZORBA.DICRO.1
- CASZORBA.DICRO.1M
- CASZORBA.DICRO.2
- CASZORBA.DICRO.7.40
- CASZORBA.DICRO.11.40
- CASZORBA.DICRO.14.2
- CASZORBA.DICRO.14.40
- CASZORBA.DICRO.18
- CASZORBA.DICRO.21

**CASZORBA.ES50/.. - SCS SYSTEM**

~230V



build-in cassette - fixed  
Einbaukassette - fest

**Lamptype**

◁ QPAR 51 GU10 (1) 50W 230V

or ◁ QPAR 51 GU10 (1) 11W 230V

**Dimensions**

↔ H80-100

**Ref cat (CAS)**

- CASZORBA.ES50.1
- CASZORBA.ES50.1M
- CASZORBA.ES50.2
- CASZORBA.ES50.7.40
- CASZORBA.ES50.11.40
- CASZORBA.ES50.14.2
- CASZORBA.ES50.14.40
- CASZORBA.ES50.18
- CASZORBA.ES50.21

**CASMIMBA.DICRO/.. - SCS SYSTEM**

~12V



build-in cassette - glass H80mm - without transformer  
Einbaukassette - Glas H80mm - ohne Trafo

**Lamptype**

◀ QR-CB 51 GU5,3/GX5,3 (1) 50W 12V

**Dimensions**

↔ H70

**Ref cat (CAS)**

- CASMIMBA.DICRO.1
- CASMIMBA.DICRO.1M
- CASMIMBA.DICRO.2
- CASMIMBA.DICRO.7
- CASMIMBA.DICRO.11
- CASMIMBA.DICRO.14

**CASMIMBA.ES50/.. - SCS SYSTEM**

~230V



build-in cassette - glass H80mm  
Einbaukassette - Glas H80mm

**Lamptype**

◀ QPAR 51 GU10 (1) 50W 230V

or ◀ QPAR 51 GU10 (1) 11W 230V

**Dimensions**

↔ H80

**Ref cat (CAS)**

- CASMIMBA.ES50.1
- CASMIMBA.ES50.1M
- CASMIMBA.ES50.2
- CASMIMBA.ES50.7
- CASMIMBA.ES50.11
- CASMIMBA.ES50.14

**CASRIGAGLDICRO/.. - SCS SYSTEM**

~12V



build-in cassette - without transformer  
Einbaukassette - ohne Trafo

**Lamptype**

◀ QR-CB 51 GU5,3/GX5,3 (1) 50W 12V

**Dimensions**

↔ H65-85

**Ref cat (CAS)**

- CASRIGAGLDICRO.1
- CASRIGAGLDICRO.1M
- CASRIGAGLDICRO.2
- CASRIGAGLDICRO.7
- CASRIGAGLDICRO.11
- CASRIGAGLDICRO.14
- CASRIGAGLDICRO.18

**CASRIGAGLES50/.. - SCS SYSTEM**

~230V



build-in cassette  
Einbaukassette

**Lamptype**

◀ QPAR 51 GU10 (1) 50W 230V

or ◀ QPAR 51 GU10 (1) 11W 230V

**Dimensions**

↔ H70-90

**Ref cat (CAS)**

- CASRIGAGLES50.1
- CASRIGAGLES50.1M
- CASRIGAGLES50.2
- CASRIGAGLES50.7
- CASRIGAGLES50.11
- CASRIGAGLES50.14
- CASRIGAGLES50.18

**CASRIGAMICRO/.. - SCS SYSTEM**

~230V



build-in cassette  
Einbaukassette

**Lamptype**

TC-FSE GX53 (1) 6W

230V

**Dimensions**

↔ H50-70

**Ref cat (CAS)**

- CASRIGAMICRO.1
- CASRIGAMICRO.1M
- CASRIGAMICRO.2
- CASRIGAMICRO.7
- CASRIGAMICRO.11
- CASRIGAMICRO.14
- CASRIGAMICRO.18

**CASDANA.E14/.. - SCS SYSTEM**

~230V



build-in cassette  
Einbaukassette

**Lamptype**

biax GE E14 (1) 15W

230V

**Dimensions**

↔ H80-115

**Ref cat (CAS)**

CASDANA.E14

**CASDANA.E27/.. - SCS SYSTEM**

~230V



build-in cassette  
Einbaukassette

**Lamptype**

TC-HSE E27 (1) 15W

230V

**Dimensions**

↔ H80-115

**Ref cat (CAS)**

CASDANA.E27

**CASVERA.E14/.. - SCS SYSTEM**

~230V



build-in cassette  
Einbaukassette

**Lamptype**

biax GE E14 (1) 15W

230V

**Dimensions**

↔ H80-115

**Ref cat (CAS)**

CASVERA.E14

CASVERA.E27/.. - SCS SYSTEM

~230V



build-in cassette  
Einbaukassette

Ref cat (CAS)

CASVERA.E27

Lamptype

TC-HSE E27 (1) 15W 230V

Dimensions

H80-115

CASLIMBO.DICRO/.. - SCS SYSTEM

~12V



build-in cassette - directional - without transformer  
Einbaukassette - schwenkbar - ohne Trafo

Ref cat (CAS)

CASLIMBO.DICRO.1

CASLIMBO.DICRO.1M

CASLIMBO.DICRO.2

CASLIMBO.DICRO.7

CASLIMBO.DICRO.11

CASLIMBO.DICRO.14

CASLIMBO.DICRO.14.40

CASLIMBO.DICRO.18

CASLIMBO.DICRO.21

Lamptype

QR-CB 51 GU5,3/GX5,3 (1) 50W 12V

Dimensions

H70-90

CASLIMBO.ES50/.. - SCS SYSTEM

~230V



build-in cassette - directional  
Einbaukassette - schwenkbar

Ref cat (CAS)

CASLIMBO.ES50.1

CASLIMBO.ES50.1M

CASLIMBO.ES50.2

CASLIMBO.ES50.7

CASLIMBO.ES50.11

CASLIMBO.ES50.14.2

CASLIMBO.ES50.14.40

CASLIMBO.ES50.18

CASLIMBO.ES50.21

Lamptype

QPAR 51 GU10 (1) 50W 230V  
or QPAR 51 GU10 (1) 11W 230V

Dimensions

H75-95

CASCOMO.DICRO/.. - SCS SYSTEM

~12V



build-in cassette - fixed - without transformer  
Einbaukassette - fest - ohne Trafo

Ref cat (CAS)

CASCOMO.DICRO.1

CASCOMO.DICRO.1M

CASCOMO.DICRO.2

CASCOMO.DICRO.7

CASCOMO.DICRO.11

CASCOMO.DICRO.14

CASCOMO.DICRO.18

CASCOMO.DICRO.21

Lamptype

QR-CB 51 GU5,3/GX5,3 (1) 50W 12V

Dimensions

H60-80

CASCOMO.ES50/.. - SCS SYSTEM

~230V  IP20   0,1225 1 m  05.10.02 



build-in cassette - fixed  
Einbaukassette - fest

**Lamptype**

 QPAR 51 GU10 (1) 50W 230V  
or  QPAR 51 GU10 (1) 11W 230V

**Dimensions**

 H70-90

**Ref cat (CAS)**

- CASCOMO.ES50.1
- CASCOMO.ES50.1M
- CASCOMO.ES50.2
- CASCOMO.ES50.7
- CASCOMO.ES50.11
- CASCOMO.ES50.14
- CASCOMO.ES50.18
- CASCOMO.ES50.21

CASOUZO.DICRO/.. - SCS SYSTEM

~12V   IP20   0,1067 0,5 m  05.10.02 



build-in cassette - fixed - without transformer  
Einbaukassette - fest - ohne Trafo

**Lamptype**

 QR-CB 51 GU5,3/GX5,3 (1) 50W 12V

**Dimensions**

 H60-80

**Ref cat (CAS)**

- CASOUZO.DICRO.1
- CASOUZO.DICRO.1M
- CASOUZO.DICRO.2
- CASOUZO.DICRO.7
- CASOUZO.DICRO.11
- CASOUZO.DICRO.14
- CASOUZO.DICRO.14.40
- CASOUZO.DICRO.18
- CASOUZO.DICRO.21

CASOUZO.ES50/.. - SCS SYSTEM

~230V  IP20   0,1244 1 m  05.10.02 



build-in cassette - fixed  
Einbaukassette - fest

**Lamptype**

 QPAR 51 GU10 (1) 50W 230V  
or  QPAR 51 GU10 (1) 11W 230V

**Dimensions**

 H70-90

**Ref cat (CAS)**

- CASOUZO.ES50.1
- CASOUZO.ES50.1M
- CASOUZO.ES50.2
- CASOUZO.ES50.7
- CASOUZO.ES50.11
- CASOUZO.ES50.14.2
- CASOUZO.ES50.14.40
- CASOUZO.ES50.18
- CASOUZO.ES50.21

CASALTOAR70/.. - SCS SYSTEM

~12V   IP20   0,1400 0,5 m  05.10.02 



build-in cassette - fixed - without transformer  
Einbaukassette - fest - ohne Trafo

**Lamptype**

 QR-LP70 BA15d (1) 50W 12V

**Dimensions**

 H85-105

**Ref cat (CAS)**

- CASALTOAR70.1
- CASALTOAR70.1M
- CASALTOAR70.2
- CASALTOAR70.7
- CASALTOAR70.11
- CASALTOAR70.14
- CASALTOAR70.18
- CASALTOAR70.21

**CASALTOES63/.. - SCS SYSTEM**

~230V  IP20    0,0210  1 m  05.10.02 



build-in cassette - fixed  
Einbaukassette - fest

**Lamptype**

 QPAR64 GU10 (1) 75W 230V

**Dimensions**

 H75-105

**Ref cat (CAS)**

- CASALTOES63.1
- CASALTOES63.1M
- CASALTOES63.2
- CASALTOES63.7
- CASALTOES63.11
- CASALTOES63.14
- CASALTOES63.18
- CASALTOES63.21

**CASVOLTA.DICRO/.. - SCS SYSTEM**

~12V   IP20    0,2291  0,5 m  05.10.02 



build-in cassette - directional - without transformer  
Einbaukassette - schwenkbar - ohne Trafo

**Lamptype**

 QR-CB 51 GU5,3/GX5,3 (1) 50W 12V

**Dimensions**

 H50-70

**Ref cat (CAS)**

- CASVOLTA.DICRO.1.1
- CASVOLTA.DICRO.1M.40
- CASVOLTA.DICRO.2.7
- CASVOLTA.DICRO.2.40
- CASVOLTA.DICRO.7.7
- CASVOLTA.DICRO.7.40
- CASVOLTA.DICRO.11.40
- CASVOLTA.DICRO.14.40
- CASVOLTA.DICRO.18.40
- CASVOLTA.DICRO.21.40

cone Ø65xH70  
Kelch Ø65xH70

**CASVOLTA.ES50/.. - SCS SYSTEM**

~230V  IP20    0,1800  1 m  05.10.02 



build-in cassette - directional  
Einbaukassette - schwenkbar

**Lamptype**

 QPAR 51 GU10 (1) 50W 230V  
or  QPAR 51 GU10 (1) 11W 230V

**Dimensions**







 H50-70

**Ref cat (CAS)**

- CASVOLTA.ES50.1.1
- CASVOLTA.ES50.1M.40
- CASVOLTA.ES50.2.7
- CASVOLTA.ES50.2.40
- CASVOLTA.ES50.7.7
- CASVOLTA.ES50.7.40
- CASVOLTA.ES50.11.40
- CASVOLTA.ES50.14.40
- CASVOLTA.ES50.18.40
- CASVOLTA.ES50.21.40

cone Ø65xH70  
Kelch Ø65xH70

**CASVOLTA.ES63/.. - SCS SYSTEM**

~230V  IP20    0,1940  1 m  05.10.02 



build-in cassette - directional  
Einbaukassette - schwenkbar

**Lamptype**

 QPAR64 GU10 (1) 75W 230V

**Dimensions**

 H50-70

**Ref cat (CAS)**

- CASVOLTA.ES63.1.1
- CASVOLTA.ES63.1M.40
- CASVOLTA.ES63.2.7
- CASVOLTA.ES63.2.40
- CASVOLTA.ES63.7.7
- CASVOLTA.ES63.7.40
- CASVOLTA.ES63.11.40
- CASVOLTA.ES63.14.40
- CASVOLTA.ES63.18.40
- CASVOLTA.ES63.21.40

cone Ø78xH95  
Kelch Ø78xH95



**CASVOLTA.AR70/.. - SCS SYSTEM**

~12V



build-in cassette - directional - without transformer  
Einbaukassette - schwenkbar - ohne Trafo

**Lamptype**

QR-LP70 BA15d (1) 50W 12V

**Dimensions**

H50-70

**Ref cat (CAS)**

- CASVOLTA.AR70.1.1
- CASVOLTA.AR70.1M.40
- CASVOLTA.AR70.2.7
- CASVOLTA.AR70.2.40
- CASVOLTA.AR70.7.7
- CASVOLTA.AR70.7.40
- CASVOLTA.AR70.11.40
- CASVOLTA.AR70.14.40
- CASVOLTA.AR70.18.40
- CASVOLTA.AR70.21.40

cone Ø78xH95  
Kelch Ø78xH95

**CASCINTO.DICRO/.. - SCS SYSTEM**

~12V



build-in cassette - fixed - without transformer  
Einbaukassette - fest - ohne Trafo

**Lamptype**

QR-CB 51 GU5,3/GX5,3 (1) 50W 12V

**Dimensions**

H90-110

**Ref cat (CAS)**

- CASCINTO.DICRO.1.7
- CASCINTO.DICRO.1M.7
- CASCINTO.DICRO.2.7
- CASCINTO.DICRO.7.7
- CASCINTO.DICRO.11.7
- CASCINTO.DICRO.14.7
- CASCINTO.DICRO.18.7
- CASCINTO.DICRO.21

**CASCINTO.ES50/.. - SCS SYSTEM**

~230V



build-in cassette - fixed  
Einbaukassette - fest

**Lamptype**

QPAR 51 GU10 (1) 50W 230V  
or QPAR 51 GU10 (1) 11W 230V

**Dimensions**

H95-115

**Ref cat (CAS)**

- CASCINTO.ES50.1.7
- CASCINTO.ES50.1M.7
- CASCINTO.ES50.2.7
- CASCINTO.ES50.7.7
- CASCINTO.ES50.11.7
- CASCINTO.ES50.14.7
- CASCINTO.ES50.18.7
- CASCINTO.ES50.21

**CASTINTO.ES50/.. - SCS SYSTEM**

~230V



build-in cassette - fixed  
Einbaukassette - fest

**Lamptype**

QPAR 51 GU10 (1) 50W 230V  
or QPAR 51 GU10 (1) 11W 230V

**Dimensions**

H90-110

**Ref cat (CAS)**

- CASTINTO.ES50.1.7
- CASTINTO.ES50.1M.7
- CASTINTO.ES50.2.7
- CASTINTO.ES50.7.7
- CASTINTO.ES50.11.7
- CASTINTO.ES50.14.7
- CASTINTO.ES50.18.7
- CASTINTO.ES50.21

**CASTINTO.ES63/.. - SCS SYSTEM**

~230V  IP20   0,0900  1 m  05.10.02 



build-in cassette - fixed  
Einbaukassette - fest

**Lamptype**

 QPAR64 GU10 (1) 75W

230V

**Dimensions**

 H90-110

**Ref cat (CAS)**

- CASTINTO.ES63.1.7
- CASTINTO.ES63.1M.7
- CASTINTO.ES63.2.7
- CASTINTO.ES63.7.7
- CASTINTO.ES63.11.7
- CASTINTO.ES63.14.7
- CASTINTO.ES63.18.7
- CASTINTO.ES63.21

**CASTINTO.G9/.. - SCS SYSTEM**

~230V  IP20   0,0975  0,5 m  05.10.02 



build-in cassette - fixed  
Einbaukassette - fest

**Lamptype**

 QT14 G9 (1) 25W

230V

**Dimensions**

 H90-110

**Ref cat (CAS)**

- CASTINTO.G9.1.7
- CASTINTO.G9.1M.7
- CASTINTO.G9.2.7
- CASTINTO.G9.7.7
- CASTINTO.G9.11.7
- CASTINTO.G9.14.7
- CASTINTO.G9.18.7
- CASTINTO.G9.21

**SCOOP/.. - Ø123**

~230V  S1  IP20   0,2250  1 m  05.10.02 



downlight - round - fixed  
Einbaustrahler - rund - fest

**Lamptype**

 QT14 G9 (1) 40W

230V

**Dimensions**

 Ø130xH110

 Ø123  130

**Ref cat (CAS)**

- SCOOP.1
- SCOOP.1M
- SCOOP.11
- SCOOP.40

build-in

**SCOOPC/.. - 95x95**

~230V  S2  IP20   0,2850  1 m  05.10.02 

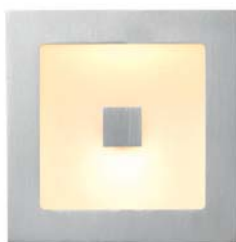

downlight - square - fixed  
Einbaustrahler - viereckig - fest

**Lamptype**

 QT14 G9 (1) 40W

230V

**Dimensions**

 L120xB120xH85

 95x95  105

**Ref cat (CAS)**

- SCOOPC.1
- SCOOPC.1M
- SCOOPC.11
- SCOOPC.40

build-in

SCOOPNODOT/.. - Ø123

~230V



downlight - round - fixed  
Einbaustrahler - rund - fest

Lamptype

QT14 G9 (1) 40W 230V

Dimensions

Ø130xH110  
Ø123 H 130

Ref cat (CAS)

SCOOPNODOT.1M  
SCOOPNODOT.11  
SCOOPNODOT.40

build-in

101H/.. - Ø110 INOX 316

~230V



downlight - round - fixed  
Einbaustrahler - rund - fest

Lamptype

QPAR 30 E27 (1) 75W 230V

Dimensions

Ø130xH155  
Ø110 H 175

Ref cat (CAS)

101H.5  
101H.5B  
101H.5BB  
101H.31  
101H.32  
101H.33

build-in

201/.. - Ø110 INOX 316

~230V



downlight - round - fixed  
Einbaustrahler - rund - fest

Lamptype

QPAR 30 E27 (1) 75W 230V

Dimensions

Ø130xH130  
Ø110 H 150

Ref cat (CAS)

201.5  
201.5B  
201.5BB  
201.31  
201.32  
201.33

build-in

CROSS50/.. - 92x92 INOX 316

~12V

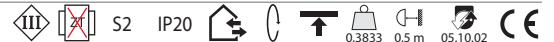

downlight - square - directional - without transformer  
Einbaustrahler - viereckig - schwenkbar - ohne Trafo

Lamptype

QR-CB 51 GU5,3/GX5,3 (1) 50W 12V

Dimensions

L100xB100xH79  
92x92 H 100

Options

S9.92/.. - PLASTERKIT

Ref cat (CAS)

CROSS50.5  
CROSS50.5B  
CROSS50.5BB

build-in

3063/.. - TOLEDO

~230V



build-up ceiling or wall light - round  
Decken- oder Wandleuchte für Aufbau - rund

**Lamptype**

⌀ TC-FSE GX53 (1) 6W

230V

**Dimensions**

↔ Ø82,5xH27

**Ref cat (BAS)**

3063.1

3063.11

3063.14

build-up  
microlynx

3063/..ZA - TOLEDO

~230V



build-up ceiling or wall light - round - sidelong cable connection  
Decken- oder Wandleuchte für Aufbau - rund - lateraler Kabelanschluß

**Lamptype**

⌀ TC-FSE GX53 (1) 6W

230V

**Dimensions**

↔ Ø82,5xH27

**Ref cat (BAS)**

3063.14.ZA

build-up  
microlynx

3064/.. - TOLEDO

~230V



build-up ceiling or wall light - round  
Decken- oder Wandleuchte für Aufbau - rund

**Lamptype**

⌀ TC-FSE GX53 (1) 6W

230V

**Dimensions**

↔ Ø83xH32

**Ref cat (BAS)**

3064.14

build-up  
microlynx

W3064/.. - TOLEDO

~230V



build-up ceiling or wall light - round  
Decken- oder Wandleuchte für Aufbau - rund

**Lamptype**

⌀ TC-FSE GX53 (1) 6W

230V

**Dimensions**

↔ Ø83xH32

**Ref cat (BAS)**

W3064.31

W3064.36

build-up  
microlynx

3061/..B - TOLEDO

~230V  IP20    0.5 m  05.10.02 

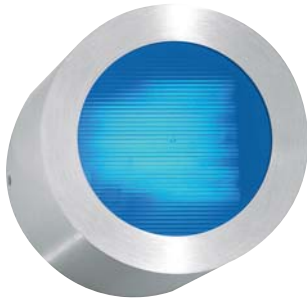

build-up ceiling or wall light - round  
Decken- oder Wandleuchte für Aufbau - rund

Ref cat (BAS)

3061.14.B

Lamptype

⌀ TC-FSE GX53 (1) 6W 230V

Dimensions

↔ Ø100xH45

build-up  
microlynx

3061/..W - TOLEDO

~230V  IP20    0.5 m  05.10.02 



build-up ceiling or wall light - round  
Decken- oder Wandleuchte für Aufbau - rund

Ref cat (BAS)

3061.14.W

Lamptype

⌀ TC-FSE GX53 (1) 6W 230V

Dimensions

↔ Ø100xH45

build-up  
microlynx

W3061/..B - TOLEDO

~230V  IP44    0.5 m  05.10.02 

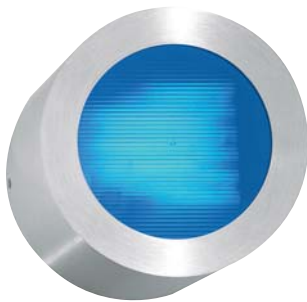

build-up ceiling or wall light - round  
Decken- oder Wandleuchte für Aufbau - rund

Ref cat (BAS)

W3061.36.B

Lamptype

⌀ TC-FSE GX53 (1) 6W 230V

Dimensions

↔ Ø100xH47

Options

2320.230V/.. - TYPE A : LED CASSETTE 230V 3,6W IP65

2320.24V/.. - TYPE B : LED CASSETTE 24V-DC 3,6W IP65

build-up  
microlynx

W3061/..W - TOLEDO

~230V  IP44    0.5 m  05.10.02 



build-up ceiling or wall light - round  
Decken- oder Wandleuchte für Aufbau - rund

Ref cat (BAS)

W3061.36.W

Lamptype

⌀ TC-FSE GX53 (1) 6W 230V

Dimensions

↔ Ø100xH47

Options

2320.230V/.. - TYPE A : LED CASSETTE 230V 3,6W IP65

2320.24V/.. - TYPE B : LED CASSETTE 24V-DC 3,6W IP65

build-up  
microlynx

3065A/.. - TOLEDO

~230V



build-up ceiling or wall light - round  
Decken- oder Wandleuchte für Aufbau - rund

Ref cat (BAS)

3065A.14

Lamptype

⌀ TC-FSE GX53 (1) 6W 230V

Dimensions

↔ Ø89,5xH42

build-up  
microlynx

3065B/.. - TOLEDO

~230V



build-up ceiling or wall light - round  
Decken- oder Wandleuchte für Aufbau - rund

Ref cat (BAS)

3065B.14

Lamptype

⌀ TC-FSE GX53 (1) 6W 230V

Dimensions

↔ Ø89,5xH62

build-up  
microlynx

W3065A/.. - TOLEDO

~230V



build-up ceiling or wall light - round  
Decken- oder Wandleuchte für Aufbau - rund

Ref cat (BAS)

W3065A.36

Lamptype

⌀ TC-FSE GX53 (1) 6W 230V

Dimensions

↔ Ø89,5xH42

build-up  
microlynx

W3065B/.. - TOLEDO

~230V



build-up ceiling or wall light - round  
Decken- oder Wandleuchte für Aufbau - rund

Ref cat (BAS)

W3065B.36

Lamptype

⌀ TC-FSE GX53 (1) 6W 230V

Dimensions

↔ Ø89,5xH62

Options

2320.230V/.. - TYPE A : LED CASSETTE 230V 3,6W IP65

2320.24V/.. - TYPE B : LED CASSETTE 24V-DC 3,6W IP65

build-up  
microlynx

3062/..B - TOLEDO

~230V IP20 0,5 m 05.10.02 CE

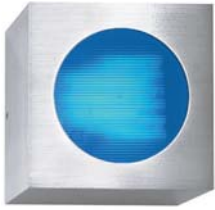

build-up ceiling or wall light - square  
Decken- oder Wandleuchte für Aufbau - viereckig

Ref cat (BAS)

3062.14.B

Lamp type

TC-FSE GX53 (1) 6W 230V

Dimensions

L100xB100xH45

build-up  
microlynx

3062/..W - TOLEDO

~230V IP20 0,5 m 05.10.02 CE



build-up ceiling or wall light - square  
Decken- oder Wandleuchte für Aufbau - viereckig

Ref cat (BAS)

3062.14.W

Lamp type

TC-FSE GX53 (1) 6W 230V

Dimensions

L100xB100xH45

build-up  
microlynx

W3062/..B - TOLEDO

~230V IP44 0,5 m 05.10.02 CE

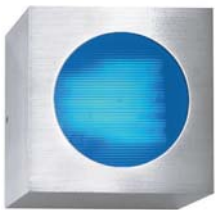

build-up ceiling or wall light - square  
Decken- oder Wandleuchte für Aufbau - viereckig

Ref cat (BAS)

W3062.36.B

Lamp type

TC-FSE GX53 (1) 6W 230V

Dimensions

L100xB100xH47

Options

2320.230V/.. - TYPE A : LED CASSETTE 230V 3,6W IP65  
2320.24V/.. - TYPE B : LED CASSETTE 24V-DC 3,6W IP65

build-up  
microlynx

W3062/..W - TOLEDO

~230V IP44 0,5 m 05.10.02 CE



build-up ceiling or wall light - square  
Decken- oder Wandleuchte für Aufbau - viereckig

Ref cat (BAS)

W3062.36.W

Lamp type

TC-FSE GX53 (1) 6W 230V

Dimensions

L100xB100xH47

Options

2320.230V/.. - TYPE A : LED CASSETTE 230V 3,6W IP65  
2320.24V/.. - TYPE B : LED CASSETTE 24V-DC 3,6W IP65

build-up  
microlynx

3069/.. - TOLEDO

~230V



build-up ceiling or wall light - square  
Decken- oder Wandleuchte für Aufbau - viereckig

Ref cat (BAS)

3069.1

Lamptype

TC-FSE GX53 (1) 6W 230V

3069.14

Dimensions

L100xB100xH45

build-up  
microlynx

W3069/.. - TOLEDO

~230V



build-up ceiling or wall light - square  
Decken- oder Wandleuchte für Aufbau - viereckig

Ref cat (BAS)

W3069.37

Lamptype

TC-FSE GX53 (1) 6W 230V

Dimensions

L100xB100xH47

Options

2320.230V/.. - TYPE A : LED CASSETTE 230V 3,6W IP65  
2320.24V/.. - TYPE B : LED CASSETTE 24V-DC 3,6W IP65

build-up  
microlynx

3079/.. - TOLEDO

~230V



build-up ceiling or wall light - square  
Decken- oder Wandleuchte für Aufbau - viereckig

Ref cat (BAS)

3079.1

Lamptype

TC-FSE GX53 (1) 6W 230V

3079.14

Dimensions

L100xB100xH70

build-up  
microlynx

W3079/.. - TOLEDO

~230V



build-up ceiling or wall light - square  
Decken- oder Wandleuchte für Aufbau - viereckig

Ref cat (BAS)

W3079.37

Lamptype

TC-FSE GX53 (1) 6W 230V

Dimensions

L100xB100xH72

Options

2320.230V/.. - TYPE A : LED CASSETTE 230V 3,6W IP65  
2320.24V/.. - TYPE B : LED CASSETTE 24V-DC 3,6W IP65

build-up  
microlynx



3066/.. - TOLEDO Ø84

~230V



downlight - round  
Einbaustrahler - rund

Ref cat (BAS)

Lamptype

TC-FSE GX53 (1) 6W 230V

3066.1

3066.14

Dimensions

Ø90xH18,5

Ø84 30

Options

S6.87/.. - PLASTERKIT

build-in  
microlynx

3067/.. - TOLEDO Ø84

~230V



downlight - round  
Einbaustrahler - rund

Ref cat (BAS)

Lamptype

TC-FSE GX53 (1) 6W 230V

3067.1

3067.14

Dimensions

Ø90xH28,5

Ø84 40

Options

S6.87/.. - PLASTERKIT

build-in  
microlynx

3060/.. - TOLEDO Ø84

~230V



downlight - round  
Einbaustrahler - rund

Ref cat (BAS)

Lamptype

TC-FSE GX53 (1) 6W 230V

3060.1

3060.14

Dimensions

Ø95xH44,5

Ø84 50

Options

S6.87/.. - PLASTERKIT

build-in  
microlynx

3074/.. - TOLEDO Ø84

~230V



downlight - square  
Einbaustrahler - viereckig

Ref cat (BAS)

Lamptype

TC-FSE GX53 (1) 6W 230V

3074.1

3074.14

Dimensions

L92xB92xH18,5

Ø84 30

Options

S6.87/.. - PLASTERKIT

build-in  
microlynx

3075/.. - TOLEDO Ø84

~230V



S2 IP20



downlight - square  
Einbaustrahler - viereckig

**Lamptype**

TC-FSE GX53 (1) 6W 230V

**Dimensions**

L92xB92xH28,5

Ø84 H 40

**Options**

S6.87/.. - PLASTERKIT

**Ref cat (BAS)**

3075.1

3075.14

build-in  
microlynx

3068/.. - TOLEDO Ø84

~230V



S3 IP20



downlight - round  
Einbaustrahler - rund

**Lamptype**

TC-FSE GX53 (1) 6W 230V

**Dimensions**

Ø105xH51

Ø84 H 70

**Options**

S6.87/.. - PLASTERKIT

**Ref cat (BAS)**

3068.1

3068.14

semi build in/up  
microlynx

W3068/.. - TOLEDO Ø84

~230V



S3 IP44



downlight - round  
Einbaustrahler - rund

**Lamptype**

TC-FSE GX53 (1) 6W 230V

**Dimensions**

Ø105xH51

Ø84 H 60

**Options**

2320.230V/.. - TYPE A : LED CASSETTE 230V 3,6W IP65

2320.24V/.. - TYPE B : LED CASSETTE 24V-DC 3,6W IP65

S6.87/.. - PLASTERKIT

**Ref cat (BAS)**

W3068.36

semi build in/up  
microlynx

2320.230V/.. - TYPE A : LED CASSETTE 230V 3,6W IP65

~230V  IP65    



accessories for garden lighting - fixed - not dimmable  
Zubehör für Gartenleuchten - fest - nicht dimmbar

Ref  
2320.230V.NW



**Lamptype**  
 led 230V . (1) 3,6W 230V

**Dimensions**  
 Ø70

**Options**  
LAVA-ETNA LED  
TOLEDO FLOOR OR WALL

Niko-Erea LED - NW 4000K

2320.24V/.. - TYPE B : LED CASSETTE 24V-DC 3,6W IP65

=24V-DC   IP65    



accessories for garden lighting - fixed - not dimmable -  
without transformer  
Zubehör für Gartenleuchten - fest - nicht dimmbar - ohne  
Trafo

Ref  
2320.24V.NW

**Lamptype**  
 led 24V-DC . (1) 3,6W 24V-DC

**Dimensions**  
 Ø70

**Options**  
LAVA-ETNA LED  
TOLEDO FLOOR OR WALL

Niko-Erea LED - NW 4000K - parallel connection  
Parallelschaltung





**INDOOR | Accessories ADAPTOR**

**CONNECTOR**



**KNEEJOINT**



**JACK**



**ROSETTE TO BUILD IN**

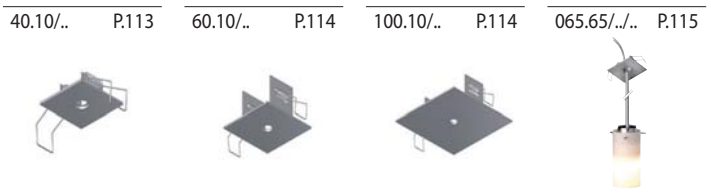
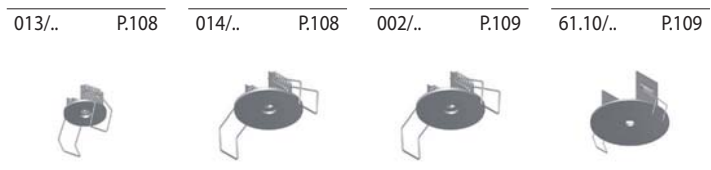

**ROSETTE TO BUILD UP**



**ROSETTE TO BUILD UP**

025/.. P.119    017/.. P.119    027/.. P.120    026/.. P.120    025.B3/./.. P.120    026.B3/./.. P.121

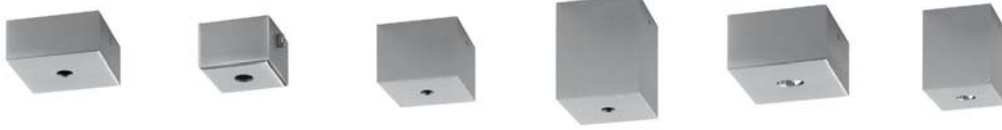

651/.. P.121    032/.. P.121    028/.. P.122    006/.. P.122



007/.. P.122    008/.. P.123    012/.. P.123    016/.. P.123



CONNECTOR FOR TRACKS	106
JACK	107
KNEEJOINT	107,108
ROSETTE TO BUILD IN	108 - 116
ROSETTE TO BUILD UP	116 - 122
ROSETTE - M12	117
TEXO - M10	121
TRANSFORMER BOX	122, 123

024/.. - CONNECTOR FOR TRACKS

IP20     0,0249 



accessories for build-up spot or pendant - for monorail  
M10x1 - M8x0,75 (12V-230V)  
Zubehör für Aufbauleuchte oder Pendelleuchte - für Monorail  
M10x1 - M8x0,75 (12V-230V)

Ref

- 024.1
- 024.1M
- 024.2
- 024.4
- 024.7
- 024.11
- 024.13
- 024.14
- 024.16

023.M6/.. - CONNECTOR FOR TRACKS - M6

III  IP20     0,0100 



accessories for build-up spot or pendant - M10 - M6x1 (12V)  
Zubehör für Aufbauleuchte oder Pendelleuchte - M10 - M6x1  
(12V)

Ref

- 023.M6.1
- 023.M6.2
- 023.M6.4
- 023.M6.7
- 023.M6.11
- 023.M6.13
- 023.M6.14
- 023.M6.16

023.M10/.. - CONNECTOR FOR TRACKS - M10

III  IP20     0,0100 



accessories for build-up spot or pendant - M10 - M8x0,75  
(12V)  
Zubehör für Aufbauleuchte oder Pendelleuchte - M10 -  
M8x0,75 (12V)

Ref

- 023.M10.1
- 023.M10.2
- 023.M10.4
- 023.M10.7
- 023.M10.11
- 023.M10.13
- 023.M10.14
- 023.M10.16

4000/.. - ADAPTOR

III  IP20     0,0260 

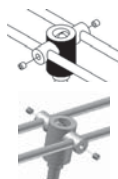

supplement - adaptor for spots on tracks 12V  
Supplement - Adapter für Spots auf Schiene 12V

Ref

- 4000.4
- 4000.7

018/.. - JACK



jack - 12V  
Jack - 12V

Ref

- 018.1
- 018.2
- 018.4
- 018.7
- 018.11
- 018.13
- 018.14
- 018.16

supplement article step - domino - discuss - capri - jazz  
- cocktail - colibri  
Supplement für step - domino - discuss - capri - jazz -  
cocktail - colibri

010/.. - JACK



jack - build-in base for jack  
Jack - Einbaurosette für Jack

Dimensions

→ Ø45xH48  
→ Ø18-19 √L 48

Options

018/.. - JACK  
STEP - DISCUS - CAPRI - DOMINO - JAZZ

Ref

- 010.1
- 010.2
- 010.4
- 010.7
- 010.11
- 010.13
- 010.14
- 010.16

build-in  
12V only  
nur 12V

011/.. - JACK



jack - build-up base for jack  
Jack - Aufbaurosette für Jack

Dimensions

→ Ø60xH40

Options

018/.. - JACK  
STEP - DISCUS - CAPRI - DOMINO - JAZZ

Ref

- 011.1
- 011.2
- 011.4
- 011.7
- 011.11
- 011.13
- 011.14
- 011.16

build-up  
12V only  
nur 12V

015/./.. - KNEEJOINT - M6 -M8 -M10



accessories for build-up spot - 12V  
Zubehör für Aufbaustrahler - 12V

Ref

- 015/...1
- 015/...2
- 015/...4
- 015/...7
- 015/...11
- 015/...13
- 015/...16

12V only  
nur 12V

022/.. - KNEEJOINT

IP20    0,0179 



accessories for build-up spot - 230V  
Zubehör für Aufbaustrahler - 230V

Ref

- 022.1
- 022.2
- 022.4
- 022.7
- 022.11
- 022.13
- 022.16

12V-230V

019/.. - KNEEJOINT

IP20    0,0350 



accessories for build-up spot - M10 - M8x0,75 + stop  
12V-230V  
Zubehör für Aufbaustrahler - M10 - M8x0,75 + Stopp  
12V-230V

Ref

- 019.4
- 019.7
- 019.13
- 019.14
- 019.16

12V-230V

013/.. - ROSETTE - M10

 S1 IP20    0,0185 



rosette to build in - round  
Einbaurosette - rund

Dimensions

 Ø33

 Ø30  45

Ref

- 013.1
- 013.1M
- 013.2
- 013.4
- 013.5
- 013.7
- 013.11
- 013.13
- 013.14
- 013.16

build-in

014/.. - ROSETTE - M10

 S1 IP20    0,0215 



rosette to build in - round  
Einbaurosette - rund

Dimensions

 Ø43

 Ø39-40  45

Ref

- 014.1
- 014.1M
- 014.2
- 014.4
- 014.5
- 014.7
- 014.11
- 014.13
- 014.14
- 014.16

build-in



002/.. - ROSETTE - M10



III S1 IP20    0,0275 



rosette to build in - round  
Einbaurosette - rund

Dimensions

 Ø50

 Ø35-40  45

Ref

- 002.1
- 002.1M
- 002.2
- 002.4
- 002.5
- 002.7
- 002.11
- 002.13
- 002.14
- 002.16

build-in

61.10/.. - ROSETTE - M10

III S1 IP20    0,0416 



rosette to build in - round  
Einbaurosette - rund

Dimensions

 Ø60

 Ø40  55

Ref

- 61.10.1
- 61.10.1M
- 61.10.2
- 61.10.4
- 61.10.7
- 61.10.11
- 61.10.13
- 61.10.14
- 61.10.16

build-in

81.10/.. - ROSETTE - M10

III S1 IP20    0,0950 



rosette to build in - round  
Einbaurosette - rund

Dimensions

 Ø80

 Ø60  55

Ref

- 81.10.1
- 81.10.1M
- 81.10.2
- 81.10.4
- 81.10.5
- 81.10.7
- 81.10.11
- 81.10.13
- 81.10.14
- 81.10.16

build-in

101.10/.. - ROSETTE - M10

III S1 IP20    0,1390 



rosette to build in - round  
Einbaurosette - rund

Dimensions

 Ø100

 Ø80  55

Ref

- 101.10.1
- 101.10.1M
- 101.10.2
- 101.10.4
- 101.10.5
- 101.10.7
- 101.10.11
- 101.10.13
- 101.10.14
- 101.10.16

build-in

121.10/.. - ROSETTE - M10

III S1 IP20    0,1830 



rosette to build in - round  
Einbaurosette - rund

Dimensions

 Ø120

 Ø100  55

Ref

121.10.1  
121.10.1M  
121.10.2  
121.10.4  
121.10.5  
121.10.7  
121.10.11  
121.10.13  
121.10.14  
121.10.16

build-in

141.10/.. - ROSETTE - M10

III S1 IP20    0,2385 



rosette to build in - round  
Einbaurosette - rund

Dimensions

 Ø140

 Ø120  55

Ref

141.10.1  
141.10.1M  
141.10.2  
141.10.4  
141.10.5  
141.10.7  
141.10.11  
141.10.13  
141.10.14  
141.10.16

build-in

161.10/.. - ROSETTE - M10

III S1 IP20    0,3025 



rosette to build in - round  
Einbaurosette - rund

Dimensions

 Ø160

 Ø140  55

Ref

161.10.1  
161.10.1M  
161.10.2  
161.10.4  
161.10.5  
161.10.7  
161.10.11  
161.10.13  
161.10.14  
161.10.16

build-in

181.10/.. - ROSETTE - M10

III S1 IP20    0,3690 



rosette to build in - round  
Einbaurosette - rund

Dimensions

 Ø180

 Ø160  55

Ref

181.10.1  
181.10.1M  
181.10.2  
181.10.4  
181.10.5  
181.10.7  
181.10.11  
181.10.13  
181.10.14  
181.10.16

build-in

065/./.. - ROSETTE M6-M8-M10-D8,3



rosette to build in - round - with swivel B3  
Einbaurosette - rund - mit Kugelgelenk B3

Dimensions

↔ Ø65

📏 Ø42-45 ⚙️ 55

Colour	065.D8,3/..	065.M10/..	065.M6/..	065.M8/..
1				
1M				
2				
4				
7				
11				
13				
14				
16				

**build-in**  
for pendants only - not for spots  
nur für Hängeleuchte - nicht für Aufbaustrahler

080/./.. - ROSETTE M6-M8-M10-D8,3



rosette to build in - round - with swivel B3  
Einbaurosette - rund - mit Kugelgelenk B3

Dimensions

↔ Ø80

📏 Ø42-60 ⚙️ 55

Colour	080.D8,3/..	080.M10/..	080.M6/..	080.M8/..
1				
1M				
2				
4				
7				
11				
13				
14				
16				

**build-in**  
for pendants only - not for spots  
nur für Hängeleuchte - nicht für Aufbaustrahler



100./../.. - ROSETTE

III S1 IP20 0,1450



rosette to build in - round - with swivel B3  
Einbaurosette - rund - mit Kugelgelenk B3

Dimensions

→ Ø100

↙ Ø80 ↘ 55

Colour	100.D8,3/..	100.M10/..	100.M6/..	100.M8/..
1				
1M				
2				
4				
7				
11				
13				
14				
16				

for pendants only - not for spots  
nur für Hängeleuchte - nicht für Aufbaustrahler

102.10./.. - ROSETTE - M10

III S1 IP20 0,1385



rosette to build in - round  
Einbaurosette - rund

Dimensions

→ Ø100

↙ Ø80 ↘ 55

Ref

- 102.10.1
- 102.10.1M
- 102.10.2
- 102.10.4
- 102.10.5
- 102.10.7
- 102.10.11
- 102.10.13
- 102.10.14
- 102.10.16

build-in

122.10./.. - ROSETTE - M10

III S1 IP20 0,1770



rosette to build in - round  
Einbaurosette - rund

Dimensions

→ Ø120

↙ Ø100 ↘ 55

Ref

- 122.10.1
- 122.10.1M
- 122.10.2
- 122.10.4
- 122.10.5
- 122.10.7
- 122.10.11
- 122.10.13
- 122.10.14
- 122.10.16

build-in

142.10/.. - ROSETTE - M10

III S1 IP20    0,2375 



rosette to build in - round  
Einbaurosette - rund

Dimensions

 Ø140

 Ø120  55

Ref

- 142.10.1
- 142.10.1M
- 142.10.2
- 142.10.4
- 142.10.5
- 142.10.7
- 142.10.11
- 142.10.13
- 142.10.14
- 142.10.16

build-in

162.10/.. - ROSETTE - M10

III S1 IP20    0,2865 



rosette to build in - round  
Einbaurosette - rund

Dimensions

 Ø160

 Ø140  55

Ref

- 162.10.1
- 162.10.1M
- 162.10.2
- 162.10.4
- 162.10.5
- 162.10.7
- 162.10.11
- 162.10.13
- 162.10.14
- 162.10.16

build-in

182.10/.. - ROSETTE - M10

III S1 IP20    0,3030 



rosette to build in - round  
Einbaurosette - rund

Dimensions

 Ø180

 Ø160  55

Ref

- 182.10.1
- 182.10.1M
- 182.10.2
- 182.10.4
- 182.10.5
- 182.10.7
- 182.10.11
- 182.10.13
- 182.10.14
- 182.10.16

build-in

40.10/.. - ROSETTE - M10



III S1 IP20    0,0255 



rosette to build in - square  
Einbaurosette - viereckig

Dimensions

 L40xB40

 Ø30  55

Ref

- 40.10.1
- 40.10.1M
- 40.10.2
- 40.10.4
- 40.10.5
- 40.10.7
- 40.10.11
- 40.10.13
- 40.10.14
- 40.10.16

build-in

50.10/.. - ROSETTE - M10

III S1 IP20    0,0370 

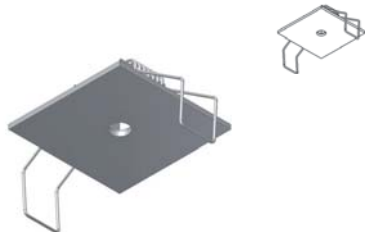

rosette to build in - square  
Einbaurosette - viereckig

Dimensions

 L50xB50

 Ø30  55

Ref

- 50.10.1
- 50.10.1M
- 50.10.2
- 50.10.4
- 50.10.7
- 50.10.11
- 50.10.13
- 50.10.14
- 50.10.16

build-in

60.10/.. - ROSETTE - M10

III S1 IP20    0,0437 

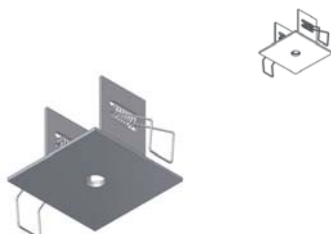

rosette to build in - square  
Einbaurosette - viereckig

Dimensions

 L60xB60

 Ø39-40  55

Ref

- 60.10.1
- 60.10.1M
- 60.10.2
- 60.10.4
- 60.10.5
- 60.10.7
- 60.10.11
- 60.10.13
- 60.10.14
- 60.10.16

build-in

80.10/.. - ROSETTE - M10

III S1 IP20    0,0995 



rosette to build in - square  
Einbaurosette - viereckig

Dimensions

 L80xB80

 Ø60  55

Ref

- 80.10.1
- 80.10.1M
- 80.10.2
- 80.10.4
- 80.10.5
- 80.10.7
- 80.10.11
- 80.10.13
- 80.10.14
- 80.10.16

build-in

100.10/.. - ROSETTE - M10

III S1 IP20    0,1353 

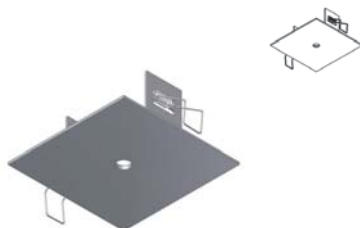

rosette to build in - square  
Einbaurosette - viereckig

Dimensions

 L100xB100

 Ø80  55

Ref

- 100.10.1
- 100.10.1M
- 100.10.2
- 100.10.4
- 100.10.5
- 100.10.7
- 100.10.11
- 100.10.13
- 100.10.14
- 100.10.16

build-in

065.65/./.. - ROSETTE M6-M8-M10-D8,3



rosette to build in - square - with swivel B3  
Einbaurosette - viereckig - mit Kugelgelenk B3

Dimensions

↔ L65xB65

📏 Ø42-45 ⚙️ 55

Colour	065.65. D8,3/..	065.65. M10/..	065.65. M6/..	065.65. M8/..
1				
1M				
2				
4				
7				
11				
13				
14				
16				

**build-in**  
for pendants only - not for spots  
nur für Hängeleuchte - nicht für Aufbaustrahler

080.80/./.. - ROSETTE M6-M8-M10-D8,3



rosette to build in - square - with swivel B3  
Einbaurosette - viereckig - mit Kugelgelenk B3

Dimensions

↔ L80xB80

📏 Ø42-60 ⚙️ 55

Colour	080.80. D8,3/..	080.80. M10/..	080.80. M6/..	080.80. M8/..
1				
1M				
2				
4				
7				
11				
13				
14				
16				

**build-in**  
for pendants only - not for spots  
nur für Hängeleuchte - nicht für Aufbaustrahler



100.100/././.. - ROSETTE



rosette to build in - square - with swivel B3  
Einbaurosette - viereckig - mit Kugelgelenk B3

Dimensions

↔ L100xB100

⌀80 ⌊ 55

Colour	100.100. D8,3/..	100.100. M10/..	100.100. M6/..	100.100. M8/..
1				
1M				
2				
4				
7				
11				
13				
14				
16				

for pendants only - not for spots  
nur für Hängeleuchte - nicht für Aufbaustrahler

001/.. - ROSETTE - M10



build-up rosette - round - without transformer  
Aufbaurosette - rund - ohne Trafo

Dimensions

↔ Ø55xH22

Ref

- 001.1
- 001.1M
- 001.2
- 001.4
- 001.7
- 001.11
- 001.13
- 001.16

build-up

003/.. - ROSETTE - M10



build-up rosette - round - without transformer  
Aufbaurosette - rund - ohne Trafo

Dimensions

↔ Ø55xH22

Ref

- 003.1
- 003.1M
- 003.2
- 003.4
- 003.7
- 003.11
- 003.13
- 003.14
- 003.16

build-up





004/.. - ROSETTE - M10



build-up rosette - round - without transformer  
Aufbaurosette - rund - ohne Trafo

Dimensions

↔ Ø60xH24

Ref

- 004.1
- 004.1M
- 004.2
- 004.4
- 004.7
- 004.11
- 004.13
- 004.14
- 004.16

build-up

005/.. - ROSETTE - M10



build-up rosette - round - without transformer  
Aufbaurosette - rund - ohne Trafo

Dimensions

↔ Ø60xH25

Ref

- 005.1
- 005.1M
- 005.2
- 005.4
- 005.7
- 005.11
- 005.13
- 005.14
- 005.16
- 005.23

build-up

2025/.. - ROSETTE - M10



build-up rosette - round - without transformer  
Aufbaurosette - rund - ohne Trafo

Dimensions

↔ Ø60xH40

Ref

- 2025.1
- 2025.1M
- 2025.2
- 2025.4
- 2025.7
- 2025.10
- 2025.11
- 2025.13
- 2025.14
- 2025.16
- 2025.23

build-up

2024/.. - ROSETTE - M12



build-up rosette - round - without transformer  
Aufbaurosette - rund - ohne Trafo

Dimensions

↔ Ø60xH68

Ref

- 2024.1
- 2024.1M
- 2024.2
- 2024.10
- 2024.11

build-up  
only for profiles  
nur für Profile

020/.. - ROSETTE - M10



build-up rosette - round - without transformer  
Aufbaurosette - rund - ohne Trafo

Dimensions

↔ Ø54xH40

Ref

- 020.1
- 020.1M
- 020.2
- 020.4
- 020.7
- 020.11
- 020.13
- 020.14
- 020.16

build-up

021/.. - ROSETTE - M10



build-up rosette - round - with transformer  
Aufbaurosette - rund - mit Trafo

Dimensions

↔ Ø60xH65

Ref

- 021.1
- 021.1M
- 021.2
- 021.4
- 021.7
- 021.11
- 021.13
- 021.14
- 021.16

build-up  
60VA

020.B3/./... - ROSETTE -M10-M8-M6-D8,3



build-up rosette - round - with swivel B3 - without transformer  
Aufbaurosette - rund - mit Kugelgelenk B3 - ohne Trafo

Dimensions

↔ Ø54xH60

Colour	020. B3.D8,3/..	020. B3.M10/..	020. B3.M6/..	020. B3.M8/..
1				
1M				
2				
4				
7				
11				
13				
14				
16				

build-up  
for pendants only - not for spots  
nur für Hängeleuchte - nicht für Aufbaustrahler

021.B3/./.. - ROSETTE-M10-M8-M6-D8,3



build-up rosette - round - with swivel B3 - with transformer  
 Aufbaurosette - rund - mit Kugelgelenk B3 - mit Trafo

Dimensions

↔ Ø60xH90

Colour	021. B3.D8,3/..	021. B3.M10/..	021. B3.M6/..	021. B3.M8/..
1				
1M				
2				
4				
7				
11				
13				
14				
16				

build-up  
 60VA - for pendants only - not for spots  
 nur für Hängeleuchte - nicht für Aufbaustrahler

025/.. - ROSETTE - M10



build-up rosette - square - without transformer  
 Aufbaurosette - viereckig - ohne Trafo

Dimensions

↔ L60xB60xH25

Ref

- 025.1
- 025.1M
- 025.2
- 025.4
- 025.7
- 025.11
- 025.13
- 025.14
- 025.16

build-up

017/.. - ROSETTE - M10



build-up rosette - without transformer  
 Aufbaurosette - ohne Trafo

Dimensions

↔ L40xB40xH25

Ref

- 017.1
- 017.1M
- 017.2
- 017.4
- 017.7
- 017.11
- 017.13
- 017.14
- 017.16

build-up

027/.. - ROSETTE - M10



build-up rosette - square - without transformer  
 Aufbaurosette - viereckig - ohne Trafo

**Dimensions**

↔ L60xB60xH40

**Ref**

- 027.1
- 027.1M
- 027.2
- 027.4
- 027.7
- 027.11
- 027.13
- 027.14
- 027.16

build-up

026/.. - ROSETTE - M10



build-up rosette - square - with transformer  
 Aufbaurosette - viereckig - mit Trafo

**Dimensions**

↔ L60xB60xH65

**Ref**

- 026.1
- 026.1M
- 026.2
- 026.4
- 026.7
- 026.11
- 026.13
- 026.14
- 026.16

build-up  
 60VA

025.B3/... - ROSETTE-M10-M8-M6-D8,3



build-up rosette - square - with swivel B3 - without transformer  
 Aufbaurosette - viereckig - mit Kugelgelenk B3 - ohne Trafo

**Dimensions**

↔ L60xB60xH40

Colour	025. B3.D8,3/..	025. B3.M10/..	025. B3.M6/..	025. B3.M8/..
1				
1M				
2				
4				
7				
11				
13				
14				
16				

build-up  
 for pendants only - not for spots  
 nur für Hängeleuchte - nicht für Aufbaustrahler

026.B3/./.. - ROSETTE-M10-M8-M6-D8,3



build-up rosette - square - with swivel B3 - with transformer  
 Aufbaurosette - viereckig - mit Kugelgelenk B3 - mit Trafo

Dimensions

↔ L60xB60xH65

Colour	026. B3.D8,3/..	026. B3.M10/..	026. B3.M6/..	026. B3.M8/..
1				
1M				
2				
4				
7				
11				
13				
14				
16				

**build-up**  
 60VA - for pendants only - not for spots  
 nur für Hängeleuchte - nicht für Aufbaustrahler

651/.. - TEXO - M10



build-up rosette - no room for transformer  
 Aufbaurosette - kein Platz für Trafo

Dimensions

↔ L85xB85xH30

↗ L60xB60

Ref

- 651.1
- 651.1M
- 651.2
- 651.4
- 651.5
- 651.7
- 651.11
- 651.13
- 651.14
- 651.16

**build-up**  
 230V - spot to be ordered separately  
 Strahler separat zu bestellen

032/.. - ROSETTE - M10



build-up rosette - for pendant  
 Aufbaurosette - für Pendelleuchte

Dimensions

↔ Ø100xH32

↗ Ø80

Ref

- 032.1
- 032.1M
- 032.4
- 032.7
- 032.11
- 032.13
- 032.14
- 032.16

**build-up**

028/.. - ROSETTE - M10



build-up rosette - without transformer  
Aufbaurosette - ohne Trafo

Dimensions

↔ L115xB32xH27

Ref

- 028.1
- 028.1M
- 028.2
- 028.4
- 028.7
- 028.11
- 028.13
- 028.14
- 028.16

build-up

006/.. - TRANSFORMER BOX



transformer box - empty - without transformer  
Trafogehäuse - leer - ohne Trafo

Dimensions

↔ L90xB39xH90

Ref

- 006.1
- 006.1M
- 006.2
- 006.4
- 006.7
- 006.11
- 006.13
- 006.14
- 006.16

build-up

006/..T - TRANSFORMER BOX - M10



transformer box - with transformer  
Trafogehäuse - mit Trafo

Dimensions

↔ L90xB39xH90

Ref

- 006.1.T
- 006.1M.T
- 006.2.T
- 006.4.T
- 006.7.T
- 006.11.T
- 006.13.T
- 006.14.T
- 006.16.T

build-up  
60VA

007/.. - TRANSFORMER BOX



transformer box - empty for monorail 12V - without transformer  
Trafogehäuse - leer für Monorail 12V - ohne Trafo

Dimensions

↔ L210xB95xH40

Ref

- 007.1
- 007.1M
- 007.2
- 007.4
- 007.7
- 007.11
- 007.13
- 007.16

build-up

008/.. - TRANSFORMER BOX



transformer box - empty - without transformer  
Trafogehäuse - leer - ohne Trafo

Dimensions

↔ L240xB75xH70

Ref

- 008.1
- 008.1M
- 008.2
- 008.4
- 008.7
- 008.11
- 008.14
- 008.16

build-up

012/.. - TRANSFORMER BOX



transformer box - empty - without transformer  
Trafogehäuse - leer - ohne Trafo

Dimensions

↔ L230xB75xH60

Ref

- 012.1
- 012.1M
- 012.2
- 012.4
- 012.7
- 012.11
- 012.13
- 012.14
- 012.16

build-up

016/.. - TRANSFORMER BOX



transformer box - empty - without transformer  
Trafogehäuse - leer - ohne Trafo

Dimensions

↔ L440xB75xH58

Ref

- 016.1
- 016.1M
- 016.2
- 016.4
- 016.7
- 016.11
- 016.13
- 016.14
- 016.16

build-up

**PIVA**

3999.G9/.. P.141



**FLEX**

4001.G4/.. P.143



4002/./.. P.152



GL423S/.. P.150



GL5434WN/.. P.151



GL1135S/.. P.151



**TUBA**

4003/.. P.152



**LUNA**

4004/.. P.153



**MAX**

4025/.. P.154



**GUILIA**

4026/.. P.155



4028/.. P.156



**SPAZIO**

3071.G9/.. P.163



**NOA**

4013/.. P.157



4014/.. P.158



4015/.. P.159



APOLLO	134,138
CAPRI	130,138
COCTAIL	126
COLIBRI	127
COMMA	135, 136
CONDOR	130
CRICKET	135
CUBIC	134,140
DISCOVERY	128
DISCUS	131,137,139
DOMINO	129
FLEX	152
FOLIO	132
GLASS	142 -152
GL423S/..	150
GLOBO	133
GUILIA	155,156
JAZZ	126
JUPITER	131
LUNA	153,154
MAX	154
NOA	159 -162
ORKA	141
PIVA	141 -143
SATURNO	134,138
SPAZIO	163
STEP	129,137,139
TUBA	127,152
TWIST	135
UTOPIE	133
VIOLA	128





**JAZZ**

90../.. P.126



**COCTAIL**

70../.. P.126



**COLIBRI**

80../.. P.127



**TUBA**

50../.. P.127



**VOLTA**

1956.10../.. P.132



**VOLTA**

1956../.. P.132



**STEP**

63../.. P.129



**JUPITER**

68../.. P.131



**HI STEP**

HI.63../.. P.137



**STEP LED**

L.63../.. P.139



**FOLIO**

64../.. P.132



**UTOPIE**

62../.. P.133



**DOMINO**

61../.. P.129



**CAPRI**

71../.. P.130



**HI CAPRI**

HI.71../.. P.138



**CONDOR**

72../.. P.130



**APOLLO**

66../.. P.134



**SATURNO**

67../.. P.134



**DISCUS**

60../.. P.131



**DISCOVERY**

69../.. P.128



**VIOLA**

1960../.. P.128



**DISCUS LED**

L.60../.. P.139



**HI DISCUS**

HI.60../.. P.137



**GLOBO**

1809../.. P.133



**COMMA**

3004.DISCUS../.. P.136



3004.JUPITER../.. P.136



3004.STEP../.. P.136



3005.DISCUS../.. P.136



3005.JUPITER../.. P.136



3005.STEP../.. P.136



**CUBIC**

74.65../.. P.134



74.100../.. P.134



74LED.65../.. P.140



74LED.100../.. P.140



**ORKA**

3023../.. P.141



**CRICKET**

1288../.. P.135



**TWIST**

6500../.. P.135



## INDOOR | Spots & pendants | JAZZ 12V - M10 | COCTAIL 12V - M10

All M10 spotlights and pendants can be combined with bases (build-in & build-up) and Juba bases as preferred.  
 Alle M10 Aufbaustrahler und Pendelleuchten können mit Rosetten (In- & Aufbau) und Juba Basen nach Wahl kombiniert werden.

### 90../.. - JAZZ 12V - M10

~12V   IP20    0,1250  0,5 m  05.10.02 



build-up spot M10 - without transformer  
 Aufbaustrahler M10 - ohne Trafo

#### Lamp type

◁ QR-CB 51 GU5,3/GX5,3 (1) 50W 12V

Colour	9005/..	9010/..	9015/..	9020/..	9030/..
	H 50	H 100	H 150	H 200	H 300
1					
2					
4					
7					
11					
13					
16					

### 70../.. - COCTAIL 12V - M10

~12V   IP20    0,1250  0,5 m  05.10.02 



build-up spot M10 - without transformer  
 Aufbaustrahler M10 - ohne Trafo

#### Lamp type

◁ QR-CB 51 GU5,3/GX5,3 (1) 50W 12V

Colour	7005/..	7010/..	7015/..	7020/..	7030/..
	H 50	H 100	H 150	H 200	H 300
1					
2					
4					
7					
11					
13					
16					

# INDOOR | Spots & pendants | COLIBRI 12V -M10 | TUBA 12V - M10

All M10 spotlights and pendants can be combined with bases (build-in & build-up) and Juba bases as preferred.  
 Alle M10 Aufbaustrahler und Pendelleuchten können mit Rosetten (In- & Aufbau) und Juba Basen nach Wahl kombiniert werden.

## 80../.. - COLIBRI 12V -M10

~12V



build-up spot M10 - without transformer  
 Aufbaustrahler M10 - ohne Trafo

### Lamptype

QR-CB 51 GU5,3/GX5,3 (1) 50W 12V

Colour	8005/..	8010/..	8015/..	8020/..	8030/..
	H 50	H 100	H 150	H 200	H 300
1					
2					
4					
7					
11					
13					
16					

## 50../.. - TUBA 12V - M10

~12V



build-up spot M10 - without transformer  
 Aufbaustrahler M10 - ohne Trafo

### Lamptype

QR-CB 51 coolfit GU5,3/GX5,3 (1) 35W 12V

Colour	5010/..	5020/..	5030/..
	H 100	H 200	H 300
1			
2			
4			
7			
11			
13			
14			
16			

use coolfit lamp  
 Coolfit-Lampe verwenden

# INDOOR | Spots & pendants | DISCOVERY 12V - M10 | VIOLA 12V - M10

All M10 spotlights and pendants can be combined with bases (build-in & build-up) and Juba bases as preferred.  
 Alle M10 Aufbaustrahler und Pendelleuchten können mit Rosetten (In- & Aufbau) und Juba Basen nach Wahl kombiniert werden.

## 69../.. - DISCOVERY 12V - M10

~12V



build-up spot M10 - without transformer  
 Aufbaustrahler M10 - ohne Trafo

### Lamptype

QR-CB 51 coolfit GU5,3/GX5,3 (1) 35W 12V

Colour	6905/..	6910/..	6915/..	6920/..	6930/..
	H 50	H 100	H 150	H 200	H 300
1					
2					
4					
7					
11					
13					
14					
16					

use coolfit lamp  
 Coolfit-Lampe verwenden

## 1960../.. - VIOLA 12V - M10

~12V



build-up spot M10 - without transformer  
 Aufbaustrahler M10 - ohne Trafo

### Lamptype

QR-CB 51 GU5,3/GX5,3 (1) 50W 12V

Colour	1960.10/..	1960.15/..	1960.20/..	1960.30/..
	H 100	H 150	H 200	H 300
14				

# INDOOR | Spots & pendants | STEP 12V - M10 | DOMINO 12V- M10

All M10 spotlights and pendants can be combined with bases (build-in & build-up) and Juba bases as preferred.  
 Alle M10 Aufbaustrahler und Pendelleuchten können mit Rosetten (In- & Aufbau) und Juba Basen nach Wahl kombiniert werden.

## 63../.. - STEP 12V - M10

~12V 0,1600 0,5 m 05.10.02



build-up spot M10 - without transformer  
 Aufbaustrahler M10 - ohne Trafo

### Lamptype

◁ QR-CB 51 GU5,3/GX5,3 (1) 50W 12V

Colour	6305/..	6310/..	6315/..	6320/..	6330/..	6350/..	6380/..
	H 70	H 100	H 150	H 200	H 300	H 500	H 800
1							
2							
4							
7							
11							
13							
14							
16							
23							

## 61../.. - DOMINO 12V- M10

~12V 0,2850 0,5 m 05.10.02



build-up spot M10 - without transformer  
 Aufbaustrahler M10 - ohne Trafo

### Lamptype

◁ QR-CB 51 GU5,3/GX5,3 (1) 50W 12V

Colour	6105/..	6110/..	6115/..	6120/..	6130/..	6150/..	6180/..
	H 70	H 100	H 150	H 200	H 300	H 500	H 800
1							
2							
4							
7							
11							
13							
14							
16							

# INDOOR | Spots & pendants | CAPRI 12V -M10 | CONDOR 12V -M10

All M10 spotlights and pendants can be combined with bases (build-in & build-up) and Juba bases as preferred.  
 Alle M10 Aufbaustrahler und Pendelleuchten können mit Rosetten (In- & Aufbau) und Juba Basen nach Wahl kombiniert werden.

## 71../.. - CAPRI 12V -M10

~12V



build-up spot M10 - without transformer  
 Aufbaustrahler M10 - ohne Trafo

### Lamp type

◁ QR-CB 51 GU5,3/GX5,3 (1) 50W 12V

Colour	7105/..	7110/..	7115/..	7120/..	7130/..
	H 70	H 100	H 150	H 200	H 300
1					
2					
4					
7					
11					
13					
14					
16					

## 72../.. - CONDOR 12V -M10

~12V



build-up spot M10 - without transformer  
 Aufbaustrahler M10 - ohne Trafo

### Lamp type

◁ QR-CB 51 GU5,3/GX5,3 (1) 50W 12V

Colour	7205/..	7210/..	7215/..	7220/..	7230/..
	H 70	H 100	H 150	H 200	H 300
1					
2					
4					
7					
11					
13					
14					
16					

# INDOOR | Spots & pendants | DISCUS 12V - M10 | JUPITER 12V - M10

All M10 spotlights and pendants can be combined with bases (build-in & build-up) and Juba bases as preferred.  
 Alle M10 Aufbaustrahler und Pendelleuchten können mit Rosetten (In- & Aufbau) und Juba Basen nach Wahl kombiniert werden.

## 60../.. - DISCUS 12V - M10

~12V 0,2100 0,5 m 05.10.02



build-up spot M10 - without transformer  
 Aufbaustrahler M10 - ohne Trafo

### Lamp type

QR-CB 51 GU5,3/GX5,3 (1) 50W 12V

Colour	6005/..	6010/..	6015/..	6020/..	6030/..	6050/..	6080/..
	H 50	H 100	H 150	H 200	H 300	H 500	H 800
1							
2							
4							
7							
11							
13							
14							
16							

## 68../.. - JUPITER 12V - M10

~12V 0,2050 0,5 m 05.10.02



build-up spot M10 - without transformer  
 Aufbaustrahler M10 - ohne Trafo

### Lamp type

QR-CB 51 coolfit GU5,3/GX5,3 (1) 35W 12V

Colour	6805/..	6810/..	6815/..	6820/..	6830/..
	H 70	H 100	H 150	H 200	H 300
1					
2					
4					
7					
11					
13					
14					
16					

use coolfit lamp  
 Coolfit-Lampe verwenden

## INDOOR | Spots & pendants | FOLIO 12V - M10 | VOLTA 12V

All M10 spotlights and pendants can be combined with bases (build-in & build-up) and Juba bases as preferred.  
 Alle M10 Aufbaustrahler und Pendelleuchten können mit Rosetten (In- & Aufbau) und Juba Basen nach Wahl kombiniert werden.

### 64../.. - FOLIO 12V - M10

~12V IP20 0.3060 0.5 m 05.10.02

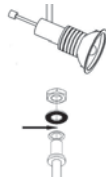

build-up spot M10 - without transformer  
 Aufbaustrahler M10 - ohne Trafo

#### Lamptype

⊲ QR-LP70 BA15d (1) 50W 12V

Colour	6405/..	6410/..	6415/..	6420/..	6430/..	6450/..	6480/..
	H 70	H 100	H 150	H 200	H 300	H 500	H 800
1							
2							
4							
7							
11							
14							
16							
23							

### 1956.10../.. - VOLTA 12V - M10

~12V IP20 0.5 05.10.02



build-up spot M10 - without transformer  
 Aufbaustrahler M10 - ohne Trafo

#### Ref

#### Lamptype

⊲ QR-LP70 BA15d (1) 50W 12V

#### Dimensions

↔ Ø78,5xL90 - Bar 100

1956.10.1M  
 1956.10.7  
 1956.10.10  
 1956.10.13  
 1956.10.14  
 1956.10.23

build-up  
 other lengths on request  
 andere Längen auf Anfrage

### 1956../.. - VOLTA 12V - M10

~12V IP20 0.5 05.10.02



build-up spot M10 - without rod - without transformer  
 Aufbaustrahler M10 - ohne Stange - ohne Trafo

#### Ref

#### Lamptype

⊲ QR-LP70 BA15d (1) 50W 12V

#### Dimensions

↔ Ø78,5xL120

1956.1M  
 1956.7  
 1956.10  
 1956.13  
 1956.14  
 1956.23

build-up



# INDOOR | Spots & pendants | UTOPIE 12V - M10 | GLOBO 12V - M10

All M10 spotlights and pendants can be combined with bases (build-in & build-up) and Juba bases as preferred.  
 Alle M10 Aufbaustrahler und Pendelleuchten können mit Rosetten (In- & Aufbau) und Juba Basen nach Wahl kombiniert werden.

## 62../.. - UTOPIE 12V - M10

~12V



build-up spot M10 - without transformer  
 Aufbaustrahler M10 - ohne Trafo

### Lamp type

QR-LP111 G53 (1) 50W 12V

Colour	6210/..	6215/..	6220/..	6230/..	6250/..	6280/..
	H 100	H 150	H 200	H 300	H 500	H 800
1						
2						
4						
7						
13						
14						
16						

## 1809../.. - GLOBO 12V - M10

~12V



build-up spot M10 - without transformer  
 Aufbaustrahler M10 - ohne Trafo

### Lamp type

QR-LP111 G53 (1) 50W 12V

Colour	1809.10/..	1809.15/..	1809.20/..	1809.30/..
	H 100	H 150	H 200	H 300
1M				
2M				
7				
11M				
13				
23				

# INDOOR | Spots & pendants | APOLLO 12V - M10 | SATURNO 12V -M10 | CUBIC 12V

All M10 spotlights and pendants can be combined with bases (build-in & build-up) and Juba bases as preferred.  
 Alle M10 Aufbaustrahler und Pendelleuchten können mit Rosetten (In- & Aufbau) und Juba Basen nach Wahl kombiniert werden.

## 66../.. - APOLLO 12V - M10

~12V 0,1070 0,5 m 05.10.02



build-up spot M10 - without transformer  
 Aufbaustrahler M10 - ohne Trafo

### Lamptype

◁ QR-CB 51 GU5,3/GX5,3 (1) 50W 12V

Colour	6610/..	6615/..	6620/..	6630/..
	H 100	H 150	H 200	H 300
	14			

## 67../.. - SATURNO 12V -M10

~12V 0,1590 0,5 m 05.10.02



build-up spot M10 - without transformer  
 Aufbaustrahler M10 - ohne Trafo

### Lamptype

◁ QR-CB 51 coolfit GU5,3/GX5,3 (1) 50W 12V

Colour	6710/..	6715/..	6720/..	6730/..
	H 100	H 150	H 200	H 300
	14			

use coolfit lamp  
 Coolfit-Lampe verwenden

## 74.65../.. - CUBIC 12V - M10

~12V 0,1420 0,5 m 05.10.02



build-up spot M10 - without transformer  
 Aufbaustrahler M10 - ohne Trafo

### Ref

74.65.14

### Lamptype

◁ QR-CB 51 GU5,3/GX5,3 (1) 50W 12V

### Dimensions

↔ B55xH80 - Bar 65

build-up  
 M10x1

## 74.100../.. - CUBIC 12V - M10

~12V 0,1570 0,5 m 05.10.02



build-up spot M10 - without transformer  
 Aufbaustrahler M10 - ohne Trafo

### Ref

74.100.14

### Lamptype

◁ QR-CB 51 GU5,3/GX5,3 (1) 50W 12V

### Dimensions

↔ B55xH115 - Bar 100

build-up  
 M10x1

# INDOOR | Spots & pendants | CRICKET 12V | TWIST 12V | COMMA 12V

All M10 spotlights and pendants can be combined with bases (build-in & build-up) and Juba bases as preferred.  
 Alle M10 Aufbaustrahler und Pendelleuchten können mit Rosetten (In- & Aufbau) und Juba Basen nach Wahl kombiniert werden.

## 1288/.. - CRICKET 12V

~12V S1 IP20 0,2000 0,5 m 05.10.02



build-up spot with build-in rosette - without transformer  
 Aufbaustrahler mit Einbaurosette - ohne Trafo

Ref  
 1288.14

### Lamptype

QR-CB 51 GU5,3/GX5,3 (1) 50W 12V

### Dimensions

Ø60xH75  
 Ø40 45

build-in

## 6500/.. - TWIST 12V - B3

~12V IP20 0,0800 0,5 m 05.10.02



build-up spot with swivel - without transformer  
 Aufbaustrahler mit Kugelgelenk - ohne Trafo

Ref

6500.1  
 6500.2  
 6500.4  
 6500.7  
 6500.11  
 6500.13  
 6500.14  
 6500.16

### Lamptype

QR-CB 51 GU5,3/GX5,3 (1) 50W 12V

### Options

33M10/.. - ZIA BASE Ø30  
 43M10/.. - ZIA BASE Ø39-40

to combine with 33M or 43M  
 zu kombinieren mit 33M oder 43M

## 3004.DISCUS/.. - COMMA 12V - M10

~12V IP20 0,2275 0,5 m 05.10.02



build-up spot M10 - without transformer  
 Aufbaustrahler M10 - ohne Trafo

Ref

3004.DISCUS.1  
 3004.DISCUS.2  
 3004.DISCUS.4  
 3004.DISCUS.7  
 3004.DISCUS.11  
 3004.DISCUS.13  
 3004.DISCUS.14  
 3004.DISCUS.16

### Lamptype

QR-CB 51 GU5,3/GX5,3 (1) 50W 12V

### Dimensions

D350 - Bar 500

build-up  
 standard 500mm - 200-300-400mm on request  
 standard 500mm - 200-300-400mm auf Anfrage

## 3004.JUPITER/.. - COMMA 12V - M10

~12V IP20 0,2150 0,5 m 05.10.02



build-up spot M10 - without transformer  
 Aufbaustrahler M10 - ohne Trafo

Ref

3004.JUPITER.1  
 3004.JUPITER.2  
 3004.JUPITER.4  
 3004.JUPITER.7  
 3004.JUPITER.11  
 3004.JUPITER.13  
 3004.JUPITER.14  
 3004.JUPITER.16

### Lamptype

QR-CB 51 coolfit GU5,3/GX5,3 (1) 35W 12V

### Dimensions

D350 - Bar 500

build-up  
 standard 500mm - 200-300-400mm on request - use  
 coolfit lamp  
 standard 500mm - 200-300-400mm auf Anfrage -  
 Coolfit-Lampe verwenden

## INDOOR | Spots & pendants | COMMA 12V | COMMA MT

All M10 spotlights and pendants can be combined with bases (build-in & build-up) and Juba bases as preferred.  
 Alle M10 Aufbaustrahler und Pendelleuchten können mit Rosetten (In- & Aufbau) und Juba Basen nach Wahl kombiniert werden.

### 3004.STEP/.. - COMMA 12V - M10

~12V   IP20    0,1720  0,5 m  05.10.02 

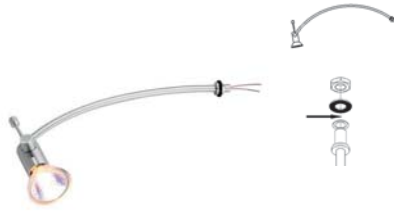

build-up spot M10 - without transformer  
 Aufbaustrahler M10 - ohne Trafo

#### Lamptype

QR-CB 51 GU5,3/GX5,3 (1) 50W 12V

#### Dimensions

D350 - Bar 500

#### Ref

3004.STEP.1  
 3004.STEP.2  
 3004.STEP.4  
 3004.STEP.7  
 3004.STEP.11  
 3004.STEP.13  
 3004.STEP.14  
 3004.STEP.16

#### build-up

standard 500mm - 200-300-400mm on request  
 standard 500mm - 200-300-400mm auf Anfrage

### 3005.DISCUS/.. - COMMA MT

~230V   IP20    0,6080  0,5 m  05.10.02 



build-up wall light - with transformer  
 Wandleuchte für Aufbau - mit Trafo

#### Lamptype

QR-CB 51 GU5,3/GX5,3 (1) 50W 12V

#### Dimensions

L590xB350 - Bar 500

L90xB39

#### Ref

3005.DISCUS.1  
 3005.DISCUS.2  
 3005.DISCUS.4  
 3005.DISCUS.7  
 3005.DISCUS.11  
 3005.DISCUS.13  
 3005.DISCUS.14  
 3005.DISCUS.16

#### build-up

60VA - standard 500mm max. - 200-300-400mm on request  
 60VA - standard 500mm max. - 200-300-400mm auf Anfrage

### 3005.JUPITER/.. - COMMA MT

~230V   IP20    0,5870  0,5 m  05.10.02 



build-up wall light - with transformer  
 Wandleuchte für Aufbau - mit Trafo

#### Lamptype

QR-CB 51 coolfit GU5,3/GX5,3 (1) 35W 12V

#### Dimensions

L590xB350 - Bar 500

L90xB39

#### Ref

3005.JUPITER.1  
 3005.JUPITER.2  
 3005.JUPITER.4  
 3005.JUPITER.7  
 3005.JUPITER.11  
 3005.JUPITER.13  
 3005.JUPITER.14  
 3005.JUPITER.16

#### build-up

60VA - standard 500mm max. - 200-300-400mm on request - use coolfit lamp  
 60VA - standard 500mm max. - 200-300-400mm auf Anfrage - Coolfit- Lampe verwenden

### 3005.STEP/.. - COMMA MT

~230V   IP20    0,5845  0,5 m  05.10.02 



build-up wall light - with transformer  
 Wandleuchte für Aufbau - mit Trafo

#### Lamptype

QR-CB 51 GU5,3/GX5,3 (1) 50W 12V

#### Dimensions

L590xB350 - Bar 500

L90xB39

#### Ref

3005.STEP.1  
 3005.STEP.2  
 3005.STEP.4  
 3005.STEP.7  
 3005.STEP.11  
 3005.STEP.13  
 3005.STEP.14  
 3005.STEP.16

#### build-up

60VA - standard 500mm max. - 200-300-400mm on request  
 60VA - standard 500mm max. - 200-300-400mm auf Anfrage

# INDOOR | Spots & pendants | DISCUS 230V - M10 | STEP 230V - M10

All M10 spotlights and pendants can be combined with bases (build-in & build-up) and Juba bases as preferred.  
 Alle M10 Aufbaustrahler und Pendelleuchten können mit Rosetten (In- & Aufbau) und Juba Basen nach Wahl kombiniert werden.

## HI.60../.. - DISCUS 230V - M10

~230V  IP20     0,4410  1 m  05.10.02 



build-up spot M10  
 Aufbaustrahler M10

### Lamptype

 QPAR 51 GU10 (1) 50W 230V

Colour	HI.6005/..	HI.6010/..	HI.6015/..	HI.6020/..	HI.6030/..	HI.6050/..	HI.6080/..
	H 70	H 100	H 150	H 200	H 300	H 500	H 800
1							
2							
4							
7							
11							
13							
14							
16							

## HI.63../.. - STEP 230V - M10

~230V  IP20     0,2800  1 m  05.10.02 



build-up spot M10  
 Aufbaustrahler M10

### Lamptype

 QPAR 51 GU10 (1) 50W 230V

Colour	HI.6305/..	HI.6310/..	HI.6315/..	HI.6320/..	HI.6330/..	HI.6350/..	HI.6380/..
	H 70	H 100	H 150	H 200	H 300	H 500	H 800
1							
2							
4							
7							
11							
13							
14							
16							

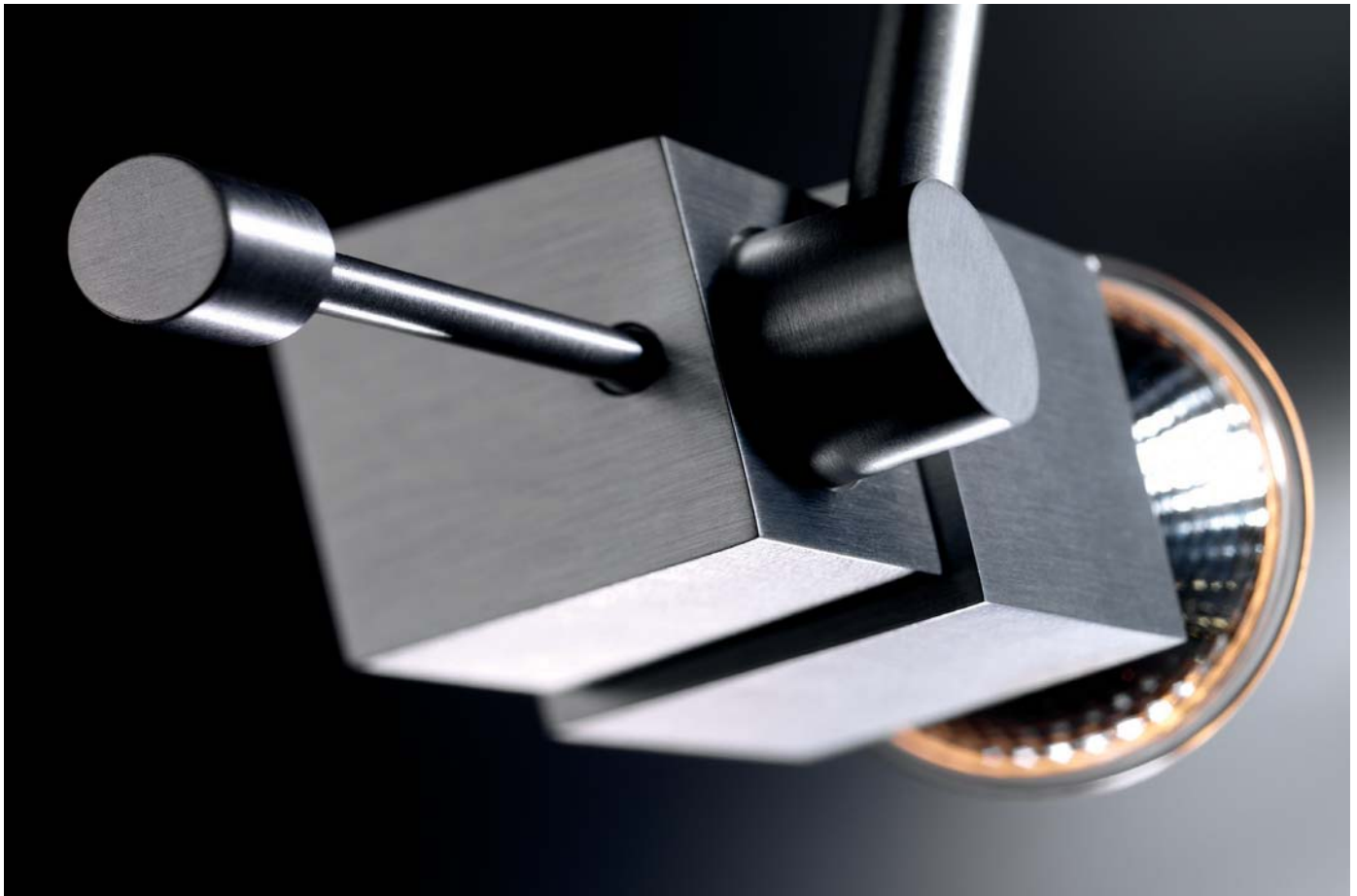

**INDOOR | Spots & pendants | CAPRI 230V - M10 | APOLLO 230V | SATURNO 230V - M10**

All M10 spotlights and pendants can be combined with bases (build-in & build-up) and Juba bases as preferred.  
 Alle M10 Aufbaustrahler und Pendelleuchten können mit Rosetten (In- & Aufbau) und Juba Basen nach Wahl kombiniert werden.

**HI.71../.. - CAPRI 230V - M10**

~230V  IP20     1 m  



build-up spot M10  
 Aufbaustrahler M10

**Lamptype**

 QPAR 51 GU10 (1) 50W 230V

Colour	HI.7105/..	HI.7110/..	HI.7115/..	HI.7120/..	HI.7130/..	HI.7150/..	HI.7180/..
	H 70	H 100	H 150	H 200	H 300	H 500	H 800
1							
2							
4							
7							
11							
13							
14							
16							

**HI.66../.. - APOLLO 230V**

~230V  IP20     0,1960 1 m  



build-up spot M10  
 Aufbaustrahler M10

**Lamptype**

 QPAR 51 GU10 (1) 50W 230V

Colour	HI.6610/..	HI.6615/..	HI.6620/..	HI.6630/..
	H 100	H 150	H 200	H 300
14				

**HI.67../.. - SATURNO 230V - M10**

~230V  IP20     0,3060 1 m  



build-up spot M10  
 Aufbaustrahler M10

**Lamptype**

 QPAR-CB 51 GZ10 (1) 50W 230V

Colour	HI.6710/..	HI.6715/..	HI.6720/..	HI.6730/..
	H 100	H 150	H 200	H 300
14				

# INDOOR | Spots & pendants | DISCUS + LED - M10 | STEP + LED - M10

All M10 spotlights and pendants can be combined with bases (build-in & build-up) and Juba bases as preferred.  
 Alle M10 Aufbaustrahler und Pendelleuchten können mit Rosetten (In- & Aufbau) und Juba Basen nach Wahl kombiniert werden.

## L.60../.. - DISCUS + LED - M10

=700mA



other °angle reflector on request  
 andere °Winkel Reflektor auf Anfrage



build-up spot LED M10 - cold white LED included - without LED driver  
 Aufbaustrahler LED M10 - LED kalt Weiß einbegriffen - ohne Driver LED

### Lamptype

powered 700mA . (1) 3W 700mA

### Afmetingen/Dimensions

40° reflector

Colour	L.6005/..	L.6010/..	L.6015/..	L.6020/..	L.6030/..	L.6050/..	L.6080/..
	H 70	H 100	H 150	H 200	H 300	H 500	H 800
1							
2							
4							
7							
11							
13							
14							
16							

## L.63../.. - STEP + LED - M10

=700mA



other °angle reflector on request  
 andere °Winkel Reflektor auf Anfrage



build-up spot LED M10 - cold white LED included - without LED driver  
 Aufbaustrahler LED M10 - LED kalt Weiß einbegriffen - ohne Driver LED

### Lamptype

powered 700mA . (1) 3W 700mA

### Afmetingen/Dimensions

40° reflector

Colour	L.6305/..	L.6310/..	L.6315/..	L.6320/..	L.6330/..	L.6350/..	L.6380/..
	H 70	H 100	H 150	H 200	H 300	H 500	H 800
1							
2							
4							
7							
11							
13							
14							
16							



## INDOOR | Spots & pendants | CUBIC + LED

All M10 spotlights and pendants can be combined with bases (build-in & build-up) and Juba bases as preferred.  
 Alle M10 Aufbaustrahler und Pendelleuchten können mit Rosetten (In- & Aufbau) und Juba Basen nach Wahl kombiniert werden.

### 74LED.65/.. - CUBIC + LED - M10

=700mA   IP20    0,0650  0,5 m  05.10.02 



build-up spot LED M10 - LED included - without LED driver  
 Aufbaustrahler LED M10 - inklusive LED - ohne Driver LED

#### Ref

74LED.65.14.CW

#### Lamp type

 powered 700mA . (1) 3W 700mA

74LED.65.14.WW

#### Dimensions

 B60xH80  40° reflector - Bar 65

*build-up*  
 other °angle reflector on request  
 andere °Winkel Reflektor auf Anfrage

### 74LED.100/.. - CUBIC + LED - M10

=700mA   IP20    0,0725  0,5 m  05.10.02 



build-up spot LED M10 - LED included - without LED driver  
 Aufbaustrahler LED M10 - inklusive LED - ohne Driver LED

#### Ref

74LED.100.14.CW

#### Lamp type

 powered 700mA . (1) 3W 700mA

74LED.100.14.WW

#### Dimensions

 B60xH115  40° reflector - Bar 100

*build-up*  
 other °angle reflector on request  
 andere °Winkel Reflektor auf Anfrage



LED colours: cold white (CW) or warm white (WW) - other LED colours on request  
 LED Farben: kalt Weiß (CW) oder warm Weiß (WW) - andere LED Farben auf Anfrage

**3023/././.. - ORKA M10**

=700mA IP20 0.5 05.10.02 CE



build-up spotlight LED M10 with flexible tube - without LED driver  
 Aufbaustrahler LED M10 mit flexibler Tube - ohne Driver LED

**Lamptype**  
 powered 700mA . (1) 3W 700mA

**Dimensions**  
 Ø50 40° reflector

Colour	3023.300/..	3023.400/..	3023.500/..
	H 300	H 400	H 500
7.CW			
7.WW			
10.CW			
10.WW			
14.CW			
14.WW			

build-up  
 other °angle reflector on demand  
 andere °Winkel Reflektor auf Anfrage

Spots & pendants

**3999.G9.B3/.. - PIVA - B3**

~230V IP20 0,2680 1 m 05.10.02 CE



pendant with swivel - rod can be shortened  
 Pendelleuchte mit Kugelgelenk - kürzbare Stange

**Lamptype**  
 QT14 G9 (1) 25W 230V

**Dimensions**  
 Ø30 - Bar 800

**Options**  
 GL5796B/.. - GLASS  
 GL5796O/.. - GLASS  
 GL5796S/.. - GLASS

**Ref**

3999.G9.B3.1
3999.G9.B3.2
3999.G9.B3.4
3999.G9.B3.7
3999.G9.B3.11
3999.G9.B3.13
3999.G9.B3.14
3999.G9.B3.16

glass to be ordered separately  
 Glas separat bestellen

**3999.G9/.. - PIVA - M10**

~230V IP20 0,2040 0,5 m 05.10.02 CE



pendant - glass to be ordered separately  
 Pendelleuchte - Glas separat bestellen

**Lamptype**  
 QT14 G9 (1) 25W 230V

**Dimensions**  
 Ø30 - Bar 800

**Options**  
 GL5796B/.. - GLASS  
 GL5796O/.. - GLASS  
 GL5796S/.. - GLASS

**Ref**

3999.G9.1
3999.G9.2
3999.G9.4
3999.G9.7
3999.G9.11
3999.G9.13
3999.G9.14
3999.G9.16

other lengths on request  
 andere Längen auf Anfrage

GL5796S/.. - GLASS

IP20    0,1790 



Glass - silk satin  
Glas - silk Satin

Ref  
GL5796S

Dimensions

↔ Ø80xH80

Options

3999.G9.B3/.. - PIVA  
3999.G9/.. - PIVA

rod not included  
Stange nicht einbegriffen

GL5796B/.. - GLASS

IP20    0,1710 



Glass - transparent blue  
Glas - transparentes Blau

Ref  
GL5796B

Dimensions

↔ Ø80xH80

Options

3999.G9.B3/.. - PIVA  
3999.G9/.. - PIVA

rod not included  
Stange nicht einbegriffen

GL5796O/.. - GLASS

IP20    0,1740 



Glass - transparent orange  
Glas - transparentes Orange

Ref  
GL5796O

Dimensions

↔ Ø80xH80

Options

3999.G9.B3/.. - PIVA  
3999.G9/.. - PIVA

rod not included  
Stange nicht einbegriffen

4001.G4/.. - PIVA - M10

~12V   IP20    0,1889  0,5 m  05.10.02 



pendant - without transformer  
Pendelleuchte - ohne Trafo

Ref  
4001.G4.1  
4001.G4.2  
4001.G4.4  
4001.G4.7  
4001.G4.11  
4001.G4.13  
4001.G4.14  
4001.G4.16  
4001.G4.18

Lamptype

≡ QT9-ax G4 (1) 20W 12V

Dimensions

↔ Ø30 - Bar 800

build-up  
other lengths on request - glass to order separately  
andere Längen auf Anfrage - Glas separat bestellen

All M10 spotlights and pendants can be combined with bases (build-in & build-up) and Juba bases as preferred.  
 Alle M10 Aufbaustrahler und Pendelleuchten können mit Rosetten (In- & Aufbau) und Juba Basen nach Wahl kombiniert werden.

**4001.G4.B3/.. - PIVA - B3**

~12V



pendant with swivel - rod can be shortened - without transformer  
 Pendelleuchte mit Kugelgelenk - kürzbare Stange - ohne Trafo

**Lamptype**

QT9-ax G4 (1) 20W 12V

**Dimensions**

Ø30 - Bar 800

**Ref**

- 4001.G4.B3.1
- 4001.G4.B3.2
- 4001.G4.B3.4
- 4001.G4.B3.7
- 4001.G4.B3.11
- 4001.G4.B3.13
- 4001.G4.B3.14
- 4001.G4.B3.16
- 4001.G4.B3.18

*build-up  
 glass to order separately  
 Glas separat bestellen*

**4001.G9/.. - PIVA - M10**

~230V

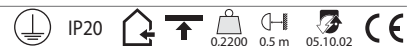

pendant  
 Pendelleuchte

**Lamptype**

QT14 G9 (1) 25W 230V

**Dimensions**

Ø30 - Bar 800

**Ref**

- 4001.G9.1
- 4001.G9.2
- 4001.G9.4
- 4001.G9.7
- 4001.G9.11
- 4001.G9.13
- 4001.G9.14
- 4001.G9.16

*build-up  
 other lengths on request - glass to order separately  
 andere Längen auf Anfrage - Glas separat bestellen*

**4001.G9.B3/.. - PIVA - B3**

~230V



pendant with swivel - rod can be shortened  
 Pendelleuchte mit Kugelgelenk - kürzbare Stange

**Lamptype**

QT14 G9 (1) 25W 230V

**Dimensions**

Ø30 - Bar 800

**Ref**

- 4001.G9.B3.1
- 4001.G9.B3.2
- 4001.G9.B3.4
- 4001.G9.B3.7
- 4001.G9.B3.11
- 4001.G9.B3.13
- 4001.G9.B3.14
- 4001.G9.B3.16

*build-up  
 glass to order separately  
 Glas separat bestellen*

**PIGLAS/.. - GLASS G4**



Glass - crystal 513100 - opal 513007  
 Glas - Kristall 513100 - Opal 513007

**Dimensions**

Ø100xH105

**Options**

- 4001.G4.B3/.. - PIVA
- 4001.G4/.. - PIVA

**Ref**

PIGLAS

*rod not included  
 Stange nicht einbegriffen*

185807/.. - GLASS G4

IP20    0,1200 



Glass - opal matt  
Glas - Opal matt

Ref  
185807

**Dimensions**

↔ Ø86xH65

**Options**

4001.G4.B3/.. - PIVA  
4001.G4/.. - PIVA

rod not included  
Stange nicht einbegriffen

174320/.. - GLASS G4

IP20    0,1900 



Glass - alabaster cream  
Glas - Alabaster Ceme

Ref  
174320

**Dimensions**

↔ Ø126xH72

**Options**

4001.G4.B3/.. - PIVA  
4001.G4/.. - PIVA

rod not included  
Stange nicht einbegriffen

175820/.. - GLASS G4

IP20    0,1400 



Glass - alabaster cream  
Glas - Alabaster Ceme

Ref  
175820

**Dimensions**

↔ Ø86xH65

**Options**

4001.G4.B3/.. - PIVA  
4001.G4/.. - PIVA

rod not included  
Stange nicht einbegriffen

464907/.. - GLASS G4-G9

IP20    0,2720 



Glass - opal white  
Glas - Opalweiß

Ref  
464907

**Dimensions**

↔ L80xB80xH100

**Options**

4001.G4.B3/.. - PIVA  
4001.G4/.. - PIVA  
4001.G9.B3/.. - PIVA  
4001.G9/.. - PIVA

rod not included  
Stange nicht einbegriffen

**GL413G/.. - GLASS G4-G9**

IP20    0,3320 



Glass - Robellat Oro  
 Glas - Robellat Oro

Ref  
 GL413G

**Dimensions**

↔ Ø95xH110

**Options**

- 4001.G4.B3/.. - PIVA
- 4001.G4/.. - PIVA
- 4001.G9.B3/.. - PIVA
- 4001.G9/.. - PIVA

rod not included  
 Stange nicht einbegriffen

**521406/.. - GLASS G4**

IP20    0,3350 



Glass - Clear on the outside - white opal on the inside  
 Glas - Klar auf der Außenseite- Weiß Opal auf der Innenseite

Ref  
 521406

**Dimensions**

↔ L70xB70xH75

**Options**

- 4001.G4.B3/.. - PIVA
- 4001.G4/.. - PIVA

rod not included  
 Stange nicht einbegriffen

**121607/.. - GLASS G4**

IP20    0,1600 



Glass - matt white  
 Glas - Weiß matt

Ref  
 121607

**Dimensions**

↔ Ø155xH50

**Options**

- 4001.G4.B3/.. - PIVA
- 4001.G4/.. - PIVA

rod not included  
 Stange nicht einbegriffen

**184307/.. - GLASS G4**

IP20    0,1200 



Glass - opal matt  
 Glas - Opal matt

Ref  
 184307

**Dimensions**

↔ Ø126xH72

**Options**

- 4001.G4.B3/.. - PIVA
- 4001.G4/.. - PIVA

rod not included  
 Stange nicht einbegriffen

GL5911S/.. - GLASS G4-G9

IP20    0,2840 



Glass - silk satin  
Glas - silk Satin

Ref  
GL5911S

**Dimensions**

↔ Ø110xH95

**Options**

- 4001.G4.B3/.. - PIVA
- 4001.G4/.. - PIVA
- 4001.G9.B3/.. - PIVA
- 4001.G9/.. - PIVA

rod not included  
Stange nicht einbegriffen

GL5911R/.. - GLASS G4-G9

IP20    0,2880 



Glass - red  
Glas - Rot

Ref  
GL5911R

**Dimensions**

↔ Ø110xH95

**Options**

- 4001.G4.B3/.. - PIVA
- 4001.G4/.. - PIVA
- 4001.G9.B3/.. - PIVA
- 4001.G9/.. - PIVA

rod not included  
Stange nicht einbegriffen

GL5952S/.. - GLASS G4-G9

IP20    0,2080 



Glass - silk satin  
Glas - silk Satin

Ref  
GL5952S

**Dimensions**

↔ Ø80xH75

**Options**

- 4001.G4.B3/.. - PIVA
- 4001.G4/.. - PIVA
- 4001.G9.B3/.. - PIVA
- 4001.G9/.. - PIVA

rod not included  
Stange nicht einbegriffen

GL5952G/.. - GLASS G4-G9

IP20    0,2080 



Glass - lino grigio  
Glas - Linie Grau

Ref  
GL5952G

**Dimensions**

↔ Ø80xH75

**Options**

- 4001.G4.B3/.. - PIVA
- 4001.G4/.. - PIVA
- 4001.G9.B3/.. - PIVA
- 4001.G9/.. - PIVA

rod not included  
Stange nicht einbegriffen

**GL5952R/.. - GLASS G4-G9**

IP20    0,2080 



Glass - lino rosso  
Glas - Linie Rot

Ref  
GL5952R

**Dimensions**  
↔ Ø80xH75

**Options**  
4001.G4.B3/.. - PIVA  
4001.G4/.. - PIVA  
4001.G9.B3/.. - PIVA  
4001.G9/.. - PIVA

rod not included  
Stange nicht einbegriffen

**GL5952A/.. - GLASS G4-G9**

IP20    0,2300 



Glass - lino arancio  
Glas - Linie Orange

Ref  
GL5952A

**Dimensions**  
↔ Ø80xH75

**Options**  
4001.G4.B3/.. - PIVA  
4001.G4/.. - PIVA  
4001.G9.B3/.. - PIVA  
4001.G9/.. - PIVA

rod not included  
Stange nicht einbegriffen

**GL2592SS/.. - GLASS G4**

IP20   



Glass - Clear on the outside - white opal on the inside  
Glas - Klar auf der Außenseite- Weiß Opal auf der Innenseite

Ref  
GL2592SS

**Dimensions**  
↔ L60xB60xH70

**Options**  
4001.G4.B3/.. - PIVA  
4001.G4/.. - PIVA

rod not included  
Stange nicht einbegriffen

**GL2581S/.. - GLASS G4**

IP20   



Glass - silk satin cube  
Glas - silk Satin Kubus

Ref  
GL2581S

**Dimensions**  
↔ L60xB60xH70

**Options**  
4001.G4.B3/.. - PIVA  
4001.G4/.. - PIVA

rod not included  
Stange nicht einbegriffen

**GL553S/.. - GLASS G4**

IP20    1,2960 



Glass - silk satin rosis  
Glas - silk Satin rosis

Ref

GL553S

**Dimensions**

↔ Ø63xH70

**Options**

4001.G4.B3/.. - PIVA

4001.G4/.. - PIVA

rod not included  
Stange nicht einbegriffen

**GL5757W/.. - GLASS G4**

IP20    0,1960 



Glass - silk satin  
Glas - silk Satin

Ref

GL5757W

**Dimensions**

↔ Ø73xH70

**Options**

4001.G4.B3/.. - PIVA

4001.G4/.. - PIVA

rod not included  
Stange nicht einbegriffen

**GL5648W/.. - GLASS G4**

IP20    0,2240 



Glass - lino bianco  
Glas - Linie Weiß

Ref

GL5648W

**Dimensions**

↔ Ø125xH75

**Options**

4001.G4.B3/.. - PIVA

4001.G4/.. - PIVA

rod not included  
Stange nicht einbegriffen

**GL8285M/.. - GLASS G4-G9**

IP20    0,4600 



Glass - Madre Perla  
Glas - Madre Perla

Ref

GL8285M

**Dimensions**

↔ Ø95xH100

**Options**

4001.G4.B3/.. - PIVA

4001.G4/.. - PIVA

4001.G9.B3/.. - PIVA

4001.G9/.. - PIVA

rod not included  
Stange nicht einbegriffen



GL8285S/.. - GLASS G4-G9

IP20    0,4654 



Glass - silk satin  
Glas - silk Satin

Ref

GL8285S

**Dimensions**

↔ Ø95xH100

**Options**

- 4001.G4.B3/.. - PIVA
- 4001.G4/.. - PIVA
- 4001.G9.B3/.. - PIVA
- 4001.G9/.. - PIVA

rod not included  
Stange nicht einbegriffen

GL8285BC/.. - GLASS G4-G9

IP20   



Glass - Bean Coffee  
Glas - Bean Coffee

Ref

GL8285BC

**Dimensions**

↔ Ø95xH100

**Options**

- 4001.G4.B3/.. - PIVA
- 4001.G4/.. - PIVA
- 4001.G9.B3/.. - PIVA
- 4001.G9/.. - PIVA

rod not included  
Stange nicht einbegriffen

GL8284M/.. - GLASS G4-G9

IP20   



Glass - Madre Perla  
Glas - Madre Perla

Ref

GL8284M

**Dimensions**

↔ Ø85xH90

**Options**

- 4001.G4.B3/.. - PIVA
- 4001.G4/.. - PIVA
- 4001.G9.B3/.. - PIVA
- 4001.G9/.. - PIVA

rod not included  
Stange nicht einbegriffen

GL8284S/.. - GLASS G4-G9

IP20   



Glass - silk satin  
Glas - silk Satin

Ref

GL8284S

**Dimensions**

↔ Ø85xH90

**Options**

- 4001.G4.B3/.. - PIVA
- 4001.G4/.. - PIVA
- 4001.G9.B3/.. - PIVA
- 4001.G9/.. - PIVA

rod not included  
Stange nicht einbegriffen

**GL8284W/.. - GLASS G4-G9**

IP20    2.3580 



Glass - wenge  
 Glas - Wenge

Ref

GL8284W

**Dimensions**

↔ Ø85xH90

**Options**

- 4001.G4.B3/.. - PIVA
- 4001.G4/.. - PIVA
- 4001.G9.B3/.. - PIVA
- 4001.G9/.. - PIVA

rod not included  
 Stange nicht einbegriffen

**GL5836W/.. - GLASS G4**

IP20   



Glass - wenge  
 Glas - Wenge

Ref

GL5836W

**Dimensions**

↔ Ø80xH75

**Options**

- 4001.G4.B3/.. - PIVA
- 4001.G4/.. - PIVA

rod not included  
 Stange nicht einbegriffen

**GL423S/.. - GLASS G4-G9**

IP20    0.7920 



Glass - silk satin  
 Glas - silk Satin

Ref

GL423S

**Dimensions**

↔ Ø125xH165

**Options**

- 4001.G4.B3/.. - PIVA
- 4001.G4/.. - PIVA
- 4001.G9.B3/.. - PIVA
- 4001.G9/.. - PIVA

rod not included  
 Stange nicht einbegriffen

**GL5434WA/.. - GLASS G4-G9**

IP20   



Glass - incorciato arancio  
 Glas - Schliff Orange

Ref

GL5434WA

**Dimensions**

↔ Ø140xH100

**Options**

- 4001.G4.B3/.. - PIVA
- 4001.G4/.. - PIVA
- 4001.G9.B3/.. - PIVA
- 4001.G9/.. - PIVA

rod not included  
 Stange nicht einbegriffen

GL5434WN/.. - GLASS G4-G9

IP20    0.3918 



Glass - wenge incrociato nero  
 Glas - Schliff Wenge Schwarz

Ref  
 GL5434WN

**Dimensions**

↔ Ø140xH100

**Options**

- 4001.G4.B3/.. - PIVA
- 4001.G4/.. - PIVA
- 4001.G9.B3/.. - PIVA
- 4001.G9/.. - PIVA

rod not included  
 Stange nicht einbegriffen

GL1135S/.. - GLASS G4-G9

IP20    6.2660 



Glass - silk satin  
 Glas - silk Satin

Ref  
 GL1135S

**Dimensions**

↔ Ø175xH135

**Options**

- 4001.G4.B3/.. - PIVA
- 4001.G4/.. - PIVA
- 4001.G9.B3/.. - PIVA
- 4001.G9/.. - PIVA

rod not included  
 Stange nicht einbegriffen

GL1129W/.. - GLASS G4-G9

IP20    0.5400 



Glass - silk satin  
 Glas - silk Satin

Ref  
 GL1129W

**Dimensions**

↔ Ø150xH75

**Options**

- 4001.G4.B3/.. - PIVA
- 4001.G4/.. - PIVA
- 4001.G9.B3/.. - PIVA
- 4001.G9/.. - PIVA

rod not included  
 Stange nicht einbegriffen

GL5994CA/.. - GLASS G4-G9

IP20   



Glass - Ceramico Ambra  
 Glas - Amber Keramik

Ref  
 GL5994CA

**Dimensions**

↔ Ø140xH95

**Options**

- 4001.G4.B3/.. - PIVA
- 4001.G4/.. - PIVA
- 4001.G9.B3/.. - PIVA
- 4001.G9/.. - PIVA

rod not included  
 Stange nicht einbegriffen

# INDOOR | Spots & pendants | GLASS G4-G9 | FLEX | TUBA

All M10 spotlights and pendants can be combined with bases (build-in & build-up) and Juba bases as preferred.  
 Alle M10 Aufbaustrahler und Pendelleuchten können mit Rosetten (In- & Aufbau) und Juba Basen nach Wahl kombiniert werden.

## GL5995SMS/.. - GLASS G4-G9

IP20   0,4616 



Glass - Silk matt satinato  
 Glas - silk matt Satin

Ref

GL5995SMS

### Dimensions

↔ Ø140xH90

### Options

- 4001.G4.B3/.. - PIVA
- 4001.G4/.. - PIVA
- 4001.G9.B3/.. - PIVA
- 4001.G9/.. - PIVA

rod not included  
 Stange nicht einbegriffen

## 4002/..../.. - FLEX

~12V   IP20    0,5 m  05.10.02 



flexible tube for pendant - only for G4 - without transformer  
 flexible Tube für Pendelleuchte - nur für G4 - ohne Trafo

### Lamp type

⇨ QT9-ax G4 (1) 20W 12V

Colour	4002.300/..	4002.400/..	4002.500/..	4002.600/..	4002.800/..
	H 300	H 400	H 500	H 600	H 800
11					
16					

## 4003.B3/.. - TUBA - B3

~12V   IP20    0,1827  0,5 m  05.10.02 



pendant with swivel - rod can be shortened - without transformer  
 Pendelleuchte mit Kugelgelenk - kürzbare Stange - ohne Trafo

Ref

4003.B3.1

4003.B3.2

4003.B3.4

### Lamp type

⇨ QR-CB 51 coolfit GU5,3/GX5,3 (1) 35W 12V

4003.B3.7

### Dimensions

↔ Ø60xH121 - Bar 800

4003.B3.11

4003.B3.13

4003.B3.14

4003.B3.16

4003.B3.18

build-up  
 use coolfit lamp  
 Coolfit-Lampe verwenden

## 4003/.. - TUBA - M10

~12V   IP20    0,1811  0,5 m  05.10.02 



pendant - without transformer  
 Pendelleuchte - ohne Trafo

Ref

4003.1

### Lamp type

⇨ QR-CB 51 coolfit GU5,3/GX5,3 (1) 35W 12V

4003.2

4003.4

### Dimensions

↔ Ø60xH121 - Bar 800

4003.7

4003.11

4003.13

4003.14

4003.16

4003.18

build-up  
 other lengths on request - use coolfit lamp  
 andere Längen auf Anfrage - Coolfit-Lampe verwenden

All M10 spotlights and pendants can be combined with bases (build-in & build-up) and Juba bases as preferred.  
 Alle M10 Aufbaustrahler und Pendelleuchten können mit Rosetten (In- & Aufbau) und Juba Basen nach Wahl kombiniert werden.

**4004.B3/.. - LUNA - B3**

~12V



pendant with swivel - rod can be shortened - without transformer  
 Pendelleuchte mit Kugelgelenk - kürzbare Stange - ohne Trafo

**Ref**

- 4004.B3.1
- 4004.B3.2
- 4004.B3.4
- 4004.B3.7
- 4004.B3.11
- 4004.B3.13
- 4004.B3.14
- 4004.B3.16
- 4004.B3.18

**Lamp type**

QR-CB 51 coolfit GU5,3/GX5,3 (1) 35W 12V

**Dimensions**

Ø60xH92 - Bar 800  
 4mm glass - Glas

*build-up*  
 use coolfit lamp  
 Coolfit-Lampe verwenden

**4004/.. - LUNA - M10**

~12V



pendant - without transformer  
 Pendelleuchte - ohne Trafo

**Ref**

- 4004.1
- 4004.2
- 4004.4
- 4004.7
- 4004.11
- 4004.13
- 4004.14
- 4004.16
- 4004.18

**Lamp type**

QR-CB 51 coolfit GU5,3/GX5,3 (1) 35W 12V

**Dimensions**

Ø60xH92 - Bar 800  
 4mm glass - Glas

*build-up*  
 other lengths on request - use coolfit lamp  
 andere Längen auf Anfrage - Coolfit-Lampe verwenden

**4000.00/.. - LUNA**



supplement - cobalt blue glass  
 Supplement - Kobaltblaues Glas

**Ref**

- 4000.00

**Dimensions**

Ø130  
 4mm glass - Glas

**Options**

- 4004.B3/.. - LUNA
- 4004/.. - LUNA

**4000.01/.. - LUNA spare glass**



spare glass - sandblasted white glass  
 Ersatzglas - weiß sandgestrahtes Glas

**Ref**

- 4000.01

**Dimensions**

Ø130  
 4mm glass - Glas

## INDOOR | Spots & pendants | LUNA spare glass | MAX | MAX spare glass

All M10 spotlights and pendants can be combined with bases (build-in & build-up) and Juba bases as preferred.  
 Alle M10 Aufbaustrahler und Pendelleuchten können mit Rosetten (In- & Aufbau) und Juba Basen nach Wahl kombiniert werden.

### 4000.02/.. - LUNA spare glass

IP20   0,0730 



spare glass - cobalt blue glass  
 Ersatzglas - Kobaltblaues Glas

Ref  
 4000.02

#### Dimensions

↔ Ø130  
 4mm glass - Glas

### 4025.B3/.. - MAX - B3

~12V

  IP20    0,2350  0,5 m  05.10.02 



pendant with swivel - rod can be shortened - without transformer  
 Pendelleuchte mit Kugelgelenk - kürzbare Stange - ohne Trafo

Ref  
 4025.B3.14  
 4025.B3.16

#### Lamptype

 QT12 GY6,35 (1) 35W 12V

#### Dimensions

↔ L60xB60xH150 - Bar 800

build-up

### 4025/.. - MAX - M10

~12V

  IP20    0,5675  0,5 m  05.10.02 



pendant - without transformer  
 Pendelleuchte - ohne Trafo

Ref  
 4025.14  
 4025.16

#### Lamptype

 QT12 GY6,35 (1) 35W 12V

#### Dimensions

↔ L60xB60xH150 - Bar 800

build-up  
 other lengths on request  
 andere Längen auf Anfrage

### 461507/.. - MAX spare glass

IP20    0,3150 



spare glass - opal white  
 Ersatzglas - Opalweiß

Ref  
 461507

#### Dimensions

↔ L60xB60xH150

rod not included  
 Stange nicht einbegriffen

# INDOOR | Spots & pendants | GUILIA A | GUILIA A spare glass | GUILIA B

All M10 spotlights and pendants can be combined with bases (build-in & build-up) and Juba bases as preferred.  
 Alle M10 Aufbaustrahler und Pendelleuchten können mit Rosetten (In- & Aufbau) und Juba Basen nach Wahl kombiniert werden.

## 4026.B3/.. - GUILIA A - B3

~12V



pendant with swivel - rod can be shortened - without transformer  
 Pendelleuchte mit Kugelgelenk - kürzbare Stange - ohne Trafo

### Ref

4026.B3.14  
 4026.B3.16

### Lamp type

⇒ QT12 GY6,35 (1) 35W 12V

### Dimensions

↔ Ø60xH120 - Bar 800

## 4026/.. - GUILIA A - M10

~12V



pendant - without transformer  
 Pendelleuchte - ohne Trafo

### Ref

4026.14  
 4026.16

### Lamp type

⇒ QT12 GY6,35 (1) 35W 12V

### Dimensions

↔ Ø60xH120 - Bar 800

*build-up  
 other lengths on request  
 andere Längen auf Anfrage*

## R1029/.. - GUILIA A spare glass



spare glass  
 Ersatzglas

### Ref

R1029

### Dimensions

↔ Ø60xH120

*rod not included  
 Stange nicht einbegriffen*

## 4027.B3/.. - GUILIA B - B3

~12V



pendant with swivel - rod can be shortened - without transformer  
 Pendelleuchte mit Kugelgelenk - kürzbare Stange - ohne Trafo

### Ref

4027.B3.14  
 4027.B3.16

### Lamp type

⇒ QT12 GY6,35 (1) 35W 12V

### Dimensions

↔ Ø60xH120 - Bar 800

## INDOOR | Spots & pendants | GUILIA B | GUILIA B spare glass | GUILIA C

All M10 spotlights and pendants can be combined with bases (build-in & build-up) and Juba bases as preferred.  
 Alle M10 Aufbaustrahler und Pendelleuchten können mit Rosetten (In- & Aufbau) und Juba Basen nach Wahl kombiniert werden.

### 4027/.. - GUILIA B - M10

~12V 0,4170 0,5 m



pendant - without transformer  
 Pendelleuchte - ohne Trafo

Ref

4027.14

#### Lamptype

QT12 GY6,35 (1) 35W 12V

4027.16

#### Dimensions

Ø60xH120 - Bar 800

*build-up*  
*other lengths on request*  
*andere Längen auf Anfrage*

### R1028/.. - GUILIA B spare glass

IP20 0,1060



spare glass  
 Ersatzglas

Ref

R1028

#### Dimensions

Ø60xH120

*rod not included*  
*Stange nicht einbegriffen*

### 4028.B3/.. - GUILIA C - B3

~12V 0,5500 0,5 m



pendant with swivel - rod can be shortened - glass GL2718CG  
 white-grey included - without transformer  
 Pendelleuchte mit Kugelgelenk - kürzbare Stange - Glas  
 GL2718CG Kreide-Weiß einbegriffen - ohne Trafo

Ref

4028.B3.14

#### Lamptype

QT12 GY6,35 (1) 50W 12V

#### Dimensions

Ø105xH110 - Bar 800

### 4028/.. - GUILIA C - M10

~12V 0,2810 0,5 m



pendant - glass GL2718CG white-grey included - without  
 transformer  
 Pendelleuchte - Glas GL2718CG Kreide-Weiß einbegriffen -  
 ohne Trafo

Ref

4028.14

#### Lamptype

QT12 GY6,35 (1) 50W 12V

#### Dimensions

Ø105xH110 - Bar 800

*build-up*  
*other lengths on request*  
*andere Längen auf Anfrage*



All M10 spotlights and pendants can be combined with bases (build-in & build-up) and Juba bases as preferred.  
 Alle M10 Aufbaustrahler und Pendelleuchten können mit Rosetten (In- & Aufbau) und Juba Basen nach Wahl kombiniert werden.

**GL2718CG/.. - GUILIA C spare glass**

IP20   



spare glass - ceramic grey  
 Ersatzglas - Grau keramisches

Ref

GL2718CG

**Dimensions**

↔ Ø106xH110

rod not included  
 Stange nicht einbegriffen

**4013.B1/.. - NOA PC - B1**

~230V

  IP20    0,9880  0,5 m  05.10.02 



pendant with swivel and build-up base - rod can be shortened - with transformer  
 Pendelleuchte mit Kugelgelenk und Aufbaurosette - kürzbare Stange - mit Trafo

Ref

4013.B1.14

4013.B1.16

**Lamptype**

 QR-CB 51 coolfit GU5,3/GX5,3 (1) 50W 12V

**Dimensions**

↔ Ø60xH250 - Bar 520

 Ø60xH90

build-up  
 use coolfit lamp  
 Coolfit-Lampe verwenden

**4013.B2/.. - NOA PC - B2**

~12V

  IP20    0,7810  0,5 m  05.10.02 



pendant with swivel and build-up base - rod can be shortened - without transformer  
 Pendelleuchte mit Kugelgelenk und Aufbaurosette - kürzbare Stange - ohne Trafo

Ref

4013.B2.14

4013.B2.16

**Lamptype**

 QR-CB 51 coolfit GU5,3/GX5,3 (1) 50W 12V

**Dimensions**

↔ Ø60xH250 - Bar 520

 Ø54xH60

build-up  
 use coolfit lamp  
 Coolfit-Lampe verwenden

**4013.B3/.. - NOA PC - B3**

~12V

  IP20    0,4665  0,5 m  05.10.02 



pendant with swivel - rod can be shortened - without transformer  
 Pendelleuchte mit Kugelgelenk - kürzbare Stange - ohne Trafo

Ref

4013.B3.14

4013.B3.16

**Lamptype**

 QR-CB 51 coolfit GU5,3/GX5,3 (1) 50W 12V

**Dimensions**

↔ Ø60xH250 - Bar 520

build-up  
 use coolfit lamp  
 Coolfit-Lampe verwenden

## INDOOR | Spots & pendants | NOA PC | NOA glass + alu

All M10 spotlights and pendants can be combined with bases (build-in & build-up) and Juba bases as preferred.  
Alle M10 Aufbaustrahler und Pendelleuchten können mit Rosetten (In- & Aufbau) und Juba Basen nach Wahl kombiniert werden.

### 4013../.. - NOA PC - M10

~12V



pendant - without transformer  
Pendelleuchte - ohne Trafo

#### Ref

4013.14

4013.16

#### Lamp type

QR-CB 51 coolfit GU5,3/GX5,3 (1) 50W 12V

#### Dimensions

↔ Ø60xH250 - Bar 520

#### build-up

other lengths on request - use coolfit lamp  
andere Längen auf Anfrage - Coolfit-Lampe verwenden

### 4014.B1../.. - NOA glass + alu - B1

~230V



pendant with swivel and build-up base - rod can be shortened - with transformer  
Pendelleuchte mit Kugelgelenk und Aufbaurosette - kürzbare Stange - mit Trafo

#### Ref

4014.B1.14

4014.B1.16

#### Lamp type

QR-CB 51 coolfit GU5,3/GX5,3 (1) 50W 12V

#### Dimensions

↔ Ø60xH250 - Bar 520

⤴ Ø60xH90

#### build-up

use coolfit lamp  
Coolfit-Lampe verwenden

### 4014.B2../.. - NOA glass + alu - B2

~12V



pendant with swivel and build-up base - rod can be shortened - without transformer  
Pendelleuchte mit Kugelgelenk und Aufbaurosette - kürzbare Stange - ohne Trafo

#### Ref

4014.B2.14

4014.B2.16

#### Lamp type

QR-CB 51 coolfit GU5,3/GX5,3 (1) 50W 12V

#### Dimensions

↔ Ø60xH250 - Bar 520

⤴ Ø54xH60

#### build-up

use coolfit lamp  
Coolfit-Lampe verwenden

### 4014.B3../.. - NOA glass + alu - B3

~12V



pendant with swivel - rod can be shortened - without transformer  
Pendelleuchte mit Kugelgelenk - kürzbare Stange - ohne Trafo

#### Ref

4014.B3.14

4014.B3.16

#### Lamp type

QR-CB 51 coolfit GU5,3/GX5,3 (1) 50W 12V

#### Dimensions

↔ Ø60xH250 - Bar 520

#### build-up

use coolfit lamp  
Coolfit-Lampe verwenden

All M10 spotlights and pendants can be combined with bases (build-in & build-up) and Juba bases as preferred.  
 Alle M10 Aufbaustrahler und Pendelleuchten können mit Rosetten (In- & Aufbau) und Juba Basen nach Wahl kombiniert werden.

**4014/.. - NOA - M10**

~12V     0,6630  0,5 m  05.10.02 



pendant - without transformer  
 Pendelleuchte - ohne Trafo

**Ref**

4014.14

**Lamptype**

 QR-CB 51 coolfit GU5,3/GX5,3 (1) 50W 12V

4014.16

**Dimensions**

 Ø60xH250 - Bar 520

*build-up*  
 other lengths on request - use coolfit lamp  
 andere Längen auf Anfrage - Coolfit-Lampe verwenden

**4015.B1/.. - NOA alu - B1**

~230V   IP20   0,9050  0,5 m  05.10.02 



pendant with swivel and build-up base - rod can be shortened - with transformer  
 Pendelleuchte mit Kugelgelenk und Aufbaurosette - kürzbare Stange - mit Trafo

**Ref**

4015.B1.14

**Lamptype**

 QR-CB 51 coolfit GU5,3/GX5,3 (1) 50W 12V

**Dimensions**

 Ø60xH250 - Bar 520

 Ø60xH90

*build-up*  
 use coolfit lamp  
 Coolfit-Lampe verwenden

**4015.B2/.. - NOA alu - B2**

~12V     0,7050  0,5 m  05.10.02 



pendant with swivel and build-up base - rod can be shortened - without transformer  
 Pendelleuchte mit Kugelgelenk und Aufbaurosette - kürzbare Stange - ohne Trafo

**Ref**

4015.B2.14

**Lamptype**

 QR-CB 51 coolfit GU5,3/GX5,3 (1) 50W 12V

**Dimensions**

 Ø60xH250 - Bar 520

 Ø54xH60

*build-up*  
 use coolfit lamp  
 Coolfit-Lampe verwenden

**4015.B3/.. - NOA alu - B3**

~12V     0,5210  0,5 m  05.10.02 



pendant with swivel - rod can be shortened - without transformer  
 Pendelleuchte mit Kugelgelenk - kürzbare Stange - ohne Trafo

**Ref**

4015.B3.14

**Lamptype**

 QR-CB 51 coolfit GU5,3/GX5,3 (1) 50W 12V

**Dimensions**

 Ø60xH250 - Bar 520

*build-up*  
 use coolfit lamp  
 Coolfit-Lampe verwenden

## INDOOR | Spots & pendants | NOA alu

All M10 spotlights and pendants can be combined with bases (build-in & build-up) and Juba bases as preferred.  
Alle M10 Aufbaustrahler und Pendelleuchten können mit Rosetten (In- & Aufbau) und Juba Basen nach Wahl kombiniert werden.

### 4015/.. - NOA alu - M10

~12V



pendant - without transformer  
Pendelleuchte - ohne Trafo

Ref

4015.14

#### Lamptype

QR-CB 51 coolfit GU5,3/GX5,3 (1) 50W 12V

#### Dimensions

Ø60xH250 - Bar 520

#### build-up

other lengths on request - use coolfit lamp  
andere Längen auf Anfrage - Coolfit-Lampe verwenden

### 4016.B1/.. - NOA alu - B1

~230V



pendant with swivel and build-up base - rod can be shortened - with transformer  
Pendelleuchte mit Kugelgelenk und Aufbaurosette - kürzbare Stange - mit Trafo

Ref

4016.B1.14

#### Lamptype

QR-CB 51 coolfit GU5,3/GX5,3 (1) 50W 12V

#### Dimensions

Ø60xH150 - Bar 520

Ø60xH90

#### build-up

use coolfit lamp  
Coolfit-Lampe verwenden

### 4016.B2/.. - NOA alu - B2

~12V



pendant with swivel and build-up base - rod can be shortened - without transformer  
Pendelleuchte mit Kugelgelenk und Aufbaurosette - kürzbare Stange - ohne Trafo

Ref

4016.B2.14

#### Lamptype

QR-CB 51 coolfit GU5,3/GX5,3 (1) 50W 12V

#### Dimensions

Ø60xH150 - Bar 520

Ø54xH60

#### build-up

use coolfit lamp  
Coolfit-Lampe verwenden

### 4016.B3/.. - NOA alu - B3

~12V



pendant with swivel - rod can be shortened - without transformer  
Pendelleuchte mit Kugelgelenk - kürzbare Stange - ohne Trafo

Ref

4016.B3.14

#### Lamptype

QR-CB 51 coolfit GU5,3/GX5,3 (1) 50W 12V

#### Dimensions

Ø60xH150 - Bar 520

#### build-up

use coolfit lamp  
Coolfit-Lampe verwenden

All M10 spotlights and pendants can be combined with bases (build-in & build-up) and Juba bases as preferred.  
 Alle M10 Aufbaustrahler und Pendelleuchten können mit Rosetten (In- & Aufbau) und Juba Basen nach Wahl kombiniert werden.

**4016/.. - NOA alu - M10**

~12V



pendant - without transformer  
 Pendelleuchte - ohne Trafo

Ref  
 4016.14

**Lamptype**

QR-CB 51 coolfit GU5,3/GX5,3 (1) 50W 12V

**Dimensions**

Ø60xH150 - Bar 520

*build-up*  
 other lengths on request - use coolfit lamp  
 andere Längen auf Anfrage - Coolfit-Lampe verwenden

**4017.B2/.. - NOA PC - B2**

~230V



pendant with swivel and build-up base - rod can be shortened  
 Pendelleuchte mit Kugelgelenk und Aufbaurosette - kürzbare Stange

Ref  
 4017.B2.14  
 4017.B2.16

**Lamptype**

mini lynx longlife E27 (1) 11W 230V

**Dimensions**

Ø60xH250 - Bar 520

Ø54xH60

*build-up*

**4017.B3/.. - NOA PC - B3**

~230V



pendant with swivel - rod can be shortened  
 Pendelleuchte mit Kugelgelenk - kürzbare Stange

Ref  
 4017.B3.14  
 4017.B3.16

**Lamptype**

mini lynx longlife E27 (1) 11W 230V

**Dimensions**

Ø60xH250 - Bar 520

*build-up*

**4017/.. - NOA PC - M10**

~230V



pendant  
 Pendelleuchte

Ref  
 4017.14  
 4017.16

**Lamptype**

mini lynx longlife E27 (1) 11W 230V

**Dimensions**

Ø60xH250 - Bar 520

*build-up*  
 other lengths on request  
 andere Längen auf Anfrage

## INDOOR | Spots & pendants | NOA glass + alu | NOA alu

All M10 spotlights and pendants can be combined with bases (build-in & build-up) and Juba bases as preferred.  
 Alle M10 Aufbaustrahler und Pendelleuchten können mit Rosetten (In- & Aufbau) und Juba Basen nach Wahl kombiniert werden.

### 4019.B2/.. - NOA glass + alu - B2

~230V



pendant with swivel and build-up base - rod can be shortened  
 Pendelleuchte mit Kugelgelenk und Aufbaurosette - kürzbare Stange

#### Ref

4019.B2.14  
 4019.B2.16

#### Lamptype

TC-DEL G24Q2 (1) 18W 230V

#### Dimensions

Ø60xH250 - Bar 520  
 Ø54xH60

build-up

### 4019.B3/.. - NOA glass + alu - B3

~230V



pendant with swivel - rod can be shortened  
 Pendelleuchte mit Kugelgelenk - kürzbare Stange

#### Ref

4019.B3.14  
 4019.B3.16

#### Lamptype

TC-DEL G24Q2 (1) 18W 230V

#### Dimensions

Ø60xH250 - Bar 520

build-up

### 4019/.. - NOA glass + alu - M10

~230V



pendant  
 Pendelleuchte

#### Ref

4019.14  
 4019.16

#### Lamptype

TC-DEL G24Q2 (1) 18W 230V

#### Dimensions

Ø60xH250 - Bar 520

build-up

other lengths on request  
 andere Längen auf Anfrage

### 4021.B1/.. - NOA alu - B1

~230V



pendant with swivel and build-up base - with transformer  
 Pendelleuchte mit Kugelgelenk und Aufbaurosette - mit Trafo

#### Ref

4021.B1.14

#### Lamptype

QR-CB 51 coolfit GU5,3/GX5,3 (1) 50W 12V

#### Dimensions

Ø60xH250 - Bar 100  
 Ø60xH90

build-up

use coolfit lamp  
 Coolfit-Lampe verwenden

All M10 spotlights and pendants can be combined with bases (build-in & build-up) and Juba bases as preferred.  
 Alle M10 Aufbaustrahler und Pendelleuchten können mit Rosetten (In- & Aufbau) und Juba Basen nach Wahl kombiniert werden.

3071.G9/.. - SPAZIO - B2

~230V



pendant with swivel and build-up base - rod can be shortened  
 Pendelleuchte mit Kugelgelenk und Aufbaurosette - kürzbare Stange

Ref

3071.G9.14

Lamp type

☑ QT14 G9 (1) 75W 230V  
 or ☑ CFL G9 (1) 7W 230V

Dimensions

↔ Ø200xH100 - Bar 800  
 ⚙ Ø54xH60

build-up





**VOLTA**

1959A/.. P.167



**VOLTA**

1959B/.. P.167



**JUBA**

810/.. P.166



**JUBA**

817/.. P.168



**OVALE BOX**

927/.. P.201



**TEXO**

652/.. P.171



**SQUARE**

935/.. P.173



**SQUARE**

943/.. P.174



**SQUARE SALSA**

993/.. P.177



**RONDO BOX**

821/.. P.202



**ZOOM TWIST**

862A/.. P.178



**ZOOM**

899.A/.. P.182



**ZOOM**

920.A/.. P.182



**ZOOM**

900.A/.. P.182



**RONDO CLICK**

631.35/.. P.206



**COSMOS**

600.80/.. P.183



**ZOOM CLICK**

602.230V.45/.. P.184



**ZOOM CLICK VERA**

613.75/.. P.187



**ZOOM CLICK VOLTA**

619.AR70.45/.. P.191



**CUPIDO**

624.AR70/.. P.210



**CUBIC**

979/.. P.193



**CUBIC**

982LED/.. P.194



**CUBIC**

983LED/.. P.195



**CUBIC**

984LED/.. P.195



**PLAZA**

1287/.. P.213



**TITUS**

995/.. P.211



**TITUS**

914/.. P.196



**TITUS**

1901/.. P.196



**TITUS**

1902/.. P.197



**STAR**

986/.. P.213.



**BASE 4**

919/.. P.197



**CALYPSO**

972/.. P.198



**MAMBO**

3052/.. P.200



**STRIPE**

646/.. P.200



**RINGO**

985.A.230V/.. P.214



**MONET**

640.200/.. P.198



**MONET**

640.400/.. P.199



**MONET**

641.SL335/.. P.199



**MONET**

642.250/.. P.212



**SIRIO**

1293/.. P.215





## INDOOR | Bases

BASE 4	197
CALYPSO	198
COSMOS	183,184
CUBIC	193, 194, 195
CUPIDO	207 - 211
JUBA + JAZZ	166
JUBA	167 - 170
MAMBO	200
MONET	198, 199
MONET ROND	212
MONET STRIP	199
OVALE BOX	201, 202
PLAZA	213
RINGO	213, 214, 215
RONDO BOX	202, 203, 204
RONDO CLICK	205 - 206
SIRIO	215
SQUARE	172 - 176
SQUARE SALSA	177
STAR	213
STRIPE	200, 201
TEXO	171, 172
TITUS	195, 196, 197
TITUS Round	211, 212
VOLTA	166
VOLTA + JUBA	167
ZOOM	180, 181, 182
ZOOM CLICK	184 - 192
ZOOM TWIST	178



810/.. - JUBA + JAZZ - M10

~230V   IP20     0,4463  0,5 m  05.10.02 



ceiling light - jazz spotlight 5cm included - with transformer  
Deckenleuchte - Spot jazz 5cm einbegriffen - mit Trafo

**Ref**

810.1  
810.2  
810.4  
810.7  
810.11  
810.13  
810.16

**Lamptype**

◁ QR-CB 51 GU5,3/GX5,3 (1) 50W 12V

**Dimensions**

↔ L100xB55xH143

⌞ L100xB55xH40

build-up  
60VA

815/.. - JUBA + JAZZ - M10

~230V   IP20     0,7886  0,5 m  05.10.02 



ceiling light - jazz spotlight 5 - 10cm included - with transformer  
Deckenleuchte - Spot jazz 5 - 10cm einbegriffen - mit Trafo

**Ref**

815.1  
815.2  
815.4  
815.7  
815.11  
815.13  
815.16

**Lamptype**

◁ QR-CB 51 GU5,3/GX5,3 (2) 50W 12V

**Dimensions**

↔ L200xB55xH193

⌞ L200xB55xH40

build-up  
105VA

816/.. - JUBA + JAZZ - M10

~230V   IP20     1,2711  0,5 m  05.10.02 



ceiling light - jazz spotlight 5 - 10 - 15cm included - with transformer  
Deckenleuchte - Spot jazz 5 - 10 - 15cm einbegriffen - mit Trafo

**Ref**

816.1  
816.2  
816.4  
816.7  
816.11  
816.13  
816.16

**Lamptype**

◁ QR-CB 51 GU5,3/GX5,3 (3) 50W 12V

**Dimensions**

↔ L320xB55xH243

⌞ L320xB55xH40

build-up  
60VA + 105VA

1957/.. - VOLTA

~12V   IP20     05.10.02 



ceiling light - without transformer  
Deckenleuchte - ohne Trafo

**Ref**

1957.1M  
1957.7  
1957.10  
1957.13  
1957.14  
1957.23

**Lamptype**

◁ QR-LP70 BA15d (1) 50W 12V

**Dimensions**

↔ Ø60xH160

⌞ Ø60

build-up

1959A/.. - VOLTA + JUBA 1

~230V   IP20     



build-up ceiling or wall light - with transformer  
Decken- oder Wandleuchte für Aufbau - mit Trafo

**Lamp type**

QR-LP70 BA15d (1) 50W 12V

**Dimensions**

L100xB55xH160

L100xB55

**Ref**

- 1959A.1M
- 1959A.7
- 1959A.10
- 1959A.13
- 1959A.14
- 1959A.23

build-up  
60VA

1959B/.. - VOLTA + JUBA 2

~230V   IP20      



build-up ceiling or wall light - with transformer  
Decken- oder Wandleuchte für Aufbau - mit Trafo

**Lamp type**

QR-LP70 BA15d (2) 50W 12V

**Dimensions**

L200xB55xH160

L200xB55

**Ref**

- 1959B.1M
- 1959B.7
- 1959B.10
- 1959B.13
- 1959B.14
- 1959B.23

build-up  
105VA

000B3/.. - JUBA supplement SWIVEL

IP20   



supplement - additional cost for drilling the holes for pendant with swivel  
Supplement - zusätzliche Kosten für Ausbohrung Löcher für Pendelleuchte mit Kugelgelenk

**Ref**

000B3

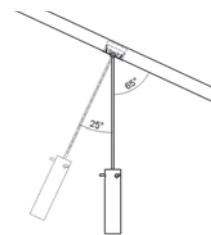
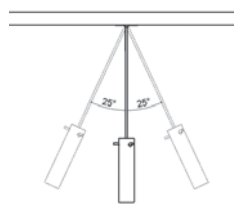

807/.. - JUBA - M10

~230V   IP20    



ceiling light without spotlight or pendant - 10cm - with transformer  
Deckenleuchte ohne Spot oder Hängelampe - 10cm - mit Trafo

**Dimensions**

L100xB55xH40

**Ref**

- 807.1
- 807.1M
- 807.2
- 807.4
- 807.7
- 807.11
- 807.13
- 807.14
- 807.16

build-up  
60VA

808/.. - JUBA - M10

~230V   IP20    0,4390 



ceiling light without spotlight or pendant - 20cm - with transformer  
Deckenleuchte ohne Spot oder Hängelampe - 20cm - mit Trafo

**Dimensions**





↔ L200xB55xH40

**Ref**

- 808.1
- 808.1M
- 808.2
- 808.4
- 808.7
- 808.11
- 808.13
- 808.14
- 808.16
- 808.23

build-up  
105VA

809/.. - JUBA - M10

~230V   IP20    0,8111 



ceiling light without spotlight or pendant - 32cm - with transformer  
Deckenleuchte ohne Spot oder Hängelampe - 32cm - mit Trafo

**Dimensions**

↔ L320xB55xH40

**Ref**

- 809.1
- 809.1M
- 809.2
- 809.4
- 809.7
- 809.11
- 809.13
- 809.14
- 809.16

build-up  
60VA + 105VA

817/.. - JUBA - M10

~230V   IP20    1,1111 

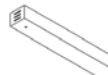

ceiling light without spotlight or pendant - 60cm - with transformer  
Deckenleuchte ohne Spot oder Hängelampe - 60cm - mit Trafo

**Dimensions**

↔ L600xB50xH40

**Options**

000B3/.. - JUBA supplement SWIVEL

**Ref**

- 817.1
- 817.1M
- 817.2
- 817.4
- 817.7
- 817.11
- 817.13
- 817.14
- 817.16

build-up  
60VA + 105VA

JUBA

~230V



IP20



ceiling light without spotlight or pendant - with transformer  
Deckenleuchte ohne Spot oder Hängelampe - mit Trafo

Dimensions

↔ B50xH40

Colour	818/..	819/..
	L 900	L 1200
1		
1M		
2		
4		
7		
11		
13		
14		
16		



**build-up**  
2x105VA - mention the number of holes!  
Zahl der Löcher erwähnen!

JUBA

~230V



IP20



ceiling light without spotlight or pendant - with transformer  
Deckenleuchte ohne Spot oder Hängelampe - mit Trafo

Dimensions

↔ B50xH40

Colour	811/..	812/..	813/..
	L 1400	L 1500	L 1600
1			
1M			
2			
4			
7			
11			
14			
16			



**build-up**  
2x105VA - mention the number of holes!  
Zahl der Löcher erwähnen!



814/.. - JUBA

~230V



IP20



ceiling light without spotlight or pendant - with transformer  
Deckenleuchte ohne Spot oder Hängelampe - mit Trafo

Dimensions

↔ B45xH45

Colour	814.A/..	814.B/..	814.C/..	814.D/..	814.E/..	814.F/..
	L 1800	L 2000	L 2250	L 2500	L 2750	L 3000
1						
1M						
14						

build-up

2x105VA - include drawing with the number of holes!  
Zeichnung mit Zahl der Löcher beifügen!

TR60VAMIN/.. - MIN TRANSFO 60VA

IP20



cost electronic transformer 60VA deducted  
Kosten elektronischer Trafo 60VA abgezogen

Ref

TR60VAMIN

TR60VAPLUS/.. - SUPPLEMENT TRANSFO 60VA

IP20



supplement - electronic transformer 60VA + assembly  
Supplement - elektronischer Trafo 60VA + Montage

Ref

TR60VAPLUS

TR105VAMIN/.. - MIN TRANSFO 105VA

IP20   0,0010 

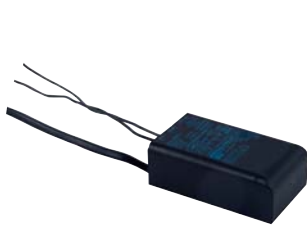

cost electronic transformer 105VA deducted  
Kosten elektronischer Trafo 105VA abgezogen

Ref  
TR105VAMIN

TR105VAPLUS/.. - SUPPLEMENT TRANSFO 105VA

IP20   0,0946 



supplement - electronic transformer 105VA + assembly  
Supplement - elektronischer Trafo 105VA + Montage

Ref  
TR105VAPLUS

651/.. - TEXO - M10

~230V  IP20    0,2031 



build-up rosette - no room for transformer  
Aufbaurosette - kein Platz für Trafo

Dimensions

↔ L85xB85xH30  
⌞ L60xB60

Ref  
651.1  
651.1M  
651.2  
651.4  
651.5  
651.7  
651.11  
651.13  
651.14  
651.16

**build-up**  
230V - spot to be ordered separately  
Strahler separat zu bestellen

652/.. - TEXO - M10

~230V  IP20    0,4412 



ceiling light - no room for transformer  
Deckenleuchte - kein Platz für Trafo

Dimensions

↔ L200xB85xH30  
⌞ L175xB60

Ref  
652.1  
652.1M  
652.2  
652.4  
652.5  
652.7  
652.11  
652.13  
652.14  
652.16

**build-up**  
230V - spots to be ordered separately  
Strahler separat zu bestellen

653/.. - TEXO - M10

~230V

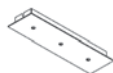

ceiling light - no room for transformer  
Deckenleuchte - kein Platz für Trafo

**Dimensions**

↔ L300xB85xH30

⌞ L275xB60

**Ref**

653.1  
653.1M  
653.2  
653.4  
653.5  
653.7  
653.11  
653.13  
653.14  
653.16

*build-up*  
230V - spots to be ordered separately  
Strahler separat zu bestellen

654/.. - TEXO - M10

~230V

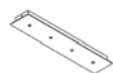

ceiling light - no room for transformer  
Deckenleuchte - kein Platz für Trafo

**Dimensions**

↔ L400xB85xH30

⌞ L375xB60

**Ref**

654.1  
654.1M  
654.2  
654.4  
654.5  
654.7  
654.11  
654.13  
654.14  
654.16

*build-up*  
230V - spots to be ordered separately  
Strahler separat zu bestellen

931/.. - SQUARE 12V - M10

~230V



ceiling light - spot to be ordered separately - with transformer  
Deckenleuchte - Strahler separat zu bestellen - mit Trafo

**Dimensions**

↔ L125xB125xH33

⌞ L110xB110

**Ref**

931.1.1  
931.1M.1M  
931.11.11  
931.14.2  
931.14.11  
931.16.2  
931.16.16

*build-up*  
60VA

933/.. - SQUARE 12V - M10

~230V



ceiling light - spots to be ordered separately - with transformer  
Deckenleuchte - Strahler separat zu bestellen - mit Trafo

**Dimensions**

↔ L170xB170xH42

⌞ L145xB145

**Ref**

933.1.1  
933.1M.1M  
933.11.11  
933.14.2  
933.14.11  
933.16.2  
933.16.16

*build-up*  
105VA



935/.. - SQUARE 12V - M10

~230V   IP20    1,5724 

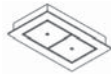

ceiling light - spots to be ordered separately - with transformer  
Deckenleuchte - Strahler separat zu bestellen - mit Trafo

**Dimensions**

↔ L275xB170xH42

⌞ L250xB145

**Ref**

- 935.1.1
- 935.1M.1M
- 935.11.11
- 935.14.2
- 935.14.11
- 935.16.2
- 935.16.16

build-up  
105VA

937/.. - SQUARE 12V - M10

~230V   IP20    1,7958 



ceiling light - spots to be ordered separately - with transformer  
Deckenleuchte - Strahler separat zu bestellen - mit Trafo

**Dimensions**

↔ L275xB170xH42

⌞ L250xB145

**Ref**

- 937.1.1
- 937.1M.1M
- 937.11.11
- 937.13.2
- 937.14.2
- 937.14.11
- 937.16.2
- 937.16.16

build-up  
2x105VA

939/.. - SQUARE 12V - M10

~230V   IP20    2,1991 

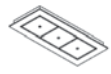

ceiling light - spots to be ordered separately - with transformer  
Deckenleuchte - Strahler separat zu bestellen - mit Trafo

**Dimensions**

↔ L380xB170xH42

⌞ L355xB147

**Ref**

- 939.1.1
- 939.1M.1M
- 939.11.11
- 939.14.2
- 939.14.11
- 939.16.2
- 939.16.16

build-up  
60VA + 105VA

941/.. - SQUARE 12V - M10

~230V   IP20    2,0003 



ceiling light - spots to be ordered separately - with transformer  
Deckenleuchte - Strahler separat zu bestellen - mit Trafo

**Dimensions**

↔ L380xB170xH42

⌞ L355xB147

**Ref**

- 941.1.1
- 941.1M.1M
- 941.11.11
- 941.13.2
- 941.14.2
- 941.14.11
- 941.16.2
- 941.16.16

build-up  
3x105VA

943/.. - SQUARE 12V - M10

~230V   IP20    2,5649 



ceiling light - spots to be ordered separately - with transformer  
Deckenleuchte - Strahler separat zu bestellen - mit Trafo

**Dimensions**

↔ L275xB275xH42

⊣ L260xB260

**Ref**

- 943.1.1
- 943.1M.1M
- 943.11.11
- 943.14.2
- 943.14.11
- 943.16.2
- 943.16.16

build-up  
2x105VA

750/.. - SQUARE 12V - M10

~230V   IP20    2,3165 

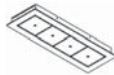

ceiling light - spots to be ordered separately - with transformer  
Deckenleuchte - Strahler separat zu bestellen - mit Trafo

**Dimensions**

↔ L485xB170xH42

⊣ L460xB144

**Ref**

- 750.1.1
- 750.1M.1M
- 750.11.11
- 750.14.2
- 750.14.11
- 750.16.2

build-up  
2x105VA

751/.. - SQUARE 12V - M10

~230V   IP20    1,9113 



ceiling light - spots to be ordered separately - with transformer  
Deckenleuchte - Strahler separat zu bestellen - mit Trafo

**Dimensions**

↔ L485xB170xH42





⊣ L460xB144

**Ref**

- 751.1.1
- 751.1M.1M
- 751.11.11
- 751.14.2
- 751.14.11
- 751.16.2

build-up  
4x105VA

932.220/.. - SQUARE 230V - M10

~230V  IP20    0,5159 



ceiling light - spot to be ordered separately  
Deckenleuchte - Strahler separat zu bestellen

**Dimensions**

↔ L125xB125xH33

⊣ L110xB110

**Ref**

- 932.220.1.1
- 932.220.1M.1M
- 932.220.11.11
- 932.220.14.2
- 932.220.14.11
- 932.220.16.2
- 932.220.16.16

build-up

934.220/.. - SQUARE 230V - M10

~230V  IP20    0,8550 



ceiling light - spots to be ordered separately  
Deckenleuchte - Strahler separat zu bestellen

**Dimensions**

↔ L170xB170xH29-42

⊣ L145xB145

**Ref**

- 934.220.1.1
- 934.220.1M.1M
- 934.220.11.11
- 934.220.14.2
- 934.220.14.11
- 934.220.16.2
- 934.220.16.16

**build-up**  
16 matt gold = height 42  
16 Mattgold = Höhe 42

936.220/.. - SQUARE 230V - M10

~230V  IP20    1,3831 

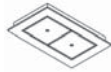

ceiling light - spots to be ordered separately  
Deckenleuchte - Strahler separat zu bestellen

**Dimensions**

↔ L275xB170xH29-42

⊣ L250xB145

**Ref**

- 936.220.1.1
- 936.220.1M.1M
- 936.220.11.11
- 936.220.14.2
- 936.220.14.11
- 936.220.16.2
- 936.220.16.16

**build-up**  
16 matt gold = height 42  
16 Mattgold = Höhe 42

938.220/.. - SQUARE 230V - M10

~230V  IP20    1,3750 



ceiling light - spots to be ordered separately  
Deckenleuchte - Strahler separat zu bestellen

**Dimensions**

↔ L275xB170xH29-42

⊣ L250xB145

**Ref**

- 938.220.1.1
- 938.220.1M.1M
- 938.220.11.11
- 938.220.14.2
- 938.220.14.11
- 938.220.16.2
- 938.220.16.16

**build-up**  
16 matt gold = height 42  
16 Mattgold = Höhe 42

940.220/.. - SQUARE 230V - M10

~230V  IP20    1,9530 

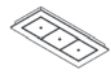

ceiling light - spots to be ordered separately  
Deckenleuchte - Strahler separat zu bestellen

**Dimensions**

↔ L380xB170xH29-42

⊣ L355xB145

**Ref**

- 940.220.1.1
- 940.220.1M.1M
- 940.220.11.11
- 940.220.14.2
- 940.220.14.11
- 940.220.16.2
- 940.220.16.16

**build-up**  
16 matt gold = height 42  
16 Mattgold = Höhe 42

942.220/.. - SQUARE 230V - M10

~230V  IP20    1,9457 



ceiling light - spots to be ordered separately  
Deckenleuchte - Strahler separat zu bestellen

**Dimensions**

↔ L380xB170xH29-42

⌈ L355xB145

**Ref**

- 942.220.1.1
- 942.220.1M.1M
- 942.220.11.11
- 942.220.14.2
- 942.220.14.11
- 942.220.16.2
- 942.220.16.16

**build-up**  
16 matt gold = height 42  
16 Mattgold = Höhe 42

944.220/.. - SQUARE 230V - M10

~230V  IP20    2,2246 



ceiling light - spots to be ordered separately  
Deckenleuchte - Strahler separat zu bestellen

**Dimensions**

↔ L275xB275xH29-42

⌈ L250xB250

**Ref**

- 944.220.1.1
- 944.220.1M.1M
- 944.220.11.11
- 944.220.14.2
- 944.220.14.11
- 944.220.16.2
- 944.220.16.16

**build-up**  
16 matt gold = height 42  
16 Mattgold = Höhe 42

752.220/.. - SQUARE 230V - M10

~230V  IP20    4,2260 



ceiling light - spots to be ordered separately  
Deckenleuchte - Strahler separat zu bestellen

**Dimensions**

↔ L485xB170xH29-42





⌈ L460xB144

**Ref**

- 752.220.1.1
- 752.220.1M.1M
- 752.220.11.11
- 752.220.14.2
- 752.220.14.11
- 752.220.16.2

**build-up**  
16 matt gold = height 42  
16 Mattgold = Höhe 42

753.220/.. - SQUARE 230V - M10

~230V  IP20    2,3900 



ceiling light - spots to be ordered separately  
Deckenleuchte - Strahler separat zu bestellen

**Dimensions**

↔ L485xB170xH29-42

⌈ L460xB144

**Ref**

- 753.220.1.1
- 753.220.1M.1M
- 753.220.11.11
- 753.220.14.2
- 753.220.14.11
- 753.220.16.2

**build-up**  
16 matt gold = height 42  
16 Mattgold = Höhe 42

991/.. - SQUARE SALSA

~230V   IP20    1,7423  0,5 m  05.10.02  



ceiling light - directional - with transformer  
Deckenleuchte - schwenkbar - mit Trafo

Ref

991.14.11

Lamp type

◁ QR-CB 51 GU5,3/GX5,3 (1) 50W 12V

991.16.2

991.16.16

Dimensions

↔ L170xB170xH150

↕ L110xB110

build-up  
60VA

992/.. - SQUARE SALSA

~230V   IP20    1,7917  0,5 m  05.10.02  



ceiling light - directional - with transformer  
Deckenleuchte - schwenkbar - mit Trafo

Ref

992.14.11

Lamp type

◁ QR-CB 51 GU5,3/GX5,3 (2) 50W 12V

992.16.2

992.16.16

Dimensions

↔ L275xB170xH150

↕ L250xB145

build-up  
105VA

993/.. - SQUARE SALSA

~230V   IP20    0,8967  0,5 m  05.10.02  



ceiling light - directional - with transformer  
Deckenleuchte - schwenkbar - mit Trafo

Ref

993.14.11

Lamp type

◁ QR-CB 51 GU5,3/GX5,3 (3) 50W 12V

993.16.2

993.16.16

Dimensions

↔ L380xB170xH150

↕ L355xB145

build-up  
60VA+105VA

994/.. - SQUARE SALSA

~230V   IP20    1,0070  0,5 m  05.10.02  



ceiling light - directional - with transformer  
Deckenleuchte - schwenkbar - mit Trafo

Ref

994.14.11

Lamp type

◁ QR-CB 51 GU5,3/GX5,3 (4) 50W 12V

994.16.2

994.16.16

Dimensions

↔ L275xB275xH150

↕ L250xB250

build-up  
2x105VA

861A/.. - ZOOM TWIST

~12V



ceiling light - spot included - without transformer  
Deckenleuchte - Strahler einbegriffen - ohne Trafo

Ref  
861A.40

Lamp type

◁ QR-CB 51 GU5,3/GX5,3 (1) 50W 12V

Dimensions

↔ L89,5xB89,5xH110

⌞ L72xB72

build-up

862A/.. - ZOOM TWIST

~230V



ceiling light - spots included - with transformer  
Deckenleuchte - Strahler einbegriffen - mit Trafo

Ref  
862A.40

Lamp type

◁ QR-CB 51 GU5,3/GX5,3 (2) 50W 12V

Dimensions

↔ L285xB163xH110

⌞ L260xB138

build-up

105VA

863A/.. - ZOOM TWIST

~230V



ceiling light - spots included - with transformer  
Deckenleuchte - Strahler einbegriffen - mit Trafo

Ref  
863A.40

Lamp type

◁ QR-CB 51 GU5,3/GX5,3 (3) 50W 12V

Dimensions

↔ L410xB163xH110

⌞ L383xB138

build-up

60VA+105VA

864A/.. - ZOOM TWIST

~230V



ceiling light - spots included - with transformer  
Deckenleuchte - Strahler einbegriffen - mit Trafo

Ref  
864A.40

Lamp type

◁ QR-CB 51 GU5,3/GX5,3 (4) 50W 12V

Dimensions

↔ L285xB285xH110

⌞ L262xB262

build-up

2x105VA



LALANDE  
JELLEN

CHATEAU  
POMEROL

CANON

LABOURGNE  
MAGNUMA

CHATEAU  
MAGNUMA

CHATEAU  
MAGNUMA

CHATEAU  
MAGNUMA

CHATEAU  
MAGNUMA

CHATEAU  
MAGNUMA

CHATEAU  
MAGNUMA

CHATEAU  
MAGNUMA

CHATEAU  
MAGNUMA

CHATEAU  
MAGNUMA

CHATEAU  
MAGNUMA

CHATEAU  
MAGNUMA



856/.. - ZOOM - M10

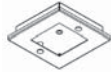

ceiling light - spot to be ordered separately - without transformer  
Deckenleuchte - Strahler separat zu bestellen - ohne Trafo

**Dimensions**

↔ L89,5xB89,5xH22

⌈ L70xB70

**Ref**

856.1

856.4

856.7

856.16

856.40

build-up

857/.. - ZOOM - M10



ceiling light - spot to be ordered separately - without transformer  
Deckenleuchte - Strahler separat zu bestellen - ohne Trafo

**Dimensions**

↔ L89,5xB89,5xH45

⌈ L70xB70

**Ref**

857.1

857.4

857.7

857.16

857.40

build-up

858/.. - ZOOM - M10



ceiling light - spot to be ordered separately - with transformer  
Deckenleuchte - Strahler separat zu bestellen - mit Trafo

**Dimensions**

↔ L89,5xB89,5xH45

⌈ L70xB70

**Ref**

858.1

858.4

858.7

858.13

858.16

858.40

build-up  
60VA

859/.. - ZOOM



downlight - without transformer  
Einbaustrahler - ohne Trafo

**Lamp type**

⊲ QR-CB 51 GU5,3/GX5,3 (1) 50W 12V

**Dimensions**

↔ L89,5xB89,5xH55

⌈ 72x72 ⌋ 75

**Ref**

859.1

859.4

859.7

859.16

859.40

build-in



860../.. - ZOOM - M10



ceiling light - spot to be ordered separately - without transformer  
Deckenleuchte - Strahler separat zu bestellen - ohne Trafo

**Dimensions**

↔ L89,5xB89,5xH55

📏 72x72 ⚖️ 75

**Ref**

- 860.1
- 860.4
- 860.7
- 860.16
- 860.40

build-in

896.A../.. - ZOOM BOX - M10



ceiling light - spots to be ordered separately - with transformer  
Deckenleuchte - Strahler separat zu bestellen - mit Trafo

**Dimensions**

↔ L150xB150xH50

📏 L125xB125

**Ref**

- 896.A.1
- 896.A.4
- 896.A.7
- 896.A.16
- 896.A.40

build-up  
105VA

897.A../.. - ZOOM - M10

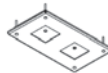

ceiling light - spots to be ordered separately - with transformer  
Deckenleuchte - Strahler separat zu bestellen - mit Trafo

**Dimensions**

↔ L285xB163xH50

📏 L260xB138

**Ref**

- 897.A.1
- 897.A.4
- 897.A.7
- 897.A.11
- 897.A.16
- 897.A.40

build-up  
105VA

898.A../.. - ZOOM - M10



ceiling light - spots to be ordered separately - with transformer  
Deckenleuchte - Strahler separat zu bestellen - mit Trafo

**Dimensions**

↔ L410xB163xH50

📏 L383xB138

**Ref**

- 898.A.1
- 898.A.4
- 898.A.7
- 898.A.11
- 898.A.16
- 898.A.40

build-up  
60VA + 105VA

899.A/.. - ZOOM - M10

~230V   IP20    2.5860 



ceiling light - spots to be ordered separately - with transformer  
Deckenleuchte - Strahler separat zu bestellen - mit Trafo

**Dimensions**

↔ L285xB285xH50

⤴ L262xB262

**Ref**

- 899.A.1
- 899.A.4
- 899.A.7
- 899.A.16
- 899.A.40

build-up  
2x105VA

920.A/.. - ZOOM - M10

~230V    IP20    5,8467  0,5 m  05.10.50 



ceiling light without spotlight or pendant - with transformer - with magnetic gear  
Deckenleuchte ohne Spot oder Hängelampe - mit Trafo - mit magnetischem Vorschaltgerät

**Lamptype**

☑ TC-F 2G10 (1) 36W 230V

**Dimensions**

↔ L400xB400xH55

⤴ L360xB360

**Ref**

- 920.A.1
- 920.A.16
- 920.A.40

build-up  
2x105VA - possible to order spots separately  
möglich um Strahler separat zu bestellen

900.A/.. - ZOOM - M10

  IP20    2,7300 

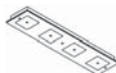

ceiling light - spots to be ordered separately - without transformer  
Deckenleuchte - Strahler separat zu bestellen - ohne Trafo

**Dimensions**

↔ L650xB160xH50

⤴ L620xB120

**Ref**

- 900.A.1
- 900.A.4
- 900.A.7
- 900.A.16
- 900.A.40

build-up

901.A/.. - ZOOM - M10

  IP20    0,7000 

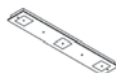

ceiling light - spots to be ordered separately - without transformer  
Deckenleuchte - Strahler separat zu bestellen - ohne Trafo

**Dimensions**

↔ L900xB160xH50

⤴ L870xB120

**Ref**

- 901.A.1
- 901.A.4
- 901.A.7
- 901.A.16
- 901.A.40

build-up

599.45/.. - COSMOS

~230V  IP20   0,2480 



ceiling light for build-in cassette SCS - no room for transformer  
Deckenleuchte für Einbaukassette SCS - kein Platz für Trafo

**Dimensions**

↔ L100xB100xH45

⌘ L100xB100

**Options**

CASVOLTA - ZERO - RIGA PLEXI

**Ref**

599.45.1  
599.45.1M  
599.45.2  
599.45.11  
599.45.14

build-up  
230V

599.ZT.80/.. - COSMOS

  IP20   0,3440 



ceiling light for build-in cassette SCS - without transformer  
Deckenleuchte für Einbaukassette SCS - ohne Trafo

**Dimensions**

↔ L100xB100xH80

⌘ L100xB100

**Options**

ALLE CASSETTES SQUARE CLICK SYSTEM 12V

**Ref**

599.ZT.80.1  
599.ZT.80.1M  
599.ZT.80.2  
599.ZT.80.11  
599.ZT.80.14

build-up

599.230V.80/.. - COSMOS

~230V  IP20   0,4680 



ceiling light for build-in cassette SCS  
Deckenleuchte für Einbaukassette SCS

**Dimensions**

↔ L100xB100xH80

⌘ L100xB100

**Options**

ALLE CASSETTES SQUARE CLICK SYSTEM 230V

**Ref**

599.230V.80.1  
599.230V.80.1M  
599.230V.80.2  
599.230V.80.11  
599.230V.80.14

build-up

600.80/.. - COSMOS cas Vera

~230V  IP20   0,5657  1 m  05.10.02 



ceiling light  
Deckenleuchte

**Lamptype**

⦿ TC-HSE E27 (1) 11W

230V

**Dimensions**

↔ L100xB100xH155

⌘ L100xB100xH75

**Ref**

600.80.1  
600.80.1M  
600.80.1S  
600.80.2  
600.80.11  
600.80.11S  
600.80.14

build-up  
colour 1S - 11S = IP44  
Farbe 1S - 11S = IP44

600.ES63.45/.. - COSMOS cas Volta

~230V



ceiling light  
Deckenleuchte

Lamptype

QPAR64 GU10 (1) 75W

230V

Dimensions

L100xB100xH140

L100xB100xH45

Ref

600.ES63.45.1.40

600.ES63.45.1M

600.ES63.45.2.7

600.ES63.45.2.40

600.ES63.45.11.40

600.ES63.45.14.40

build-up

601.230V.45/.. - ZOOM CLICK

~230V



ceiling light for build-in cassette SCS  
Deckenleuchte für Einbaukassette SCS

Dimensions

L180xB180xH45

L140xB140

Options

CASVOLTA.ES50/.. - SCS SYSTEM

CASVOLTA.ES63/.. - SCS SYSTEM

CASZERO/.. - SCS SYSTEM

CASZEROB3/.. - SCS SYSTEM

Ref

601.230V.45.1

601.230V.45.1M

601.230V.45.2

601.230V.45.11

601.230V.45.14

build-up

601.230V.75/.. - ZOOM CLICK

~230V



ceiling light for build-in cassette SCS  
Deckenleuchte für Einbaukassette SCS

Dimensions

L180xB180xH75

L140xB140

Options

CAS DANA - VERA - VOLTA - ZERO - RIGA 230V

CAS SAMBA - ANKA - ROMA - CONGA - LIMBO 230V

CAS ZORBA - COMO - ALTO - OUZO 230V

Ref

601.230V.75.1

601.230V.75.1M

601.230V.75.2

601.230V.75.11

601.230V.75.14

build-up

602.230V.45/.. - ZOOM CLICK II

~230V

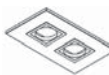

ceiling light for build-in cassette SCS  
Deckenleuchte für Einbaukassette SCS

Dimensions

L340xB200xH45

L270xB130

Options

CASVOLTA.ES50/.. - SCS SYSTEM

CASVOLTA.ES63/.. - SCS SYSTEM

CASZERO/.. - SCS SYSTEM

CASZEROB3/.. - SCS SYSTEM

Ref

602.230V.45.1

602.230V.45.1M

602.230V.45.2

602.230V.45.11

602.230V.45.14

build-up

602.230V.75/.. - ZOOM CLICK II

~230V  IP20    1,4800 



ceiling light for build-in cassette SCS  
Deckenleuchte für Einbaukassette SCS

**Dimensions**

↔ L340xB200xH75

⌞ L270xB130

**Options**

CAS DANA - VERA - VOLTA - ZERO - RIGA 230V  
CAS SAMBA - ANKA - ROMA - CONGA - LIMBO 230V  
CAS ZORBA - COMO - ALTO - OUZO 230V

**Ref**

602.230V.75.1  
602.230V.75.1M  
602.230V.75.2  
602.230V.75.11  
602.230V.75.14

build-up

603.230V.45/.. - ZOOM CLICK III

~230V  IP20    1,6256 



ceiling light for build-in cassette SCS  
Deckenleuchte für Einbaukassette SCS

**Dimensions**

↔ L480xB200xH45

⌞ L410xB130

**Options**

CASVOLTA.ES50/.. - SCS SYSTEM  
CASVOLTA.ES63/.. - SCS SYSTEM  
CASZERO/.. - SCS SYSTEM  
CASZEROB3/.. - SCS SYSTEM

**Ref**

603.230V.45.1  
603.230V.45.1M  
603.230V.45.2  
603.230V.45.11  
603.230V.45.14

build-up

603.230V.75/.. - ZOOM CLICK III

~230V  IP20    1,9224 



ceiling light for build-in cassette SCS  
Deckenleuchte für Einbaukassette SCS

**Dimensions**

↔ L480xB200xH75

⌞ L410xB130

**Options**



CAS DANA - VERA - VOLTA - ZERO - RIGA 230V  
CAS SAMBA - ANKA - ROMA - CONGA - LIMBO 230V  
CAS ZORBA - COMO - ALTO - OUZO 230V

**Ref**

603.230V.75.1  
603.230V.75.1M  
603.230V.75.2  
603.230V.75.11  
603.230V.75.14

build-up

604.230V.45/.. - ZOOM CLICK 4 in line

~230V  IP20   



ceiling light for build-in cassette SCS  
Deckenleuchte für Einbaukassette SCS

**Dimensions**

↔ L620xB200xH45

⌞ L550xB130

**Options**

CASVOLTA.ES50/.. - SCS SYSTEM  
CASVOLTA.ES63/.. - SCS SYSTEM  
CASZERO/.. - SCS SYSTEM  
CASZEROB3/.. - SCS SYSTEM

**Ref**

604.230V.45.1  
604.230V.45.1M  
604.230V.45.2  
604.230V.45.11  
604.230V.45.14

build-up

604.230V.75/.. - ZOOM CLICK 4 in line

~230V  IP20    0,7888 



ceiling light for build-in cassette SCS  
Deckenleuchte für Einbaukassette SCS

**Dimensions**

↔ L620xB200xH75

⌞ L550xB130

**Options**





CAS DANA - VERA - VOLTA - ZERO - RIGA 230V  
CAS SAMBA - ANKA - ROMA - CONGA - LIMBO 230V  
CAS ZORBA - COMO - ALTO - OUZO 230V

**Ref**

604.230V.75.1  
604.230V.75.1M  
604.230V.75.2  
604.230V.75.11  
604.230V.75.14

build-up

605.230V.45/.. - ZOOM CLICK IV

~230V  IP20    2,1816 



ceiling light for build-in cassette SCS  
Deckenleuchte für Einbaukassette SCS

**Dimensions**

↔ L340xB340xH45

⌞ L270xB270

**Options**

CASVOLTA.ES50/.. - SCS SYSTEM  
CASVOLTA.ES63/.. - SCS SYSTEM  
CASZERO/.. - SCS SYSTEM  
CASZEROB3/.. - SCS SYSTEM

**Ref**

605.230V.45.1  
605.230V.45.1M  
605.230V.45.2  
605.230V.45.11  
605.230V.45.14

build-up

605.230V.75/.. - ZOOM CLICK IV

~230V  IP20   



ceiling light for build-in cassette SCS  
Deckenleuchte für Einbaukassette SCS

**Dimensions**

↔ L340xB340xH75

⌞ L270xB270

**Options**

CAS DANA - VERA - VOLTA - ZERO - RIGA 230V  
CAS SAMBA - ANKA - ROMA - CONGA - LIMBO 230V  
CAS ZORBA - COMO - ALTO - OUZO 230V

**Ref**

605.230V.75.1  
605.230V.75.1M  
605.230V.75.2  
605.230V.75.11  
605.230V.75.14

build-up

611.75/.. - ZOOM CLICK + VERA

~230V  IP20    1,0118  0,5 m  05.10.02 



ceiling light  
Deckenleuchte

**Lamptype**

☞ TC-HSE E27 (1) 11W

230V

**Dimensions**

↔ L180xB180xH155

⌞ L140xB140

**Ref**

611.75.1  
611.75.1M  
611.75.2  
611.75.11  
611.75.14

build-up

612.75/.. - ZOOM CLICK + VERA

~230V



ceiling light  
Deckenleuchte

**Lamptype**

TC-HSE E27 (2) 11W

230V

**Dimensions**

L340xB200xH155

L270xB130

**Ref**

612.75.1

612.75.1M

612.75.2

612.75.11

612.75.14

build-up

613.75/.. - ZOOM CLICK + VERA

~230V

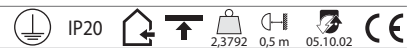

ceiling light  
Deckenleuchte

**Lamptype**

TC-HSE E27 (3) 11W

230V

**Dimensions**

L480xB200xH155

L410xB130

**Ref**

613.75.1

613.75.1M

613.75.2

613.75.11

613.75.14

build-up

614.75/.. - ZOOM CLICK + VERA

~230V



ceiling light  
Deckenleuchte

**Lamptype**

TC-HSE E27 (4) 11W

230V

**Dimensions**

L620xB200xH155

L550xB130

**Ref**

614.75.1

614.75.1M

614.75.2

614.75.11

614.75.14

build-up

615.75/.. - ZOOM CLICK + VERA

~230V

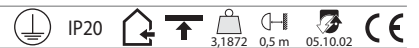

ceiling light  
Deckenleuchte

**Lamptype**

TC-HSE E27 (4) 11W

230V

**Dimensions**

L340xB340xH155

L260xB260

**Ref**

615.75.1

615.75.1M

615.75.2

615.75.11

615.75.14

build-up

**616.AR70.45/.. - ZOOM CLICK + VOLTA**

~230V   IP20     0,5 m  



ceiling light - cone Ø78 H85 - with transformer  
Deckenleuchte - Kelch Ø78 H85 - mit Trafo

**Lamptype**

 QR-LP70 BA15d (1) 50W 12V

**Dimensions**

 L180xB180xH130

 L140xB140

**Ref**

- 616.AR70.45.1.1
- 616.AR70.45.1M.1M
- 616.AR70.45.2.7
- 616.AR70.45.2.40
- 616.AR70.45.11.40
- 616.AR70.45.14.40

build-up  
60VA

**616.DICRO.45/.. - ZOOM CLICK + VOLTA**

~230V   IP20     0,5 m  



ceiling light - cone Ø65 H70 - with transformer  
Deckenleuchte - Kelch Ø65 H70 - mit Trafo

**Lamptype**

 QR-CB 51 coolfit GU5,3/GX5,3 (1) 35W 12V

**Dimensions**

 L180xB180xH115

 L140xB140

**Ref**

- 616.DICRO.45.1.1
- 616.DICRO.45.1M.1M
- 616.DICRO.45.2.7
- 616.DICRO.45.2.40
- 616.DICRO.45.11.40
- 616.DICRO.45.14.40

build-up  
60VA - use coolfit lamp  
Coolfit-Lampe verwenden

**616.ES50.45/.. - ZOOM CLICK + VOLTA**

~230V  IP20     1 m  



ceiling light - cone Ø65 H70  
Deckenleuchte - Kelch Ø65 H70

**Lamptype**

 QPAR 51 GU10 (1) 50W 230V  
or  QPAR 51 GU10 (1) 11W 230V

**Dimensions**

 L180xB180xH115

 L140xB140

**Ref**

- 616.ES50.45.1.1
- 616.ES50.45.1M.1M
- 616.ES50.45.2.7
- 616.ES50.45.2.40
- 616.ES50.45.11.40
- 616.ES50.45.14.40

build-up

**616.ES63.45/.. - ZOOM CLICK + VOLTA**

~230V  IP20     1 m  



ceiling light - cone Ø78 H85  
Deckenleuchte - Kelch Ø78 H85

**Lamptype**

 QPAR64 GU10 (1) 75W 230V

**Dimensions**

 L180xB180xH130

 L140xB140

**Ref**

- 616.ES63.45.1
- 616.ES63.45.1M.1M
- 616.ES63.45.2.7
- 616.ES63.45.2.40
- 616.ES63.45.11.40
- 616.ES63.45.14.40

build-up



617.AR70.45/.. - ZOOM CLICK + VOLTA

~230V   IP20     0,5 m  



ceiling light - cone Ø78 H85 - with transformer  
Deckenleuchte - Kelch Ø78 H85 - mit Trafo

**Lamptype**

QR-LP70 BA15d (2) 50W 12V

**Dimensions**

L340xB200xH130

L270xB130

**Ref**

- 617.AR70.45.1.1
- 617.AR70.45.1M.1M
- 617.AR70.45.2.7
- 617.AR70.45.2.40
- 617.AR70.45.11.40
- 617.AR70.45.14.40

build-up  
105VA

617.DICRO.45/.. - ZOOM CLICK + VOLTA

~230V   IP20     0,3954  0,5 m  



ceiling light - cone Ø65 H70 - with transformer  
Deckenleuchte - Kelch Ø65 H70 - mit Trafo

**Lamptype**

QR-CB 51 coolfit GU5,3/GX5,3 (2) 35W 12V

**Dimensions**

L340xB200xH115

L270xB130

**Ref**

- 617.DICRO.45.1.1
- 617.DICRO.45.1M.1M
- 617.DICRO.45.2.7
- 617.DICRO.45.2.40
- 617.DICRO.45.11.40
- 617.DICRO.45.14.40

build-up  
105VA - use coolfit lamp  
Coolfit-Lampe verwenden

617.ES50.45/.. - ZOOM CLICK + VOLTA

~230V  IP20     0,4033  1 m  



ceiling light - cone Ø65 H70  
Deckenleuchte - Kelch Ø65 H70

**Lamptype**

QPAR 51 GU10 (2) 50W 230V  
or QPAR 51 GU10 (2) 11W 230V

**Dimensions**

L340xB200xH115

L270xB130

**Ref**

- 617.ES50.45.1.1
- 617.ES50.45.1M.1M
- 617.ES50.45.2.7
- 617.ES50.45.2.40
- 617.ES50.45.11.40
- 617.ES50.45.14.40

build-up

617.ES63.45/.. - ZOOM CLICK + VOLTA

~230V  IP20     1 m  



ceiling light - cone Ø78 H85  
Deckenleuchte - Kelch Ø78 H85

**Lamptype**

QPAR64 GU10 (2) 75W 230V

**Dimensions**

L340xB200xH130

L270xB130

**Ref**

- 617.ES63.45.1.1
- 617.ES63.45.1M.1M
- 617.ES63.45.2.7
- 617.ES63.45.2.40
- 617.ES63.45.11.40
- 617.ES63.45.14.40

build-up

**618.AR70.45/.. - ZOOM CLICK + VOLTA**

~230V

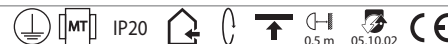

ceiling light - cone Ø78 H85 - with transformer  
Deckenleuchte - Kelch Ø78 H85 - mit Trafo

**Lamp type**

QR-LP70 BA15d (3) 50W 12V

**Dimensions**

L480xB200xH130

L410xB130

**Ref**

618.AR70.45.1.1  
618.AR70.45.1M.1M  
618.AR70.45.2.7  
618.AR70.45.2.40  
618.AR70.45.11.40  
618.AR70.45.14.40

build-up  
60VA+105VA

**618.DICRO.45/.. - ZOOM CLICK + VOLTA**

~230V

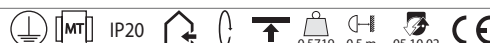

ceiling light - cone Ø65 H70 - with transformer  
Deckenleuchte - Kelch Ø65 H70 - mit Trafo

**Lamp type**

QR-CB 51 coolfit GU5,3/GX5,3 (3) 35W 12V

**Dimensions**

L480xB200xH115

L410xB130

**Ref**

618.DICRO.45.1.1  
618.DICRO.45.1M.1M  
618.DICRO.45.2.7  
618.DICRO.45.2.40  
618.DICRO.45.11.40  
618.DICRO.45.14.40

build-up  
60Va+105VA - use coolfit lamp  
Coolfit-Lampe verwenden

**618.ES50.45/.. - ZOOM CLICK + VOLTA**

~230V

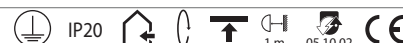

ceiling light - cone Ø65 H70  
Deckenleuchte - Kelch Ø65 H70

**Lamp type**

QPAR 51 GU10 (3) 50W 230V  
or QPAR 51 GU10 (3) 11W 230V

**Dimensions**

L480xB200xH115

L410xB130

**Ref**

618.ES50.45.1.1  
618.ES50.45.1M.1M  
618.ES50.45.2.7  
618.ES50.45.2.40  
618.ES50.45.11.40  
618.ES50.45.14.40

build-up

**618.ES63.45/.. - ZOOM CLICK + VOLTA**

~230V

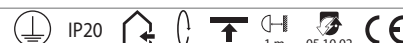

ceiling light - cone Ø78 H85  
Deckenleuchte - Kelch Ø78 H85

**Lamp type**

QPAR64 GU10 (3) 75W 230V

**Dimensions**

L480xB200xH130

L410xB130

**Ref**

618.ES63.45.1.1  
618.ES63.45.1M.1M  
618.ES63.45.2.7  
618.ES63.45.2.40  
618.ES63.45.11.40  
618.ES63.45.14.40

build-up

**619.AR70.45/.. - ZOOM CLICK + VOLTA**

~230V   IP20     0,5 m  



ceiling light - cone Ø78 H85 - with transformer  
Deckenleuchte - Kelch Ø78 H85 - mit Trafo

**Lamp type**  
QR-LP70 BA15d (4) 50W 12V

**Dimensions**  
L620xB200xH130  
L550xB130

**Ref**  
619.AR70.45.1.1  
619.AR70.45.1M.1M  
619.AR70.45.2.7  
619.AR70.45.2.40  
619.AR70.45.11.40  
619.AR70.45.14.40

build-up  
2x105VA

**619.DICRO.45/.. - ZOOM CLICK + VOLTA**

~230V   IP20     0,7194 0,5 m  



ceiling light - cone Ø65 H70 - with transformer  
Deckenleuchte - Kelch Ø65 H70 - mit Trafo

**Lamp type**  
QR-CB 51 coolfit GU5,3/GX5,3 (4) 35W 12V

**Dimensions**  
L620xB200xH115  
L550xB130

**Ref**  
619.DICRO.45.1.1  
619.DICRO.45.1M.1M  
619.DICRO.45.2.7  
619.DICRO.45.2.40  
619.DICRO.45.11.40  
619.DICRO.45.14.40

build-up  
2x105VA - use coolfit lamp  
Coolfit-Lampe verwenden

**619.ES50.45/.. - ZOOM CLICK + VOLTA**

~230V  IP20     1 m  



ceiling light - cone Ø65 H70  
Deckenleuchte - Kelch Ø65 H70

**Lamp type**  
QPAR 51 GU10 (4) 50W 230V  
or QPAR 51 GU10 (4) 11W 230V

**Dimensions**  
L620xB200xH115  
L550xB130

**Ref**  
619.ES50.45.1.1  
619.ES50.45.1M.1M  
619.ES50.45.2.7  
619.ES50.45.2.40  
619.ES50.45.11.40  
619.ES50.45.14.40

build-up

**619.ES63.45/.. - ZOOM CLICK + VOLTA**

~230V  IP20     1 m  



ceiling light - cone Ø78 H85  
Deckenleuchte - Kelch Ø78 H85

**Lamp type**  
QPAR64 GU10 (4) 75W 230V

**Dimensions**  
L620xB200xH130  
L550xB130

**Ref**  
619.ES63.45.1.1  
619.ES63.45.1M.1M  
619.ES63.45.2.7  
619.ES63.45.2.40  
619.ES63.45.11.40  
619.ES63.45.14.40

build-up

**620.AR70.45/.. - ZOOM CLICK + VOLTA**

~230V   IP20     0,5 m  05.10.02 



ceiling light - cone Ø78 H85 - with transformer  
Deckenleuchte - Kelch Ø78 H85 - mit Trafo

**Lamptype**

 QR-LP70 BA15d (4) 50W 12V

**Dimensions**

 L340xB340xH130

 L260xB260

**Ref**

- 620.AR70.45.1.1
- 620.AR70.45.1M.1M
- 620.AR70.45.2.7
- 620.AR70.45.2.40
- 620.AR70.45.11.40
- 620.AR70.45.14.40

build-up  
2x105VA

**620.DICRO.45/.. - ZOOM CLICK + VOLTA**

~230V   IP20     0,7322 0,5 m  05.10.02 



ceiling light - cone Ø65 H70 - with transformer  
Deckenleuchte - Kelch Ø65 H70 - mit Trafo

**Lamptype**

 QR-CB 51 coolfit GU5,3/GX5,3 (4) 35W 12V

**Dimensions**

 L340xB340xH115

 L260xB260

**Ref**

- 620.DICRO.45.1.1
- 620.DICRO.45.1M.1M
- 620.DICRO.45.2.7
- 620.DICRO.45.2.40
- 620.DICRO.45.11.40
- 620.DICRO.45.14.40

build-up  
2x105VA - use coolfit lamp  
Coolfit-Lampe verwenden

**620.ES50.45/.. - ZOOM CLICK + VOLTA**

~230V  IP20     1 m  05.10.02 



ceiling light - cone Ø65 H70  
Deckenleuchte - Kelch Ø65 H70

**Lamptype**

 QPAR 51 GU10 (4) 50W 230V  
or  QPAR 51 GU10 (4) 11W 230V

**Dimensions**

 L340xB340xH115

 L260xB260

**Ref**

- 620.ES50.45.1.1
- 620.ES50.45.1M.1M
- 620.ES50.45.2.7
- 620.ES50.45.2.40
- 620.ES50.45.11.40
- 620.ES50.45.14.40

build-up

**620.ES63.45/.. - ZOOM CLICK + VOLTA**

~230V  IP20     1 m  05.10.02 



ceiling light - cone Ø78 H85  
Deckenleuchte - Kelch Ø78 H85

**Lamptype**

 QPAR64 GU10 (4) 75W 230V

**Dimensions**

 L340xB340xH130

 L260xB260

**Ref**

- 620.ES63.45.1.1
- 620.ES63.45.1M.1M
- 620.ES63.45.2.7
- 620.ES63.45.2.40
- 620.ES63.45.11.40
- 620.ES63.45.14.40

build-up

978/.. - CUBIC

~230V   IP20     0,4450  0,5 m  05.10.02 



ceiling light - with transformer  
Deckenleuchte - mit Trafo

Ref  
978.14

**Lamptype**

◁ QR-CB 51 GU5,3/GX5,3 (1) 50W 12V

**Dimensions**

↔ L60xB60xH180

⌞ L60xB60xH67

build-up  
60VA

979/.. - CUBIC

~12V   IP20     0,2550  0,5 m  05.10.02 



ceiling light - without transformer  
Deckenleuchte - ohne Trafo

Ref  
979.14

**Lamptype**

◁ QR-CB 51 GU5,3/GX5,3 (1) 50W 12V

**Dimensions**

↔ L60xB60xH102

⌞ L60xB60xH25

build-up

979LED/.. - CUBIC

=700mA   IP20     0,5 m  05.10.02 



ceiling light LED included - without LED driver  
Deckenleuchte mit LED - ohne Driver LED

Ref  
979LED.14.CW  
979LED.14.WW

**Lamptype**

⚙ powered 700mA . (1) 3W 700mA

**Dimensions**

↔ L60xB60xH107  40° reflector

⌞ L60xB60xH25

build-up  
other °angle reflector on demand  
andere °Winkel Reflektor auf Anfrage

981/.. - CUBIC

~230V   IP20     0,5500  0,5 m  05.10.02 



ceiling light - with transformer  
Deckenleuchte - mit Trafo

Ref  
981.14

**Lamptype**

◁ QR-CB 51 GU5,3/GX5,3 (1) 50W 12V

**Dimensions**

↔ L115xB70xH125

⌞ L93xB50xH43

build-up  
60VA

981LED/.. - CUBIC

~230V   IP20    0,2925  0,5 m  05.10.02 



ceiling light LED included - with LED driver  
Deckenleuchte mit LED - mit Driver LED



Ref

981LED.14.CW  
981LED.14.WW

Lamp type

 powered 700mA . (1) 3W 700mA

Dimensions

 L115xB70xH125  40° reflector  
 L93xB50xH43

build-up  
other °angle reflector on demand  
andere °Winkel Reflektor auf Anfrage

982/.. - CUBIC

~230V   IP20    1,2000  0,5 m  05.10.02 



ceiling light - with transformer  
Deckenleuchte - mit Trafo



Ref

982.14

Lamp type

 QR-CB 51 GU5,3/GX5,3 (2) 50W 12V

Dimensions

 L200xB125xH125  
 L160xB95xH31

build-up  
105VA

982LED/.. - CUBIC

~230V   IP20    0,6635  0,5 m  05.10.02 



ceiling light LED included - with LED driver  
Deckenleuchte mit LED - mit Driver LED



Ref

982LED.14.CW  
982LED.14.WW

Lamp type

 powered 700mA . (2) 3W 700mA

Dimensions

 L200xB125xH125  40° reflector  
 L160xB95xH31

build-up  
other °angle reflector on demand  
andere °Winkel Reflektor auf Anfrage

983/.. - CUBIC

~230V   IP20    2,0000  0,5 m  05.10.02 

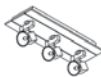

ceiling light - with transformer  
Deckenleuchte - mit Trafo

Ref

983.14

Lamp type

 QR-CB 51 GU5,3/GX5,3 (3) 50W 12V

Dimensions

 L340xB125xH125  
 L302xB95xH32

build-up  
60VA+105VA

983LED/.. - CUBIC

~230V   IP20    1,0850  0,5 m  05.10.02 



ceiling light LED included - with LED driver  
Deckenleuchte mit LED - mit Driver LED



Ref

983LED.14.CW  
983LED.14.WW

Lamp type

 powered 700mA . (3) 3W 700mA

Dimensions

 L340xB125xH125  40° reflector  
 L302xB95xH32

build-up  
other °angle reflector on demand  
andere °Winkel Reflektor auf Anfrage

984/.. - CUBIC

~230V   IP20    2,3600  0,5 m  05.10.02 



ceiling light - with transformer  
Deckenleuchte - mit Trafo



Ref

984.14

Lamp type

 QR-CB 51 GU5,3/GX5,3 (4) 50W 12V

Dimensions

 L215xB215xH125  
 L193xB170xH32

build-up  
2x105VA

984LED/.. - CUBIC

~230V   IP20    1,0965  0,5 m  05.10.02 



ceiling light LED included - with LED driver  
Deckenleuchte mit LED - mit Driver LED



Ref

984LED.14.CW  
984LED.14.WW

Lamp type

 powered 700mA . (4) 3W 700mA

Dimensions

 L215xB215xH125  40° reflector  
 L193xB170xH32

build-up  
other °angle reflector on demand  
andere °Winkel Reflektor auf Anfrage

911/.. - TITUS 230V

~230V  IP20    0,4642  1 m  05.10.02 



ceiling light  
Deckenleuchte



Ref

911.1M  
911.5  
911.7  
911.13  
911.14  
911.16

Lamp type

 QT14 G9 (1) 40W 230V  
or  CFL G9 (1) 7W 230V

Dimensions

 L125xB125xH90  
 L90xB90xH30

build-up

912/.. - TITUS 230V

~230V



ceiling light  
Deckenleuchte

**Lamptype**

☐ QT14 G9 (2) 40W 230V  
or ☐ CFL G9 (2) 7W 230V

**Dimensions**

↔ L300xB170xH85  
⌞ L225xB100xH25

**Ref**

912.1M  
912.5  
912.7  
912.13  
912.14  
912.16

build-up

913/.. - TITUS 230V

~230V



ceiling light  
Deckenleuchte

**Lamptype**

☐ QT14 G9 (3) 40W 230V  
or ☐ CFL G9 (3) 7W 230V

**Dimensions**

↔ L370xB170xH85  
⌞ L290xB100xH25

**Ref**

913.1M  
913.5  
913.7  
913.13  
913.14  
913.16

build-up

914/.. - TITUS 230V

~230V



ceiling light  
Deckenleuchte

**Lamptype**

☐ QT14 G9 (4) 40W 230V  
or ☐ CFL G9 (4) 7W 230V

**Dimensions**

↔ L300xB300xH85  
⌞ L220xB220xH25

**Ref**

914.1M  
914.5  
914.7  
914.13  
914.14  
914.16

build-up

1901/.. - TITUS SQ

~230V



ceiling light  
Deckenleuchte

**Lamptype**

☐ QT14 G9 (1) 40W 230V  
or ☐ CFL G9 (1) 7W 230V

**Dimensions**

↔ L130xB130xH90  
⌞ L110xB110xH30

**Ref**

1901.1M  
1901.7  
1901.13  
1901.14  
1901.16

build-up



1902/.. - TITUS SQ

~230V IP20 1,0870 1 m 05.10.02 CE



ceiling light  
Deckenleuchte

Lamptype

QT14 G9 (2) 40W 230V  
or CFL G9 (2) 7W 230V

Dimensions

L300xB170xH90  
L220xB100xH25

Ref

1902.1M  
1902.7  
1902.13  
1902.14  
1902.16

build-up

1903/.. - TITUS SQ

~230V IP20 1,5680 1 m 05.10.02 CE



ceiling light  
Deckenleuchte

Lamptype

QT14 G9 (3) 40W 230V  
or CFL G9 (3) 7W 230V

Dimensions

L390xB170xH90  
L310xB100xH25

Ref

1903.1M  
1903.7  
1903.13  
1903.14  
1903.16

build-up

1904/.. - TITUS SQ

~230V IP20 1,9690 1 m 05.10.02 CE



ceiling light  
Deckenleuchte

Lamptype

QT14 G9 (4) 40W 230V  
or CFL G9 (4) 7W 230V

Dimensions

L300xB300xH90  
L220xB220xH25

Ref

1904.1M  
1904.7  
1904.13  
1904.14  
1904.16

build-up

919/.. - BASE 4

~230V IP20 1,7120 0,5 m 05.10.02 CE



ceiling light - directional - with transformer  
Deckenleuchte - schwenkbar - mit Trafo

Lamptype

QR-CB 51 coolfit GU5,3/GX5,3 (4) 50W 12V

Dimensions

L150xB150xH132  
L140xB140

Ref

919.11  
919.14

build-up  
2x105VA - use coolfit lamp  
Coolfit-Lampe verwenden

972/.. - CALYPSO

~230V



ceiling light - directional - with transformer  
Deckenleuchte - schwenkbar - mit Trafo

Ref

972.14

Lamp type

QR-CB 51 coolfit GU5,3/GX5,3 (4) 50W 12V

Dimensions

L211xB211xH190

L140xB80xH40

build-up  
2x105VA - use coolfit lamp  
Coolfit-Lampe verwenden

973/.. - CALYPSO

~12V



ceiling light - directional - without transformer  
Deckenleuchte - schwenkbar - ohne Trafo

Ref

973.14

Lamp type

QR-CB 51 coolfit GU5,3/GX5,3 (4) 50W 12V

Dimensions

L211xB211xH155

L100xB100xH20

build-up  
use coolfit lamp  
Coolfit-Lampe verwenden

640.100/.. - MONET CARR...

~230V



ceiling light - stainless steel housing + polycarbonate cover  
Deckenleuchte - Gehäuse in Edelstahl + Deckel in Polykarbonat

Ref

640.100.1M

640.100.5

Lamp type

TC-FSE GX53 (1) 6W 230V

Dimensions

L105xB105xH60

Options

2320.230V/.. - TYPE A : LED CASSETTE 230V 3,6W IP65

2320.24V/.. - TYPE B : LED CASSETTE 24V-DC 3,6W IP65

build-up

640.200/.. - MONET CARR...

~230V



ceiling light - stainless steel housing + polycarbonate cover - with electronic gear  
Deckenleuchte - Gehäuse in Edelstahl + Deckel in Polykarbonat - mit elektronischem Vorschaltgerät

Ref

640.200.1M

640.200.5

Lamp type

TC-DD GR10q (1) 21W 230V

Dimensions

L205xB205xH60

build-up

640.300/.. - MONET CARR...

~230V



ceiling light - stainless steel housing + polycarbonate cover - with electronic gear  
Deckenleuchte - Gehäuse in Edelstahl + Deckel in Polykarbonat - mit elektronischem Vorschaltgerät

Ref

640.300.1M  
640.300.5

Lamp type

○ TL16-R 2GX13 (1) 22W 230V

Dimensions

↔ L305xB305xH60

build-up

640.400/.. - MONET CARR...

~230V



ceiling light - stainless steel housing + polycarbonate cover - with electronic gear  
Deckenleuchte - Gehäuse in Edelstahl + Deckel in Polykarbonat - mit elektronischem Vorschaltgerät

Ref

640.400.1M  
640.400.5

Lamp type

○ TL16-R 2GX13 (1) 55W 230V

Dimensions

↔ L405xB405xH60

build-up

641.SL335/.. - MONET STRIP

~230V



build-up ceiling or wall light - stainless steel housing + polycarbonate cover - with magnetic gear  
Decken- oder Wandleuchte für Aufbau - Gehäuse in Edelstahl + Deckel in Polykarbonat - mit magnetischem Vorschaltgerät

Ref

641.SL335.1M  
641.SL335.5

Lamp type

← TC-S G23 (1) 11W 230V

Dimensions

↔ L335xB55xH95

build-up

641.SL600/.. - MONET STRIP

~230V

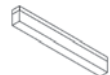

build-up ceiling or wall light - stainless steel housing + polycarbonate cover - with electronic gear  
Decken- oder Wandleuchte für Aufbau - Gehäuse in Edelstahl + Deckel in Polykarbonat - mit elektronischem Vorschaltgerät

Ref

641.SL600.1M  
641.SL600.5

Lamp type

⇒ T16FQT5 G5 (1) 24W 230V

Dimensions

↔ L605xB55xH95

build-up

3052/.. - MAMBO

~230V

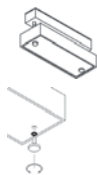

ceiling light  
Deckenleuchte

Ref

3052.2

Lamptype

— QT-DE 12 114,1mm R7s (1) 150W

230V

3052.11

3052.14

Dimensions

↔ L 220xB80xH105

⌈ L 220xB40xH50

*build-up*  
do not screw on too tightly  
nicht zu fest verschrauben

3053/.. - MAMBO

~230V

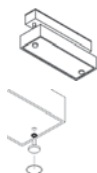

ceiling light - with magnetic gear  
Deckenleuchte - mit magnetischem Vorschaltgerät

Ref

3053.2

Lamptype

← TC-D G24D-3 (1) 26W

230V

3053.11

3053.14

Dimensions

↔ L 250xB80xH137

⌈ L 250xB50xH50

*build-up*  
do not screw on too tightly  
nicht zu fest verschrauben

646.1200/.. - STRIPE

~230V



build-up ceiling or wall light - with electronic gear  
Decken- oder Wandleuchte für Aufbau - mit elektronischem Vorschaltgerät

Ref

646.1200.1M

Lamptype

↔ T16-S HO T5 G5 (1) 54W

230V

646.1200.10

646.1200.14

Dimensions

↔ L 1200xB40xH70

⌈ L 1190xB36

*build-up*

646.600/.. - STRIPE

~230V



build-up ceiling or wall light - with electronic gear  
Decken- oder Wandleuchte für Aufbau - mit elektronischem Vorschaltgerät

Ref

646.600.1M

Lamptype

↔ T16-S HO T5 G5 (1) 24W

230V

646.600.10

646.600.14



Dimensions

↔ L 580xB40xH70

⌈ L 574xB36

*build-up*

646.900/.. - STRIPE

~230V  IP20    



build-up ceiling or wall light - with electronic gear  
Decken- oder Wandleuchte für Aufbau - mit elektronischem Vorschaltgerät

**Lamptype**

 T16-S HO T5 G5 (1) 39W 230V

**Dimensions**

 L900xB40xH70

 L890xB36

**Ref**

646.900.1M

646.900.10

646.900.14

build-up

927/.. - OVALE BOX - M10

~230V  IP20    



ceiling light - no room for transformer  
Deckenleuchte - kein Platz für Trafo

**Dimensions**

 L100xB55xH30

 L60xB33

**Ref**

927.1

927.1M

927.2

927.4

927.7

927.11

927.13

927.14

927.16

build-up  
230V - spot to be ordered separately  
Strahler separat zu bestellen

928/.. - OVALE BOX - M10

~230V  IP20    



ceiling light - no room for transformer  
Deckenleuchte - kein Platz für Trafo

**Dimensions**

 L240xB70xH30

 L160xB35

**Ref**

928.1

928.1M

928.2

928.4

928.7

928.11

928.13

928.14

928.16

build-up  
230V - spots to be ordered separately  
Strahler separat zu bestellen

929/.. - OVALE BOX - M10

~230V  IP20    



ceiling light - no room for transformer  
Deckenleuchte - kein Platz für Trafo

**Dimensions**

 L340xB70xH30

 L245xB35

**Ref**

929.1

929.1M

929.2

929.4

929.7

929.11

929.13

929.14

929.16

build-up  
230V - spots to be ordered separately  
Strahler separat zu bestellen

930/.. - OVALE BOX - M10

~230V



ceiling light - no room for transformer  
Deckenleuchte - kein Platz für Trafo

Dimensions

↔ L440xB70xH30

⚙ L335xB35

Ref

930.1  
930.1M  
930.2  
930.4  
930.7  
930.11  
930.13  
930.14  
930.16

build-up  
230V - spots to be ordered separately  
Strahler separat zu bestellen

923/.. - RONDO BOX - M10

~230V



ceiling light - spot to be ordered separately - with transformer  
Deckenleuchte - Strahler separat zu bestellen - mit Trafo

Dimensions

↔ Ø100xH52

⚙ Ø80

Ref

923.1  
923.1M  
923.2  
923.4  
923.7  
923.11  
923.13  
923.14  
923.16

build-up  
60VA

821/.. - RONDO BOX - M10

~230V



ceiling light - spots to be ordered separately - with transformer  
Deckenleuchte - Strahler separat zu bestellen - mit Trafo

Dimensions

↔ Ø150xH43

⚙ Ø125

Ref

821.1  
821.1M  
821.2  
821.4  
821.7  
821.11  
821.13  
821.14  
821.16

build-up  
105VA

822/.. - RONDO BOX - M10

~230V



ceiling light - spots to be ordered separately - with transformer  
Deckenleuchte - Strahler separat zu bestellen - mit Trafo

Dimensions

↔ Ø200xH43

⚙ Ø170

Ref

822.1  
822.1M  
822.2  
822.4  
822.7  
822.11  
822.13  
822.14  
822.16

build-up  
60VA+105VA

925C/.. - RONDO BOX - M10

~230V   IP20    0,4942 



ceiling light - spots to be ordered separately - with transformer  
Deckenleuchte - Strahler separat zu bestellen - mit Trafo

**Dimensions**

↔ Ø250xH43

⊕ Ø220

**Ref**

- 925C.1
- 925C.1M
- 925C.2
- 925C.4
- 925C.7
- 925C.11
- 925C.13
- 925C.14
- 925C.16

build-up  
60VA+105VA

925D/.. - RONDO BOX - M10

~230V   IP20    0,5401 

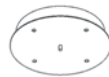

ceiling light - spots to be ordered separately - with transformer  
Deckenleuchte - Strahler separat zu bestellen - mit Trafo

**Dimensions**

↔ Ø250xH43

⊕ Ø220

**Ref**

- 925D.1
- 925D.1M
- 925D.2
- 925D.4
- 925D.7
- 925D.11
- 925D.13
- 925D.14
- 925D.16

build-up  
2x105VA

924A/.. - RONDO BOX - M10

~230V  IP20    0,1790 



ceiling light - spot to be ordered separately  
Deckenleuchte - Strahler separat zu bestellen

**Dimensions**

↔ Ø100xH25





⊕ Ø80

**Ref**

- 924A.1
- 924A.1M
- 924A.2
- 924A.4
- 924A.7
- 924A.11
- 924A.13
- 924A.14
- 924A.16

build-up

924B/.. - RONDO BOX - M10

~230V  IP20    0,0138 



ceiling light - spots to be ordered separately  
Deckenleuchte - Strahler separat zu bestellen

**Dimensions**

↔ Ø100xH25

⊕ Ø80

**Ref**

- 924B.1
- 924B.1M
- 924B.2
- 924B.4
- 924B.7
- 924B.11
- 924B.13
- 924B.14
- 924B.16

build-up

823/.. - RONDO BOX - M10

~230V



ceiling light - spots to be ordered separately  
Deckenleuchte - Strahler separat zu bestellen

**Dimensions**

↔ Ø150xH25

⊕ Ø125

**Ref**

823.1  
823.1M  
823.2  
823.4  
823.7  
823.11  
823.13  
823.14  
823.16

build-up

824/.. - RONDO BOX - M10

~230V



ceiling light - spots to be ordered separately  
Deckenleuchte - Strahler separat zu bestellen

**Dimensions**

↔ Ø200xH25

⊕ Ø175

**Ref**

824.1  
824.1M  
824.2  
824.4  
824.7  
824.11  
824.13  
824.14  
824.16

build-up

926C/.. - RONDO BOX - M10

~230V



ceiling light - spots to be ordered separately  
Deckenleuchte - Strahler separat zu bestellen

**Dimensions**

↔ Ø250xH26

⊕ Ø220

**Ref**

926C.1  
926C.1M  
926C.2  
926C.4  
926C.7  
926C.11  
926C.13  
926C.14  
926C.16

build-up

926D/.. - RONDO BOX - M10

~230V



ceiling light - spots to be ordered separately  
Deckenleuchte - Strahler separat zu bestellen

**Dimensions**

↔ Ø250xH26

⊕ Ø220

**Ref**

926D.1  
926D.1M  
926D.2  
926D.4  
926D.7  
926D.11  
926D.13  
926D.14  
926D.16

build-up



627.75/.. - RONDO CLICK I



ceiling light for build-in cassette Convertible System - without transformer  
Deckenleuchte für Einbaukassette Convertible System - ohne Trafo

**Dimensions**

→ Ø140xH75

↖ Ø100

**Ref**

627.75.1  
627.75.1M  
627.75.2  
627.75.11  
627.75.14

**build-up**  
all Convertible System cassettes to order separately  
alle Kassetten des Convertible Systems separat bestellen

628.75/.. - RONDO CLICK I



ceiling light for build-in cassette Convertible System - with transformer  
Deckenleuchte für Einbaukassette Convertible System - mit Trafo

**Dimensions**

→ Ø140xH75

↖ Ø100

**Options**

CASCANOC/.. - CONVERTIBLE SYSTEM  
CASPOLKA AR70 - DICRO  
CASSAXOC/.. - CONVERTIBLE SYSTEM  
CASTURNERC/.. - CONVERTIBLE SYSTEM  
CASZENO.B3.C/.. - CONVERTIBLE SYSTEM  
CASZENOC/.. - CONVERTIBLE SYSTEM

**Ref**

628.75.1  
628.75.1M  
628.75.2  
628.75.11  
628.75.14

**build-up**  
60VA

629.35/.. - RONDO CLICK II



ceiling light for build-in cassette Convertible System - without transformer  
Deckenleuchte für Einbaukassette Convertible System - ohne Trafo

**Dimensions**

→ Ø240xH35

↖ Ø175

**Options**

CASCANOC/.. - CONVERTIBLE SYSTEM  
CASPOLKA AR70 - DICRO - ES50 - ES63  
CASSAXOC/.. - CONVERTIBLE SYSTEM  
CASTURNERC/.. - CONVERTIBLE SYSTEM  
CASZENO.B3.C/.. - CONVERTIBLE SYSTEM  
CASZENOC/.. - CONVERTIBLE SYSTEM

**Ref**

629.35.1  
629.35.1M  
629.35.2  
629.35.11  
629.35.14

**build-up**

630.47/.. - RONDO CLICK II



ceiling light for build-in cassette Convertible System - with transformer  
Deckenleuchte für Einbaukassette Convertible System - mit Trafo

**Dimensions**

→ Ø240xH35

↖ Ø175

**Options**

CASCANOC/.. - CONVERTIBLE SYSTEM  
CASPOLKA AR70 - DICRO  
CASSAXOC/.. - CONVERTIBLE SYSTEM  
CASTURNERC/.. - CONVERTIBLE SYSTEM  
CASZENO.B3.C/.. - CONVERTIBLE SYSTEM  
CASZENOC/.. - CONVERTIBLE SYSTEM

**Ref**

630.47.1  
630.47.1M  
630.47.2  
630.47.11  
630.47.14

**build-up**  
105VA

631.35/.. - RONDO CLICK III



ceiling light for build-in cassette Convertible System - without transformer  
Deckenleuchte für Einbaukassette Convertible System - ohne Trafo

**Dimensions**

→ Ø320xH35

↖ Ø215

**Options**

- CASCANOC/.. - CONVERTIBLE SYSTEM
- CASPOLKA AR70 - DICRO - ES50 - ES63
- CASSAXOC/.. - CONVERTIBLE SYSTEM
- CASTURNERC/.. - CONVERTIBLE SYSTEM
- CASZENO.B3.C/.. - CONVERTIBLE SYSTEM
- CASZENOC/.. - CONVERTIBLE SYSTEM

**Ref**

- 631.35.1
- 631.35.1M
- 631.35.2
- 631.35.11
- 631.35.14

build-up

632.47/.. - RONDO CLICK III



ceiling light for build-in cassette Convertible System - with transformer  
Deckenleuchte für Einbaukassette Convertible System - mit Trafo

**Dimensions**

→ Ø320xH47

↖ Ø215

**Options**

- CASCANOC/.. - CONVERTIBLE SYSTEM
- CASPOLKA AR70 - DICRO
- CASSAXOC/.. - CONVERTIBLE SYSTEM
- CASTURNERC/.. - CONVERTIBLE SYSTEM
- CASZENO.B3.C/.. - CONVERTIBLE SYSTEM
- CASZENOC/.. - CONVERTIBLE SYSTEM

**Ref**

- 632.47.1
- 632.47.1M
- 632.47.2
- 632.47.11
- 632.47.14

build-up  
60VA+105VA

633.35/.. - RONDO CLICK IV



ceiling light for build-in cassette Convertible System - without transformer  
Deckenleuchte für Einbaukassette Convertible System - ohne Trafo

**Dimensions**

→ Ø320xH35

↖ Ø245

**Options**

- CASCANOC/.. - CONVERTIBLE SYSTEM
- CASPOLKA AR70 - DICRO - ES50 - ES63
- CASSAXOC/.. - CONVERTIBLE SYSTEM
- CASTURNERC/.. - CONVERTIBLE SYSTEM
- CASZENO.B3.C/.. - CONVERTIBLE SYSTEM
- CASZENOC/.. - CONVERTIBLE SYSTEM

**Ref**

- 633.35.1
- 633.35.1M
- 633.35.2
- 633.35.11
- 633.35.14

build-up

634.47/.. - RONDO CLICK IV



ceiling light for build-in cassette Convertible System - with transformer  
Deckenleuchte für Einbaukassette Convertible System - mit Trafo

**Dimensions**

→ Ø320xH47

↖ Ø245

**Options**

- CASCANOC/.. - CONVERTIBLE SYSTEM
- CASPOLKA AR70 - DICRO
- CASSAXOC/.. - CONVERTIBLE SYSTEM
- CASTURNERC/.. - CONVERTIBLE SYSTEM
- CASZENO.B3.C/.. - CONVERTIBLE SYSTEM
- CASZENOC/.. - CONVERTIBLE SYSTEM

**Ref**

- 634.47.1
- 634.47.1M
- 634.47.2
- 634.47.11
- 634.47.14

build-up  
2x105VA

621.AR70/.. - CUPIDO I

~12V



ceiling light - cone Ø78 H85 - without transformer  
Deckenleuchte - Kelch Ø78 H85 - ohne Trafo

**Lamptype**  
QR-LP70 BA15d (1) 50W 12V

**Dimensions**  
Ø140xH130  
Ø100

**Ref**  
621.AR70.1.1  
621.AR70.1M  
621.AR70.2.7  
621.AR70.2.40  
621.AR70.11.40  
621.AR70.14.40

build-up

621.DICRO/.. - CUPIDO I

~12V



ceiling light - cone Ø65 H70 - without transformer  
Deckenleuchte - Kelch Ø65 H70 - ohne Trafo

**Lamptype**  
QR-CB 51 coolfit GU5,3/GX5,3 (1) 35W 12V

**Dimensions**  
Ø140xH115  
Ø100

**Ref**  
621.DICRO.1.1  
621.DICRO.1M  
621.DICRO.2.7  
621.DICRO.2.40  
621.DICRO.11.40  
621.DICRO.14.40

build-up  
use coolfit lamp  
Coolfit-Lampe verwenden

621.ES50/.. - CUPIDO I

~230V IP20



ceiling light - cone Ø65 H70  
Deckenleuchte - Kelch Ø65 H70

**Lamptype**  
QPAR 51 GU10 (1) 50W 230V  
or QPAR 51 GU10 (1) 11W 230V

**Dimensions**  
Ø140xH115  
Ø100

**Ref**  
621.ES50.1.1  
621.ES50.1M  
621.ES50.2.7  
621.ES50.2.40  
621.ES50.11.40  
621.ES50.14.40

build-up

621.ES63/.. - CUPIDO I

~230V IP20



ceiling light - cone Ø78 H85  
Deckenleuchte - Kelch Ø78 H85

**Lamptype**  
QPAR64 GU10 (1) 75W 230V

**Dimensions**  
Ø140xH130  
Ø100

**Ref**  
621.ES63.1.1  
621.ES63.1M  
621.ES63.2.7  
621.ES63.2.40  
621.ES63.11.40  
621.ES63.14.40

build-up

625.AR70/.. - CUPIDO I

~230V   IP20     0,5 m  05.10.02 



ceiling light - cone Ø78 H85 - with transformer  
Deckenleuchte - Kelch Ø78 H85 - mit Trafo

**Lamptype**

 QR-LP70 BA15d (1) 50W 12V

**Dimensions**

 Ø140xH160

 Ø100

**Ref**

625.AR70.1.1  
625.AR70.1M  
625.AR70.2.7  
625.AR70.2.40  
625.AR70.11.40  
625.AR70.14.40

build-up  
60VA

625.DICRO/.. - CUPIDO I

~230V   IP20     0,5 m  05.10.02 



ceiling light - cone Ø65 H70 - with transformer  
Deckenleuchte - Kelch Ø65 H70 - mit Trafo

**Lamptype**

 QR-CB 51 coolfit GU5,3/GX5,3 (1) 35W 12V

**Dimensions**

 Ø140xH145

 Ø100

**Ref**

625.DICRO.1.1  
625.DICRO.1M  
625.DICRO.2.7  
625.DICRO.2.40  
625.DICRO.11.40  
625.DICRO.14.40

build-up  
60VA - use coolfit lamp  
Coolfit-Lampe verwenden

622.AR70/.. - CUPIDO II

~230V   IP20     0,5 m  05.10.02 



ceiling light - cone Ø78 H85 - with transformer  
Deckenleuchte - Kelch Ø78 H85 - mit Trafo

**Lamptype**

 QR-LP70 BA15d (2) 50W 12V

**Dimensions**

 Ø240xH120

 Ø175

**Ref**

622.AR70.1.1  
622.AR70.1M  
622.AR70.2.7  
622.AR70.2.40  
622.AR70.11.40  
622.AR70.14.40

build-up  
105VA

622.DICRO/.. - CUPIDO II

~230V   IP20     0,5 m  05.10.02 



ceiling light - cone Ø65 H70 - with transformer  
Deckenleuchte - Kelch Ø65 H70 - mit Trafo

**Lamptype**

 QR-CB 51 coolfit GU5,3/GX5,3 (2) 35W 12V

**Dimensions**

 Ø240xH105

 Ø175

**Ref**

622.DICRO.1.1  
622.DICRO.1M  
622.DICRO.2.7  
622.DICRO.2.40  
622.DICRO.11.40  
622.DICRO.14.40

build-up  
105VA - use coolfit lamp  
Coolfit-Lampe verwenden



622.ES50/.. - CUPIDO II

~230V  IP20    0.3170  1 m  05.10.02 





ceiling light - cone Ø65 H70  
Deckenleuchte - Kelch Ø65 H70

**Lamptype**

 QPAR 51 GU10 (2) 50W 230V  
or  QPAR 51 GU10 (2) 11W 230V

**Dimensions**

 Ø240xH105  
 Ø175

**Ref**

622.ES50.1.1  
622.ES50.1M  
622.ES50.2.7  
622.ES50.2.40  
622.ES50.11.40  
622.ES50.14.40

build-up

622.ES63/.. - CUPIDO II

~230V  IP20    1 m  05.10.02 





ceiling light - cone Ø78 H85  
Deckenleuchte - Kelch Ø78 H85

**Lamptype**

 QPAR64 GU10 (2) 75W 230V

**Dimensions**

 Ø240xH120  
 Ø175

**Ref**

622.ES63.1.1  
622.ES63.1M  
622.ES63.2.7  
622.ES63.2.40  
622.ES63.11.40  
622.ES63.14.40

build-up

623.AR70/.. - CUPIDO III

~230V  IP20    0.5 m  05.10.02 





ceiling light - cone Ø78 H85 - with transformer  
Deckenleuchte - Kelch Ø78 H85 - mit Trafo

**Lamptype**

 QR-LP70 BA15d (3) 50W 12V

**Dimensions**

 Ø320xH132  
 Ø215

**Ref**

623.AR70.1.1  
623.AR70.1M  
623.AR70.2.7  
623.AR70.2.40  
623.AR70.11.40  
623.AR70.14.40

build-up  
60VA+105VA

623.DICRO/.. - CUPIDO III

~230V  IP20    0.5 m  05.10.02 





ceiling light - cone Ø65 H70 - with transformer  
Deckenleuchte - Kelch Ø65 H70 - mit Trafo

**Lamptype**

 QR-CB 51 coolfit GU5,3/GX5,3 (3) 35W 12V

**Dimensions**

 Ø320xH117  
 Ø215

**Ref**

623.DICRO.1.1  
623.DICRO.1M  
623.DICRO.2.7  
623.DICRO.2.40  
623.DICRO.11.40  
623.DICRO.14.40

build-up  
60VA+105VA - use coolfit lamp  
Coolfit-Lampe verwenden

623.ES50/.. - CUPIDO III

~230V  IP20    0,9233  1 m  05.10.02 



ceiling light - cone Ø65 H70  
Deckenleuchte - Kelch Ø65 H70

**Lamptype**

 QPAR 51 GU10 (3) 50W 230V  
or  QPAR 51 GU10 (3) 11W 230V

**Dimensions**

 Ø320xH105  
 Ø215

**Ref**

623.ES50.1.1  
623.ES50.1M  
623.ES50.2.7  
623.ES50.2.40  
623.ES50.11.40  
623.ES50.14.40

build-up

623.ES63/.. - CUPIDO III

~230V  IP20    1 m  05.10.02 



ceiling light - cone Ø78 H85  
Deckenleuchte - Kelch Ø78 H85

**Lamptype**

 QPAR64 GU10 (3) 75W 230V

**Dimensions**

 Ø320xH120  
 Ø215

**Ref**

623.ES63.1.1  
623.ES63.1M  
623.ES63.2.7  
623.ES63.2.40  
623.ES63.11.40  
623.ES63.14.40

build-up

624.AR70/.. - CUPIDO IV

~230V  IP20    0,5 m  05.10.02 



ceiling light - cone Ø78 H85 - with transformer  
Deckenleuchte - Kelch Ø78 H85 - mit Trafo

**Lamptype**

 QR-LP70 BA15d (4) 50W 12V

**Dimensions**

 Ø320xH132  
 Ø245

**Ref**

624.AR70.1.1  
624.AR70.1M  
624.AR70.2.7  
624.AR70.2.40  
624.AR70.11.40  
624.AR70.14.40

build-up  
2x105VA

624.DICRO/.. - CUPIDO IV

~230V  IP20    0,5 m  05.10.02 



ceiling light - cone Ø65 H70 - with transformer  
Deckenleuchte - Kelch Ø65 H70 - mit Trafo

**Lamptype**

 QR-CB 51 coolfit GU5,3/GX5,3 (4) 35W 12V

**Dimensions**

 Ø320xH117  
 Ø245

**Ref**

624.DICRO.1.1  
624.DICRO.1M  
624.DICRO.2.7  
624.DICRO.2.40  
624.DICRO.11.40  
624.DICRO.14.40

build-up  
2x105VA - use coolfit lamp  
Coolfit-Lampe verwenden

624.ES50/.. - CUPIDO IV

~230V  IP20   1,0613  1 m  05.10.02 





ceiling light - cone Ø65 H70  
Deckenleuchte - Kelch Ø65 H70

**Lamptype**

 QPAR 51 GU10 (4) 50W 230V  
or  QPAR 51 GU10 (4) 11W 230V

**Dimensions**

 Ø320xH105  
 Ø245

**Ref**

624.ES50.1.1  
624.ES50.1M  
624.ES50.2.7  
624.ES50.2.40  
624.ES50.11.40  
624.ES50.14.40

build-up

624.ES63/.. - CUPIDO IV

~230V  IP20   1 m  05.10.02 





ceiling light - cone Ø78 H85  
Deckenleuchte - Kelch Ø78 H85

**Lamptype**

 QPAR64 GU10 (4) 75W 230V

**Dimensions**

 Ø320xH120  
 Ø245

**Ref**

624.ES63.1.1  
624.ES63.1M  
624.ES63.2.7  
624.ES63.2.40  
624.ES63.11.40  
624.ES63.14.40

build-up

995/.. - TITUS Round

~230V  IP20   0,5804  1 m  05.10.02 





ceiling light  
Deckenleuchte

**Lamptype**

 QT14 G9 (1) 40W 230V  
or  CFL G9 (1) 7W 230V

**Dimensions**

 Ø140xH90  
 Ø100

**Ref**

995.1M  
995.7  
995.13  
995.14  
995.16

build-up

996/.. - TITUS Round

~230V  IP20   0,9942  1 m  05.10.02 





ceiling light  
Deckenleuchte

**Lamptype**

 QT14 G9 (2) 40W 230V  
or  CFL G9 (2) 7W 230V

**Dimensions**

 Ø200xH90  
 Ø160

**Ref**

996.1M  
996.7  
996.13  
996.14  
996.16

build-up

997/.. - TITUS Round

~230V



ceiling light  
Deckenleuchte

Lamp type

☐ QT14 G9 (3) 40W 230V  
or ☐ CFL G9 (3) 7W 230V

Dimensions

↔ Ø245xH90  
⚙️ Ø190

Ref

997.1M  
997.7  
997.13  
997.14  
997.16

build-up

998/.. - TITUS Round

~230V



ceiling light  
Deckenleuchte

Lamp type

☐ QT14 G9 (4) 40W 230V  
or ☐ CFL G9 (4) 7W 230V

Dimensions

↔ Ø300xH90  
⚙️ Ø220

Ref

998.1M  
998.7  
998.13  
998.14  
998.16

build-up

642.250/.. - MONET ROND

~230V



ceiling light - polycarbonate - with electronic gear  
Deckenleuchte - Polykarbonat - mit elektronischem  
Vorschaltgerät

Lamp type

○ TL16-R 2GX13 (1) 22W 230V

Dimensions

↔ Ø254xH65  
⚙️ Ø254

Ref

642.250.1M  
642.250.7  
642.250.14

build-up

colour bronze 13 - mat gold 16 - red copper 30 on  
request  
Farbe bronze 13 - mattes Gold 16 - rotes Kupfer 30 auf  
Anfrage

642.350/.. - MONET ROND

~230V



ceiling light - polycarbonate - with electronic gear  
Deckenleuchte - Polykarbonat - mit elektronischem  
Vorschaltgerät

Lamp type

○ TL16-R 2GX13 (1) 55W 230V

Dimensions

↔ Ø340xH65  
⚙️ Ø340

Ref

642.350.1M  
642.350.7  
642.350.14

build-up

colour bronze 13 - mat gold 16 - red copper 30 on  
request  
Farbe bronze 13 - mattes Gold 16 - rotes Kupfer 30 auf  
Anfrage



1287/.. - PLAZA

~230V   IP20     0,5300  0,5 m  05.10.02 



ceiling light - directional - with transformer  
Deckenleuchte - schwenkbar - mit Trafo

Ref  
1287.14

**Lamptype**

 QR-CB 51 coolfit GU5,3/GX5,3 (1) 50W 12V

**Dimensions**

 Ø60xH200

 Ø56

build-up  
60VA - use coolfit lamp  
Coolfit-Lampe verwenden

986/.. - STAR

~12V   IP20     2,9300  0,5 m  05.10.02 



ceiling light - directional - without transformer  
Deckenleuchte - schwenkbar - ohne Trafo

Ref  
986.14

**Lamptype**

 QR-CB 51 GU5,3/GX5,3 (1) 50W 12V

**Dimensions**

 Ø56xH146

 Ø56xH32

build-up

987/.. - STAR

~230V   IP20     0,4250  0,5 m  05.10.02 



ceiling light - directional - with transformer  
Deckenleuchte - schwenkbar - mit Trafo

Ref  
987.14

**Lamptype**

 QR-CB 51 GU5,3/GX5,3 (1) 50W 12V

**Dimensions**

 Ø56xH176

 Ø56xH60

build-up  
60VA

985.A.12V/.. - RINGO

~12V   IP20     0,3500  1 m  05.10.02 



ceiling light - directional - without transformer  
Deckenleuchte - schwenkbar - ohne Trafo

Ref  
985.A.12V.10

**Lamptype**

 QR-CB 51 GU5,3/GX5,3 (1) 50W 12V

**Dimensions**

 Ø60xH130

 Ø56

build-up

985.A.230V/.. - RINGO

~230V  IP20    0,3800  1 m  05.10.02 



ceiling light - directional  
Deckenleuchte - schwenkbar

Ref

985.A.230V.10

Lamptype

 QPAR 51 GU10 (1) 50W 230V

Dimensions

 Ø60xH130

 Ø56

build-up

985.B.12V/.. - RINGO

~12V   IP20    0,3500  1 m  05.10.02 



ceiling light - directional - without transformer  
Deckenleuchte - schwenkbar - ohne Trafo

Ref

985.B.12V.10

Lamptype

 QR-CB 51 GU5,3/GX5,3 (1) 50W 12V

Dimensions

 Ø60xH130

 Ø56

build-up

985.B.230V/.. - RINGO

~230V  IP20    0,3800  1 m  05.10.02 



ceiling light - directional  
Deckenleuchte - schwenkbar

Ref

985.B.230V.10

Lamptype

 QPAR 51 GU10 (1) 50W 230V

Dimensions

 Ø60xH130

 Ø56

build-up

985.C.12V/.. - RINGO

~12V   IP20    0,3500  1 m  05.10.02 



ceiling light - directional - without transformer  
Deckenleuchte - schwenkbar - ohne Trafo

Ref

985.C.12V.10

Lamptype

 QR-CB 51 GU5,3/GX5,3 (1) 50W 12V

Dimensions

 Ø60xH130

 Ø56

build-up

985.C.230V/.. - RINGO

~230V IP20 0,3800 1 m 05.10.02



ceiling light - directional  
Deckenleuchte - schwenkbar

Ref

985.C.230V.10

Lamptype

QPAR 51 GU10 (1) 50W 230V

Dimensions

Ø60xH130

Ø56

build-up

1293/.. - SIRIO

~230V IP20 0,7450 1 m 05.10.02



build-up ceiling or wall light - directional  
Decken- oder Wandleuchte für Aufbau - schwenkbar

Ref

1293.14

Lamptype

QT14 G9 (1) 40W 230V

or CFL G9 (1) 7W 230V

Dimensions

Ø140xH170 40° reflector

Ø100xH30

build-up  
other °angle reflector on demand  
andere °Winkel Reflektor auf Anfrage



# INDOOR | Architectural

## BETA SYSTEM

FRAME1F/./.. P.218



CASBETA/./.. P.223



## BETAPLUS

1701.E550/.. P.226



1706.E550/.. P.229



1713.TCDE/..P.232



## SPINNER X

### FORUM

1882/./DICRO P.234



1887/./DICRO P.238



### AR70

1879/.. P.241



1877/.. P.242



### QR111

1851/.. P.243



## SPINNER X

### CDMR-111

1855/.. P.245



1865/.. P.247



### CDM-T

1857/.. P.246



1866/.. P.248



### QR111

1863/.. P.247



## SPINNER

950/.. P.248



952/.. P.248



## QUADRO

970/.. P.251



1254/.. P.251



1253/.. P.252



## CAMERA

945/./S1 P.255



947/.. P.257



## RETRO

1450/.. P.257



1451/.. P.258



## BRIDGE

1800/.. P.258



## INCA

1475/.. P.258



## INCA X

1477/.. P.259



## QUORUM

1480/.. P.260



## SNOWBOX

1520.13W/.. P.253



1522.13W/.. P.254



## TORPEDO

1490LED/.. P.263



1495LED/.. P.266



1499/.. P.268



## TWIPE

1801/.. P.276



1802/.. P.277



## LOBBY

1412/.. P.275



## LOBBY

1415/.. P.276



## GOTA

1820/.. P.278



## BAMBU

1470/.. P.292



## AMBON

1454/.. P.293.



**OPERA**



**OLIVIA**



**OLIVIA MINI**



**FLASH**

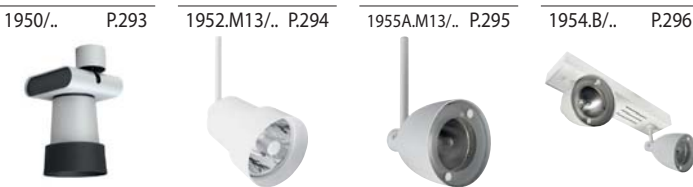

ADAPTOR - M10 - M13	296, 297
ADAPTOR - M13	297
AMBON	293
BAMBU	292, 293
BETAPLUS	226, 227, 228, 229, 230, 231, 232
BETA SYSTEM	218, 219, 220, 221, 222, 223, 224, 225, 226
BETA SYSTEM - M10	224
BRIDGE	258
CAMERA IN CAMERA TWIN	255, 256, 257
FLASH	293, 294
GOTA	278
INCA - INCA X	258, 259
LOBBY	275, 276
OLIVIA	279, 280, 281, 282, 283, 284, 287
OLIVIA MINI	287, 288, 289, 290, 291, 292
OLIVIA PENDEL B1 - B3 - E27 - ES111	285, 286
OLIVIA PLAASTERKIT	281
OPERA	268, 269, 270, 271, 272, 274, 275
OPERA 4 IN LINE	273
OPERA 6 IN LINE	273, 274
QUADRO	251, 252, 253
QUORUM	260, 261
RETRO	257, 258
SNOWBOX	253, 254
SPINNER - SPINNER CDMT	248, 249, 250, 251
SPINNER ETALAGE	251
SPINNER X	243, 244, 245, 246, 247, 248
SPINNER X AR70	239, 240, 241, 242, 243
SPINNER X FORUM	233, 234, 235, 236, 237, 238, 239
TORPEDO	263, 264, 265, 266, 267, 268
TWIPE	276, 277
VOLTA 12V - M10	294
ZUMBA	295, 296

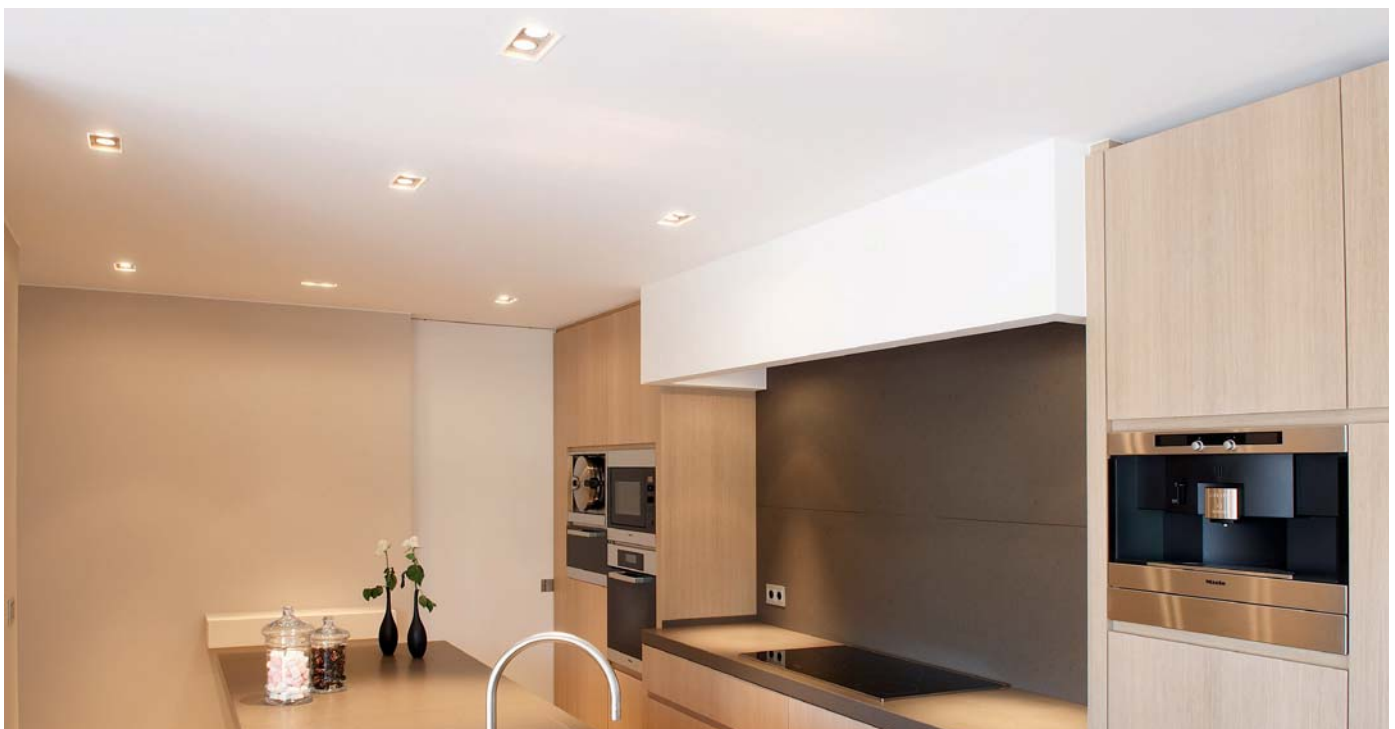

**BETA SYSTEM**

**BASES | S1** springveren - ressorts à torsion - torsion springs - Torsionfeder

**| S2** bladveren - ressorts à lamelles - flat springs - Blattfeder



frame1f S1



frame2f S1



frame3f S1



frame1f S2



frame2f S2



frame3f S2

**CASSETTES**



casbeta DICRO - ES50 - MEGA



casalfa DICRO - ES50 - MEGA



casfino 12V/230V

spot of pendel afzonderlijk te bestellen  
spot ou suspension à commander séparément  
spot or pendant to order separately  
Spot oder Pendelleuchte separat bestellen



casecho DICRO - ES50 - MEGA



casecho2 DICRO - ES50 - MEGA



casecho3 TC-DEL

**FRAME1F/./S1 - 75x75 BETA SYSTEM**

S1 IP20 0,0850



build-in base for cassette - square  
Einbaubasis für Kassette - viereckig

**Dimensions**

↔ L84,5xB84,5xH80

75x75

**Options**

- CASSETTE BETASYSTEM
- MATRIX1F/.. - BETA SYSTEM
- S.1F/.. - BETA SYSTEM

**Ref**

- FRAME1F.1M.S1
- FRAME1F.2M.S1
- FRAME1F.7.S1
- FRAME1F.11.S1
- FRAME1F.11M.S1

build-in

**FRAME1F/./S2 - 75x75 BETA SYSTEM**

S2 IP20 0,0568



build-in base for cassette - square  
Einbaubasis für Kassette - viereckig

**Dimensions**

↔ L84,5xB84,5xH80

75x75

**Options**

- BOX1F/.. - BETA SYSTEM
- CASSETTE BETASYSTEM
- MATRIX1F/.. - BETA SYSTEM
- MATRIXBOX1F/.. - BETA SYSTEM
- S.1F/.. - BETA SYSTEM

**Ref**

- FRAME1F.1M.S2
- FRAME1F.2M.S2
- FRAME1F.7.S2
- FRAME1F.11.S2
- FRAME1F.11M.S2

build-in

**BOX1F/.. - BETA SYSTEM**

IP20   



accessories - mould for 1 module  
Zubehör - Gießform für 1 Modul

Ref

BOX1F

**Dimensions**

↔ L80xB80xH137

build-in

**MATRIXBOX1F/.. - BETA SYSTEM**

IP20   



accessories - matrix for mould 1F  
Zubehör - Matrice für Gießform 1F

Ref

MATRIXBOX1F

**Dimensions**

↔ L220xB220

**MATRIX1F/.. - BETA SYSTEM**

IP20   

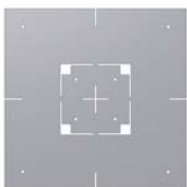

accessories - matrix for gyproc 1  
Zubehör - Matrice für Gyproc 1

Ref

MATRIX1F

**Dimensions**

↔ L200xB200

**S.1F/.. - BETA SYSTEM**

IP20   

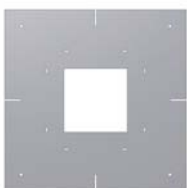

plasterkit  
Einputzrahmen

Ref

S.1F

**Dimensions**

↔ L220xB220

**FRAME2F../S1 - 75x147 BETA SYSTEM**

S1 IP20    



build-in base for 2 cassettes - square  
Einbaubasis für 2 Kassetten - viereckig

**Dimensions**

↔ L84,5xB156xH80

 75x147

**Options**

CASSETTES BETA SYSTEM  
MATRIX2F../ - BETA SYSTEM  
S.2F../ - BETA SYSTEM

**Ref**

FRAME2F.1M.S1  
FRAME2F.2M.S1  
FRAME2F.7.S1  
FRAME2F.11.S1  
FRAME2F.11M.S1

build-in

**FRAME2F../S2 - 75x147 BETA SYSTEM**

S2 IP20   



build-in base for 2 cassettes - square  
Einbaubasis für 2 Kassetten - viereckig

**Dimensions**

↔ L84,5xB156xH80

 75x147

**Options**

BOX2F../ - BETA SYSTEM  
CASSETTES BETA SYSTEM  
MATRIX2F../ - BETA SYSTEM  
MATRIXBOX2F../ - BETA SYSTEM  
S.2F../ - BETA SYSTEM

**Ref**

FRAME2F.1M.S2  
FRAME2F.2M.S2  
FRAME2F.7.S2  
FRAME2F.11.S2  
FRAME2F.11M.S2

build-in

**BOX2F../ - BETA SYSTEM**

IP20   

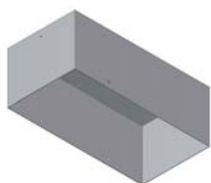

accessories - mould for 2 modules  
Zubehör - Gießform für 2 Moduln

**Dimensions**

↔ L150xB80xH137

**Ref**

BOX2F

build-in

**MATRIXBOX2F../ - BETA SYSTEM**

IP20   



accessories - matrix for mould 2F  
Zubehör - Matrice für Gießform 2F

**Dimensions**

↔ L290xB220

**Ref**

MATRIXBOX2F



**MATRIX2F/.. - BETA SYSTEM**

IP20   

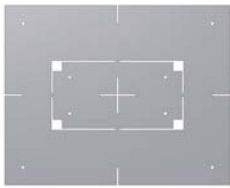

accessories - matrix for gyproc 2  
Zubehör - Matrizze für Gyproc 2

**Dimensions**

↔ L250xB200

**Ref**

MATRIX2F

**S.2F/.. - BETA SYSTEM**

IP20   



plasterkit  
Einputzrahmen

**Dimensions**

↔ L290xB220

**Ref**

S.2F

**FRAME3F/..S1 - 75x218 BETA SYSTEM**

S1 IP20    0,0550 



build-in base for 3 cassettes - square  
Einbaubasis für 3 Kassetten - viereckig

**Dimensions**

↔ L84,5xB226xH80

 75x218

**Options**

CASSETTES BETA SYSTEM  
MATRIX3F/.. - BETA SYSTEM  
S.3F/.. - BETA SYSTEM

**Ref**

FRAME3F.1M.S1  
FRAME3F.2M.S1  
FRAME3F.7.S1  
FRAME3F.11.S1  
FRAME3F.11M.S1

build-in

**FRAME3F/..S2 - 75x218 BETA SYSTEM**

S2 IP20   



build-in base for 3 cassettes - square  
Einbaubasis für 3 Kassetten - viereckig

**Dimensions**

↔ L84,5xB226xH80

 75x218

**Options**

BOX3F/.. - BETA SYSTEM  
CASSETTES BETA SYSTEM  
MATRIX3F/.. - BETA SYSTEM  
MATRIXBOX3F/.. - BETA SYSTEM  
S.3F/.. - BETA SYSTEM

**Ref**

FRAME3F.1M.S2  
FRAME3F.2M.S2  
FRAME3F.7.S2  
FRAME3F.11.S2  
FRAME3F.11M.S2

build-in

**BOX3F/.. - BETA SYSTEM**

IP20   

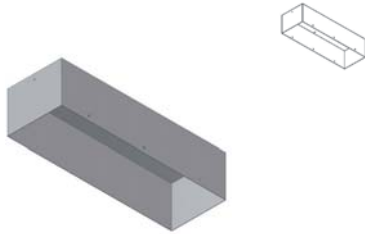

accessories - mould for 3 modules  
Zubehör - Gießform für 3 Moduln

Ref  
BOX3F

**Dimensions**  
↔ L220xB80xH137

build-in

**MATRIXBOX3F/.. - BETA SYSTEM**

IP20   

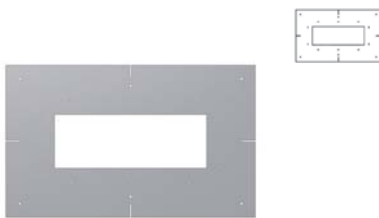

accessories - matrix for mould 3F  
Zubehör - Matrice für Gießform 3F

Ref  
MATRIXBOX3F

**Dimensions**  
↔ L360xB220

**MATRIX3F/.. - BETA SYSTEM**

IP20   



accessories - matrix for gyproc 3  
Zubehör - Matrice für Gyproc 3

Ref  
MATRIX3F

**Dimensions**  
↔ L320xB200

**S.3F/.. - BETA SYSTEM**

IP20   



plasterkit  
Einputzrahmen

Ref  
S.3F

**Dimensions**  
↔ L360xB220

**CASALFA.DICRO/.. - BETA SYSTEM**

~12V



build-in cassette - fixed - without transformer  
Einbaukassette - fest - ohne Trafo

**Lamp type**  
QR-CB 51 GU5,3/GX5,3 (1) 50W 12V

**Dimensions**  
L71xB71xH80  
100

**Ref**  
CASALFA.DICRO.1M  
CASALFA.DICRO.2M  
CASALFA.DICRO.7  
CASALFA.DICRO.11M  
CASALFA.DICRO.14

build-in

**CASALFA.ES50/.. - BETA SYSTEM**

~230V



build-in cassette - fixed  
Einbaukassette - fest

**Lamp type**  
QPAR 51 GU10 (1) 50W 230V

**Dimensions**  
L71xB71xH90  
110

**Ref**  
CASALFA.ES50.1M  
CASALFA.ES50.2M  
CASALFA.ES50.7  
CASALFA.ES50.11M  
CASALFA.ES50.14

build-in

**CASALFA.MEGA/.. - BETA SYSTEM**

~230V



build-in cassette - fixed  
Einbaukassette - fest

**Lamp type**  
QPAR 51 GU10 (1) 11W 230V

**Dimensions**  
L71xB71xH90  
110

**Ref**  
CASALFA.MEGA.1M  
CASALFA.MEGA.2M  
CASALFA.MEGA.5  
CASALFA.MEGA.7  
CASALFA.MEGA.11M

build-in

**CASBETA.DICRO/.. - BETA SYSTEM**

~12V



build-in cassette - directional - without transformer  
Einbaukassette - schwenkbar - ohne Trafo

**Lamp type**  
QR-CB 51 GU5,3/GX5,3 (1) 50W 12V

**Dimensions**  
L71xB71xH80  
100

**Ref**  
CASBETA.DICRO.1M  
CASBETA.DICRO.2M  
CASBETA.DICRO.7  
CASBETA.DICRO.11M  
CASBETA.DICRO.14

build-in

**CASBETA.ES50/.. - BETA SYSTEM**

~230V



build-in cassette - directional  
Einbaukassette - schwenkbar

**Lamptype**

QPAR 51 GU10 (1) 50W

230V

**Dimensions**

L71xB71xH90

110

**Ref**

- CASBETA.ES50.1M
- CASBETA.ES50.2M
- CASBETA.ES50.7
- CASBETA.ES50.11M
- CASBETA.ES50.14

build-in

**CASFINO.12V/.. - BETA SYSTEM - M10**

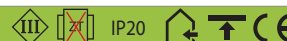

build-in cassette for spotlight or pendant - spot to be ordered separately - without transformer  
Einbaukassette für Aufbaustrahler oder Pendelleuchte - Strahler separat zu bestellen - ohne Trafo

**Dimensions**

L71xB71xH65

65

**Ref**

- CASFINO.12V.1M
- CASFINO.12V.2M
- CASFINO.12V.7
- CASFINO.12V.11M
- CASFINO.12V.14

build-in  
12V

**CASFINO.230V/.. - BETA SYSTEM - M10**

~230V



build-in cassette for spotlight or pendant - spot to be ordered separately  
Einbaukassette für Aufbaustrahler oder Pendelleuchte - Strahler separat zu bestellen

**Dimensions**

L71xB71xH65

65

**Ref**

- CASFINO.230V.1M
- CASFINO.230V.2M
- CASFINO.230V.7
- CASFINO.230V.11M
- CASFINO.230V.14

build-in  
230V

**CASECHO.DICRO/.. - BETA SYSTEM**

~12V



build-in cassette - fixed - with glass - without transformer  
Einbaukassette - fest - mit Glas - ohne Trafo

**Lamptype**

QR-CB 51 GU5,3/GX5,3 (1) 50W

12V

**Dimensions**

L71xB71xH90

110

**Ref**

- CASECHO.DICRO.1M
- CASECHO.DICRO.2M
- CASECHO.DICRO.5
- CASECHO.DICRO.7
- CASECHO.DICRO.11M

build-in

CASECHO.E550/.. - BETA SYSTEM

~230V  IP20    1 m  05.10.02 



build-in cassette - fixed - with glass  
Einbaukassette - fest - mit Glas

**Lamptype**

 QPAR 51 GU10 (1) 35W 230V

**Dimensions**

 L71xB71xH90

 110

**Ref**

- CASECHO.E550.1M
- CASECHO.E550.2M
- CASECHO.E550.5
- CASECHO.E550.7
- CASECHO.E550.11M

build-in

CASECHO.MEGA/.. - BETA SYSTEM

~230V  IP20    1 m  05.10.02 



build-in cassette - fixed - with glass  
Einbaukassette - fest - mit Glas

**Lamptype**

 QPAR 51 GU10 (1) 11W 230V

**Dimensions**

 L71xB71xH90

 110

**Ref**

- CASECHO.MEGA.1M
- CASECHO.MEGA.2M
- CASECHO.MEGA.5
- CASECHO.MEGA.7
- CASECHO.MEGA.11M

build-in

CASECHO.2.DICRO/.. - BETA SYSTEM

~12V   IP20    0,5 m  05.10.02 



build-in cassette - fixed - with glass - without transformer  
Einbaukassette - fest - mit Glas - ohne Trafo

**Lamptype**

 QR-CB 51 GU5,3/GX5,3 (2) 35W 12V

**Dimensions**

 L143xB71xH90

 110

**Ref**

- CASECHO.2.DICRO.1M
- CASECHO.2.DICRO.2M
- CASECHO.2.DICRO.5
- CASECHO.2.DICRO.7
- CASECHO.2.DICRO.11M

build-in

CASECHO.2.E550/.. - BETA SYSTEM

~230V  IP20    0,5 m  05.10.02 



build-in cassette - fixed - with glass  
Einbaukassette - fest - mit Glas

**Lamptype**

 QPAR 51 GU10 (2) 35W 230V

**Dimensions**

 L143xB71xH90

 110

**Ref**

- CASECHO.2.E550.1M
- CASECHO.2.E550.2M
- CASECHO.2.E550.5
- CASECHO.2.E550.7
- CASECHO.2.E550.11M

build-in

**CASECHO.2.MEGA/.. - BETA SYSTEM**

~230V  IP20   0,5m  05.10.02 





build-in cassette - fixed - with glass  
Einbaukassette - fest - mit Glas

**Lamptype**

 QPAR 51 GU10 (2) 11W 230V

**Dimensions**



 L143xB71xH90  
 110

**Ref**

- CASECHO.2.MEGA.1M
- CASECHO.2.MEGA.2M
- CASECHO.2.MEGA.5
- CASECHO.2.MEGA.7
- CASECHO.2.MEGA.11M

build-in

**CASECHO.3.TCDE/.. - BETA SYSTEM**

~230V  IP20   1 m  05.10.50 





build-in cassette - fixed - with glass - with electronic gear  
Einbaukassette - fest - mit Glas - mit elektronischem  
Vorschaltgerät

**Lamptype**

 TC-DEL G24Q2 (1) 18W 230V

**Dimensions**

 L213xB71xH90  
 110

**Ref**

- CASECHO.3.TCDE.5

build-in

**1701.DICRO/.. - BETAPLUS**

~12V   IP20   0,3330  0,5 m  05.10.02 



ceiling light - fixed - without transformer  
Deckenleuchte - fest - ohne Trafo

**Lamptype**

 QR-CB 51 coolfit GU5,3/GX5,3 (1) 50W 12V

**Dimensions**

 L90xB90xH110

**Ref**

- 1701.DICRO.1M
- 1701.DICRO.2M
- 1701.DICRO.7
- 1701.DICRO.11M
- 1701.DICRO.14.11

build-up  
use coolfit lamp  
Coolfit-Lampe verwenden

**1701.ES50/.. - BETAPLUS**

~230V  IP20   0,3460  1 m  05.10.02 



ceiling light - fixed  
Deckenleuchte - fest

**Lamptype**

 QPAR 51 GU10 (1) 50W 230V

**Dimensions**

 L90xB90xH110

**Ref**

- 1701.ES50.1M
- 1701.ES50.2M
- 1701.ES50.7
- 1701.ES50.11M
- 1701.ES50.14.11.5

build-up

1701.ES63/.. - BETAPLUS

~230V IP20 0,1750 1 m 05.10.02



ceiling light - fixed  
Deckenleuchte - fest

Lamptype

QPAR64 GU10 (1) 75W 230V

Dimensions

L90xB90xH110

Ref

- 1701.ES63.1M
- 1701.ES63.2M
- 1701.ES63.7
- 1701.ES63.11M
- 1701.ES63.14.11.5

build-up

1701.MEGA/.. - BETAPLUS

~230V IP20 0,1750 1 m 05.10.02



ceiling light - fixed  
Deckenleuchte - fest

Lamptype

QPAR 51 GU10 (1) 11W 230V

Dimensions

L90xB90xH110

Ref

- 1701.MEGA.1M
- 1701.MEGA.2M
- 1701.MEGA.7
- 1701.MEGA.11M
- 1701.MEGA.14.11.5

build-up

1702.DICRO/.. - BETAPLUS

~12V III IP20 0,2370 0,5 m 05.10.02



ceiling light - fixed - without transformer  
Deckenleuchte - fest - ohne Trafo

Lamptype

QR-CB 51 coolfit GU5,3/GX5,3 (2) 50W 12V

Dimensions

L162xB90xH110

Ref

- 1702.DICRO.1M
- 1702.DICRO.2M
- 1702.DICRO.7
- 1702.DICRO.11M
- 1702.DICRO.14.11

build-up  
use coolfit lamp  
Coolfit-Lampe verwenden

1702.ES50/.. - BETAPLUS

~230V IP20 0,2420 1 m 05.10.02



ceiling light - fixed  
Deckenleuchte - fest

Lamptype

QPAR 51 GU10 (2) 35W 230V

Dimensions

L162xB90xH110

Ref

- 1702.ES50.1M
- 1702.ES50.2M
- 1702.ES50.7
- 1702.ES50.11M
- 1702.ES50.14.11.5

build-up

1702.MEGA/.. - BETAPLUS

~230V  IP20    1 m  05.10.02 



ceiling light - fixed  
Deckenleuchte - fest

**Lamptype**

 QPAR 51 GU10 (2) 11W 230V

**Dimensions**

 L162xB90xH110

**Ref**

1702.MEGA.1M  
1702.MEGA.2M  
1702.MEGA.7  
1702.MEGA.11M  
1702.MEGA.14.11.5

build-up

1703.DICRO/.. - BETAPLUS

~12V   IP20    0,5 m  05.10.02 



ceiling light - fixed - without transformer  
Deckenleuchte - fest - ohne Trafo

**Lamptype**

 QR-CB 51 coolfit GU5,3/GX5,3 (3) 50W 12V

**Dimensions**

 L232xB90xH110

**Ref**

1703.DICRO.1M  
1703.DICRO.2M  
1703.DICRO.7  
1703.DICRO.11M  
1703.DICRO.14.11.5

build-up  
use coolfit lamp  
Coolfit-Lampe verwenden

1703.ES50/.. - BETAPLUS

~230V  IP20    1 m  05.10.02 



ceiling light - fixed  
Deckenleuchte - fest

**Lamptype**

 QPAR 51 GU10 (3) 35W 230V

**Dimensions**

 L232xB90xH110

**Ref**

1703.ES50.1M  
1703.ES50.2M  
1703.ES50.7  
1703.ES50.11M  
1703.ES50.14.11.5

build-up

1703.MEGA/.. - BETAPLUS

~230V  IP20    1 m  05.10.02 



ceiling light - fixed  
Deckenleuchte - fest

**Lamptype**

 QPAR 51 GU10 (3) 11W 230V

**Dimensions**

 L232xB90xH110

**Ref**

1703.MEGA.1M  
1703.MEGA.2M  
1703.MEGA.7  
1703.MEGA.11M  
1703.MEGA.14.11.5

build-up



1705.DICRO/.. - BETAPLUS

~12V 0,5130 0,5 m 05.10.02



ceiling light - directional - without transformer  
Deckenleuchte - schwenkbar - ohne Trafo

**Lamptype**

QR-CB 51 coolfit GU5,3/GX5,3 (1) 50W 12V

**Dimensions**

L90xB90xH110

**Ref**

- 1705.DICRO.1M
- 1705.DICRO.2M
- 1705.DICRO.7
- 1705.DICRO.11M
- 1705.DICRO.14.11

*build-up*  
use coolfit lamp  
Coolfit-Lampe verwenden

1705.ES50/.. - BETAPLUS

~230V IP20 0,5220 1 m 05.10.02



ceiling light - directional  
Deckenleuchte - schwenkbar

**Lamptype**

QPAR 51 GU10 (1) 35W 230V

**Dimensions**

L90xB90xH110

**Ref**

- 1705.ES50.1M
- 1705.ES50.2M
- 1705.ES50.7
- 1705.ES50.11M
- 1705.ES50.14.11

*build-up*

1706.DICRO/.. - BETAPLUS

~12V 0,7360 0,5 m 05.10.02



ceiling light - directional - without transformer  
Deckenleuchte - schwenkbar - ohne Trafo

**Lamptype**

QR-CB 51 coolfit GU5,3/GX5,3 (2) 50W 12V

**Dimensions**

L162xB90xH110

**Ref**

- 1706.DICRO.1M
- 1706.DICRO.2M
- 1706.DICRO.7
- 1706.DICRO.11M
- 1706.DICRO.14.11

*build-up*  
use coolfit lamp  
Coolfit-Lampe verwenden

1706.ES50/.. - BETAPLUS

~230V IP20 0,5060 1 m 05.10.02



ceiling light - directional  
Deckenleuchte - schwenkbar

**Lamptype**

QPAR 51 GU10 (2) 35W 230V

**Dimensions**

L162xB90xH110

**Ref**

- 1706.ES50.1M
- 1706.ES50.2M
- 1706.ES50.7
- 1706.ES50.11M
- 1706.ES50.14.11

*build-up*

1707.DICRO/.. - BETAPLUS

~12V



ceiling light - directional - without transformer  
Deckenleuchte - schwenkbar - ohne Trafo

**Lamptype**

QR-CB 51 coolfit GU5,3/GX5,3 (3) 50W 12V

**Dimensions**

↔ L232xB90xH110

**Ref**

- 1707.DICRO.1M
- 1707.DICRO.2M
- 1707.DICRO.7
- 1707.DICRO.11M
- 1707.DICRO.14.11

*build-up*  
use coolfit lamp  
Coolfit-Lampe verwenden

1707.ES50/.. - BETAPLUS

~230V



ceiling light - directional  
Deckenleuchte - schwenkbar

**Lamptype**

QPAR 51 GU10 (3) 35W 230V

**Dimensions**

↔ L232xB90xH110

**Ref**

- 1707.ES50.1M
- 1707.ES50.2M
- 1707.ES50.7
- 1707.ES50.11M
- 1707.ES50.14.11

*build-up*

1711.DICRO/.. - BETAPLUS

~12V



ceiling light - with glass - without transformer  
Deckenleuchte - mit Glas - ohne Trafo

**Lamptype**

QR-CB 51 coolfit GU5,3/GX5,3 (1) 35W 12V

**Dimensions**

↔ L90xB90xH110

**Ref**

- 1711.DICRO.1M
- 1711.DICRO.2M
- 1711.DICRO.7
- 1711.DICRO.11M
- 1711.DICRO.14.11.5

*build-up*  
use coolfit lamp  
Coolfit-Lampe verwenden

1711.ES50/.. - BETAPLUS

~230V



ceiling light - with glass  
Deckenleuchte - mit Glas

**Lamptype**

QPAR 51 GU10 (1) 35W 230V

**Dimensions**

↔ L90xB90xH110

**Ref**

- 1711.ES50.1M
- 1711.ES50.2M
- 1711.ES50.7
- 1711.ES50.11M
- 1711.ES50.14.11.5

*build-up*

1711.MEGA/.. - BETAPLUS

~230V IP20 1 m 05.10.02



ceiling light - with glass  
Deckenleuchte - mit Glas

Lamptype

QPAR 51 GU10 (1) 11W 230V

Dimensions

L90xB90xH110

Ref

- 1711.MEGA.1M
- 1711.MEGA.2M
- 1711.MEGA.7
- 1711.MEGA.11M
- 1711.MEGA.14.11.5

build-up

1712.DICRO/.. - BETAPLUS

~12V IP20 0,5 m 05.10.02



ceiling light - with glass - without transformer  
Deckenleuchte - mit Glas - ohne Trafo

Lamptype

QR-CB 51 coolfit GU5,3/GX5,3 (2) 35W 12V

Dimensions

L162xB90xH110

Ref

- 1712.DICRO.1M
- 1712.DICRO.2M
- 1712.DICRO.7
- 1712.DICRO.11M
- 1712.DICRO.14.11.5

build-up  
use coolfit lamp  
Coolfit-Lampe verwenden

1712.ES50/.. - BETAPLUS

~230V IP20 1 m 05.10.02



ceiling light - with glass  
Deckenleuchte - mit Glas

Lamptype

QPAR 51 GU10 (2) 35W 230V

Dimensions

L162xB90xH110

Ref

- 1712.ES50.1M
- 1712.ES50.2M
- 1712.ES50.7
- 1712.ES50.11M
- 1712.ES50.14.11.5

build-up

1712.MEGA/.. - BETAPLUS

~230V IP20 1 m 05.10.02



ceiling light - with glass  
Deckenleuchte - mit Glas

Lamptype

QPAR 51 GU10 (2) 11W 230V

Dimensions

L162xB90xH110

Ref

- 1712.MEGA.1M
- 1712.MEGA.2M
- 1712.MEGA.7
- 1712.MEGA.11M
- 1712.MEGA.14.11.5

build-up

1713.DICRO/.. - BETAPLUS

~12V IP20



ceiling light - with glass - without transformer  
Deckenleuchte - mit Glas - ohne Trafo

**Lamptype**

QR-CB 51 coolfit GU5,3/GX5,3 (3) 35W 12V

**Dimensions**

L232xB90xH110

**Ref**

- 1713.DICRO.1M
- 1713.DICRO.2M
- 1713.DICRO.7
- 1713.DICRO.11M
- 1713.DICRO.14.11.5

*build-up*  
use coolfit lamp  
Coolfit-Lampe verwenden

1713.ES50/.. - BETAPLUS

~230V IP20



ceiling light - with glass  
Deckenleuchte - mit Glas

**Lamptype**

QPAR 51 GU10 (3) 35W 230V

**Dimensions**

L232xB90xH110

**Ref**

- 1713.ES50.1M
- 1713.ES50.2M
- 1713.ES50.7
- 1713.ES50.11M
- 1713.ES50.14.11.5

*build-up*

1713.MEGA/.. - BETAPLUS

~230V IP20



ceiling light - with glass  
Deckenleuchte - mit Glas

**Lamptype**

QPAR 51 GU10 (3) 11W 230V

**Dimensions**

L232xB90xH110

**Ref**

- 1713.MEGA.1M
- 1713.MEGA.2M
- 1713.MEGA.7
- 1713.MEGA.11M
- 1713.MEGA.14.11.5

*build-up*

1713.TCDE/.. - BETAPLUS

~230V IP20



ceiling light - with glass - with electronic gear  
Deckenleuchte - mit Glas - mit elektronischem Vorschaltgerät

**Lamptype**

TC-DEL G24Q2 (1) 18W 230V

**Dimensions**

L232xB90xH110

**Ref**

- 1713.TCDE.1M
- 1713.TCDE.2M
- 1713.TCDE.7
- 1713.TCDE.11M
- 1713.TCDE.14.11.5

*build-up*

1881.././DICRO - SPINNER X FORUM

~12V 05.10.02



build-in ceiling light - without transformer  
Einbau Deckenleuchte - ohne Trafo

Ref

- 1881.1M.DICRO
- 1881.2.DICRO
- 1881.11.DICRO

Lamp type

QR-CB 51 GU5,3/GX5,3 (1) 50W 12V

Dimensions

L102xB102xH100

93X93 125

Options

1881.././A - SPINNER X FORUM plasterkit

build-in

1881.././ES50 - SPINNER X FORUM

~230V IP20 05.10.02



build-in ceiling light  
Einbau Deckenleuchte

Ref

- 1881.1M.ES50
- 1881.2.ES50
- 1881.11.ES50

Lamp type

QPAR 51 GU10 (1) 50W 230V  
or QPAR 51 GU10 (1) 11W 230V

Dimensions

L102xB102xH122

93X93 147

Options

1850../. - SPINNER X DOWNRING  
1881.././A - SPINNER X FORUM plasterkit

build-in

1850../. - SPINNER X DOWNRING

IP20

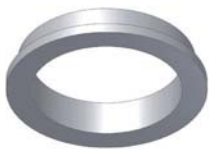

supplement  
Supplement

Ref

build-in

1881.././A - SPINNER X FORUM plasterkit

IP20

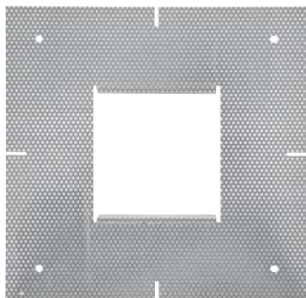

plasterkit 1 module  
Einputzrahmen 1 Modul

Ref

1881.A

Dimensions

L225xB225

94x94

build-in

1882/..//DICRO - SPINNER X FORUM

~12V IP20 0.3300 1 m 05.10.02



build-in ceiling light - without transformer  
Einbau Deckenleuchte - ohne Trafo

Ref

1882.1M.DICRO  
1882.2.DICRO  
1882.11.DICRO

Lamp type

QR-CB 51 GU5,3/GX5,3 (2) 50W 12V

Dimensions

L196xB102xH100

185x93 125

Options

1882/..//A - SPINNER X FORUM plasterkit

build-in

1882/..//ES50 - SPINNER X FORUM

~230V IP20 1 m 05.10.02



build-in ceiling light  
Einbau Deckenleuchte

Ref

1882.1M.ES50  
1882.2.ES50  
1882.11.ES50

Lamp type

QPAR 51 GU10 (2) 50W 230V  
or QPAR 51 GU10 (2) 11W 230V

Dimensions

L196xB102xH122

185x93 147

Options

1850/.. - SPINNER X DOWNRING

1882/..//A - SPINNER X FORUM plasterkit

build-in

1882/..//A - SPINNER X FORUM plasterkit

IP20

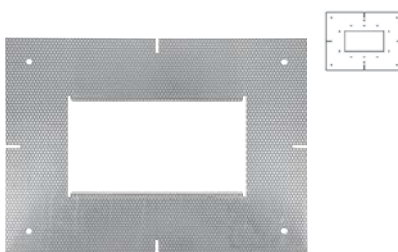

plasterkit 2 modules  
Einputzrahmen 2 Modul

Ref

1882.A

Dimensions

L320xB225

186x94

build-in

1883/..//DICRO - SPINNER X FORUM

~12V IP20 1 m 05.10.02



build-in ceiling light - without transformer  
Einbau Deckenleuchte - ohne Trafo

Ref

1883.1M.DICRO  
1883.2.DICRO  
1883.11.DICRO

Lamp type

QR-CB 51 GU5,3/GX5,3 (3) 50W 12V

Dimensions

L278xB102xH100

269x93 125

Options

1883/..//A - SPINNER X FORUM plasterkit

build-in

1883/.. /ES50 - SPINNER X FORUM

~230V IP20



build-in ceiling light  
Einbau Deckenleuchte

Ref

1883.1M.ES50

Lamptype

QPAR 51 GU10 (3) 50W 230V

1883.2.ES50

or QPAR 51 GU10 (3) 11W 230V

1883.11.ES50

Dimensions

L278xB102xH122

269x93 147

Options

1850/.. - SPINNER X DOWNRING

1883/.. /A - SPINNER X FORUM plasterkit

build-in

1883/.. /A - SPINNER X FORUM plasterkit

IP20

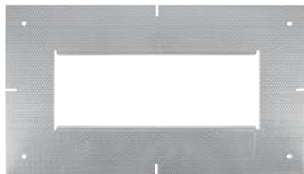

plasterkit 3 modules  
Einputzrahmen 3 Moduln

Ref

1883.A

Dimensions

L400xB225

269x94

build-in

1884/.. /DICRO - SPINNER X FORUM

~12V IP20



build-in ceiling light - without transformer  
Einbau Deckenleuchte - ohne Trafo

Ref

1884.1M.DICRO

Lamptype

QR-CB 51 GU5,3/GX5,3 (4) 50W 12V

1884.2.DICRO

Dimensions

L362xB102xH100

353x93 125

1884.11.DICRO

Options

1884/.. /A - SPINNER X FORUM plasterkit

build-in

1884/.. /ES50 - SPINNER X FORUM

~230V IP20



build-in ceiling light  
Einbau Deckenleuchte

Ref

1884.1M.ES50

Lamptype

QPAR 51 GU10 (4) 50W 230V

1884.2.ES50

or QPAR 51 GU10 (4) 11W 230V

1884.11.ES50

Dimensions

L362xB102xH122

353x93 147

Options

1850/.. - SPINNER X DOWNRING

1884/.. /A - SPINNER X FORUM plasterkit

build-in

1884/..../A - SPINNER X FORUM plasterkit

IP20   

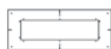

plasterkit 4 modules  
Einputzrahmen 4 Moduln

Ref  
1884.A

**Dimensions**

 L485xB225

 353x94

build-in

1889/..../DICRO - SPINNER X FORUM

~12V   IP20    



build-in ceiling light - without transformer  
Einbau Deckenleuchte - ohne Trafo

Ref  
1889.1M.DICRO  
1889.2.DICRO  
1889.11.DICRO

**Lamptype**

 QR-CB 51 GU5,3/GX5,3 (4) 50W 12V

**Dimensions**

 L202xB202xH100

 193x193  125

**Options**

1889/..../A - SPINNER X FORUM plasterkit

build-in

1889/..../ES50 - SPINNER X FORUM

~230V  IP20    



build-in ceiling light  
Einbau Deckenleuchte

Ref  
1889.1M.ES50  
1889.2.ES50  
1889.11.ES50

**Lamptype**

 QPAR 51 GU10 (4) 50W 230V

or  QPAR 51 GU10 (4) 11W 230V

**Dimensions**

 L202xB202xH122

 193x193  147

**Options**

1850/..../ - SPINNER X DOWNRING

1889/..../A - SPINNER X FORUM plasterkit

build-in

1889/..../A - SPINNER X FORUM plasterkit

IP20   

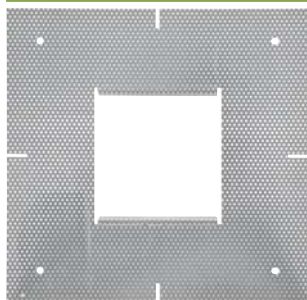

plasterkit  
Einputzrahmen

Ref  
1889.A

**Dimensions**

 L300xB300

 194x194

build-in



1885/.. /DICRO - SPINNER X FORUM

~230V   IP20      



build-up ceiling light - with transformer  
Aufbau Deckenleuchte - mit Trafo

**Lamptype**

 QR-CB 51 coolfit GU5,3/GX5,3 (1) 50W 12V

**Dimensions**

↔ L100xB100xH130

**Ref**

1885.1M.DICRO  
1885.11M.2.DICRO

build-up  
60VA - use coolfit lamp  
Coolfit-Lampe verwenden

1885/.. /ES50 - SPINNER X FORUM

~230V  IP20      



build-up ceiling light  
Aufbau Deckenleuchte

**Lamptype**

 QPAR 51 GU10 (1) 35W 230V  
or  QPAR 51 GU10 (1) 11W 230V

**Dimensions**

↔ L100xB100xH130

**Options**

1850/.. - SPINNER X DOWNRING

**Ref**

1885.1M.ES50  
1885.11M.2.ES50

build-up

1886/.. /DICRO - SPINNER X FORUM

~230V   IP20      



build-up ceiling light - with transformer  
Aufbau Deckenleuchte - mit Trafo

**Lamptype**

 QR-CB 51 coolfit GU5,3/GX5,3 (2) 50W 12V

**Dimensions**

↔ L182xB100xH130

**Ref**

1886.1M.DICRO  
1886.11M.2.DICRO

build-up  
105VA - use coolfit lamp  
Coolfit-Lampe verwenden

1886/.. /ES50 - SPINNER X FORUM

~230V  IP20      



build-up ceiling light  
Aufbau Deckenleuchte

**Lamptype**

 QPAR 51 GU10 (2) 35W 230V  
or  QPAR 51 GU10 (2) 11W 230V

**Dimensions**

↔ L182xB100xH130

**Options**

1850/.. - SPINNER X DOWNRING

**Ref**

1886.1M.ES50  
1886.11M.2.ES50

build-up

1887/././DICRO - SPINNER X FORUM

~230V



build-up ceiling light - with transformer  
Aufbau Deckenleuchte - mit Trafo

**Lamptype**

QR-CB 51 coolfit GU5,3/GX5,3 (3) 50W 12V

**Dimensions**

↔ L266xB100xH130

**Ref**

1887.1M.DICRO  
1887.11M.2.DICRO

*build-up*  
2x105VA - use coolfit lamp  
Coolfit-Lampe verwenden

1887/././ES50 - SPINNER X FORUM

~230V



build-up ceiling light  
Aufbau Deckenleuchte

**Lamptype**

QPAR 51 GU10 (3) 35W 230V  
or QPAR 51 GU10 (3) 11W 230V

**Dimensions**

↔ L266xB100xH130

**Options**

1850/.. - SPINNER X DOWNRING

**Ref**

1887.1M.ES50  
1887.11M.2.ES50

*build-up*

1888/././DICRO - SPINNER X FORUM

~230V



build-up ceiling light - with transformer  
Aufbau Deckenleuchte - mit Trafo

**Lamptype**

QR-CB 51 coolfit GU5,3/GX5,3 (4) 50W 12V

**Dimensions**

↔ L350xB100xH130

**Ref**

1888.1M.DICRO  
1888.11M.2.DICRO

*build-up*  
2x105VA - use coolfit lamp  
Coolfit-Lampe verwenden

1888/././ES50 - SPINNER X FORUM

~230V



build-up ceiling light  
Aufbau Deckenleuchte

**Lamptype**

QPAR 51 GU10 (4) 35W 230V  
or QPAR 51 GU10 (4) 11W 230V

**Dimensions**

↔ L350xB100xH130

**Options**

1850/.. - SPINNER X DOWNRING

**Ref**

1888.1M.ES50  
1888.11M.2.ES50

*build-up*

1890/..//DICRO - SPINNER X FORUM

~230V   IP20    



build-up ceiling light - with transformer  
Aufbau Deckenleuchte - mit Trafo

Ref

1890.1M.DICRO  
1890.11M.2.DICRO

Lamptype

 QR-CB 51 coolfit GU5,3/GX5,3 (4) 50W 12V

Dimensions

 L198xB198xH130

build-up  
2x105VA - use coolfit lamp  
Coolfit-Lampe verwenden

1890/..//ES50 - SPINNER X FORUM

~230V  IP20    



build-up ceiling light  
Aufbau Deckenleuchte

Ref

1890.1M.ES50  
1890.11M.2.ES50

Lamptype

 QPAR 51 GU10 (4) 35W 230V  
or  QPAR 51 GU10 (4) 11W 230V

Dimensions

 L198xB198xH130

Options

1850/.. - SPINNER X DOWNRING

build-up

1871/.. - SPINNER X AR70

~12V   IP20      



build-in ceiling light - without transformer  
Einbau Deckenleuchte - ohne Trafo



Ref

1871.1M.1M  
1871.2.14  
1871.11.14

Lamptype

 QR-LP70 BA15d (1) 50W 12V

Dimensions

 L127xB127xH92  
 118x118  117

Options

1871/..//A - SPINNER X AR70 plasterkit

build-in

1871/..//A - SPINNER X AR70 plasterkit

IP20   

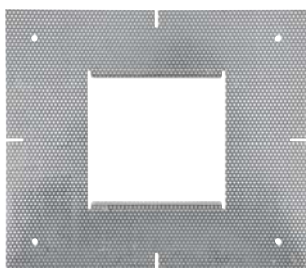



plasterkit 1 module  
Einputzrahmen 1 Modul

Ref

1871.A

Dimensions

 L260xB225  
 118x118

build-in

1872/.. - SPINNER X AR70

~12V IP20 0,4100 1 m 05.10.02



build-in ceiling light - without transformer  
Einbau Deckenleuchte - ohne Trafo

Ref

1872.1M.1M

Lamptype

1872.2.14

QR-LP70 BA15d (2) 50W 12V

1872.11.14

Dimensions

L230xB127xH92

222x118 117

Options

1872/./A - SPINNER X AR70 plasterkit

build-in

1872/./A - SPINNER X AR70 plasterkit

IP20

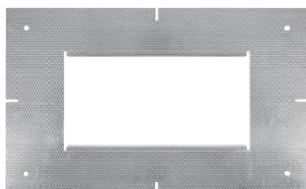

plasterkit 2 modules  
Einputzrahmen 2 Moduln

Ref

1872.A

Dimensions

L364xB225

222x118

build-in

1873/.. - SPINNER X AR70

~12V IP20 1 m 05.10.02



build-in ceiling light - without transformer  
Einbau Deckenleuchte - ohne Trafo

Ref

1873.1M.1M

Lamptype

1873.2.14

QR-LP70 BA15d (3) 50W 12V

1873.11.14

Dimensions

L335xB127xH92

326x118 117

Options

1873/./A - SPINNER X AR70 plasterkit

build-in

1873/./A - SPINNER X AR70 plasterkit

IP20



plasterkit 3 modules  
Einputzrahmen 3 Moduln

Ref

1873.A

Dimensions

L468xB225

326x118

build-in

1874/.. - SPINNER X AR70

~12V 05.10.02



build-in ceiling light - without transformer  
Einbau Deckenleuchte - ohne Trafo

Ref

1874.1M.1M

Lamp type

QR-LP70 BA15d (4) 50W 12V

1874.2.14

1874.11.14

Dimensions

L440xB127xH92

430x118 117

Options

1874/..A - SPINNER X AR70 plasterkit

build-in

1874/..A - SPINNER X AR70 plasterkit

IP20

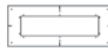

plasterkit 4 modules  
Einputzrahmen 4 Moduln

Ref

1874.A

Dimensions

L572xB225

430x118

build-in

1879/.. - SPINNER X AR70

~12V 05.10.02



build-in ceiling light - without transformer  
Einbau Deckenleuchte - ohne Trafo

Ref

1879.1M.1M

Lamp type

QR-LP70 BA15d (4) 50W 12V

1879.2.14

1879.11.14

Dimensions

L242xB242xH95

233x233 120

Options/Optionen

1879/..A - SPINNER X AR70 plasterkit

build-in

1879/..A - SPINNER X AR70 plasterkit

IP20

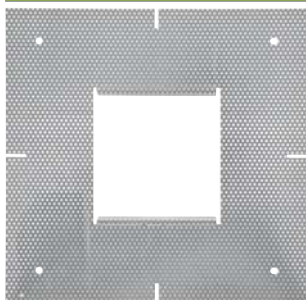

plasterkit  
Einputzrahmen

Ref

1879.A

Dimensions

L375xB375

234x234

build-in

1875/.. - SPINNER X AR70

~230V



build-up ceiling light - with transformer  
Aufbau Deckenleuchte - mit Trafo

Ref

1875.1M.1M

Lamp type

⊲ QR-LP70 BA15d (1) 50W 12V

1875.11M.2.14

Dimensions

↔ L123xB123xH130

build-up  
60VA - chrome on request  
Chrom auf Anfrage

1876/.. - SPINNER X AR70

~230V



build-up ceiling light - with transformer  
Aufbau Deckenleuchte - mit Trafo

Ref

1876.1M.1M

Lamp type

⊲ QR-LP70 BA15d (2) 50W 12V

1876.11M.2.14

Dimensions

↔ L226xB123xH130

build-up  
105VA - chrome on request  
Chrom auf Anfrage

1877/.. - SPINNER X AR70

~230V



build-up ceiling light - with transformer  
Aufbau Deckenleuchte - mit Trafo

Ref

1877.1M.1M

Lamp type

⊲ QR-LP70 BA15d (3) 50W 12V

1877.11M.2.14

Dimensions

↔ L330xB123xH130

build-up  
2x105VA - chrome on request  
Chrom auf Anfrage

1878/.. - SPINNER X AR70

~230V



build-up ceiling light - with transformer  
Aufbau Deckenleuchte - mit Trafo

Ref

1878.1M.1M

Lamp type

⊲ QR-LP70 BA15d (4) 50W 12V

1878.11M.2.14

Dimensions

↔ L434xB123xH130

build-up  
2x105VA - chrome on request  
Chrom auf Anfrage

1880/.. - SPINNER X AR70

~230V  IP20    



build-up ceiling light - with transformer  
Aufbau Deckenleuchte - mit Trafo

Ref

1880.1M.1M  
1880.11M.2.14

Lamp type

QR-LP70 BA15d (4) 50W 12V

Dimensions

L238xB238xH130

build-up  
2x105VA - chrome on request  
Chrom auf Anfrage

1851/.. - SPINNER X

~12V   IP20    1 m  



build-in ceiling light - without transformer  
Einbau Deckenleuchte - ohne Trafo

Ref

1851.1M.1M  
1851.2.14  
1851.11.14

Lamp type

QR-LP111 G53 (1) 50W 12V

Dimensions

L160xB160xH95

152x152 120

Options

1851/..A - SPINNER X plasterkit

build-in

1851/..A - SPINNER X plasterkit

IP20    

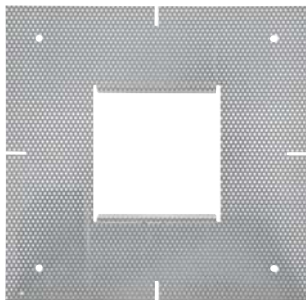

plasterkit 1 module  
Einputzrahmen 1 Modul

Ref

1851.A

Dimensions

L300xB300

152x152

build-in

1852/.. - SPINNER X

~12V   IP20    1 m  



build-in ceiling light - without transformer  
Einbau Deckenleuchte - ohne Trafo

Ref

1852.1M.1M  
1852.2.14  
1852.11.14

Lamp type

QR-LP111 G53 (2) 50W 12V

Dimensions

L306xB160xH95

298x152 120

Options

1852/..A - SPINNER X plasterkit

build-in

1852/..A - SPINNER X plasterkit

IP20    0.2100 

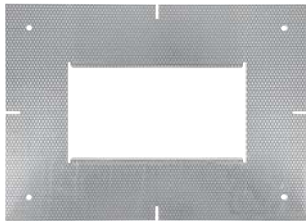

plasterkit 2 modules  
Einputzrahmen 2 Moduln

Ref

1852.A

Dimensions

 L300xB450

 298x152

build-in

1853/.. - SPINNER X

~12V   IP20    1,9633  05.10.02 



build-in ceiling light - without transformer  
Einbau Deckenleuchte - ohne Trafo

Ref

1853.1M.1M

1853.2.14

1853.11.14

Lamp type

 QR-LP111 G53 (3) 50W 12V

Dimensions

 L455xB160xH95

 446x152  120

Options

1853/..A - SPINNER X plasterkit

build-in

1853/..A - SPINNER X plasterkit

IP20    0.2700 

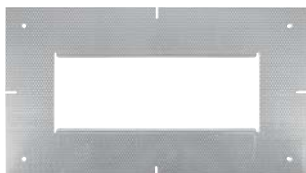

plasterkit 3 modules  
Einputzrahmen 3 Moduln

Ref

1853.A

Dimensions

 L597xB300

 446x152

build-in

1859/.. - SPINNER X

~12V   IP20    1 m  



build-in ceiling light - without transformer  
Einbau Deckenleuchte - ohne Trafo

Ref

1859.1M.1M

1859.2.14

1859.11.14

Lamp type

 QR-LP111 G53 (4) 50W 12V

Dimensions

 L312xB312xH95

 303x303  120

Options

1859/..A - SPINNER X plasterkit

build-in



1859/..A - SPINNER X plasterkit

IP20   

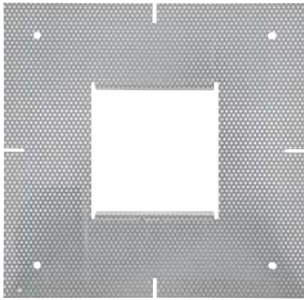

plasterkit  
Einputzrahmen

Ref

1859.A

Dimensions

 L450xB450

 304x304

build-in

1854/.. - SPINNER X

~230V   IP20    1 m  



build-in ceiling light - without gear  
Einbau Deckenleuchte - ohne Vorschaltgerät

Ref

1854.1M.1M

Lamptype

 HIR-CE111 GX8,5 (1) 70W 230V



or  HIR-CE111 GX8,5 (1) 35W 230V

1854.2.14

1854.11.14

Dimensions

 L160xB160xH140

 152x152  165

Options

1851/..A - SPINNER X plasterkit

build-in

1855/.. - SPINNER X

~230V   IP20    1 m  



build-in ceiling light - without gear  
Einbau Deckenleuchte - ohne Vorschaltgerät

Ref

1855.1M.1M

Lamptype

 HIR-CE111 GX8,5 (2) 70W 230V

or  HIR-CE111 GX8,5 (2) 35W 230V

1855.2.14

1855.11.14

Dimensions

 L306xB160xH140

 298x152  165

Options

1852/..A - SPINNER X plasterkit

build-in

1856/.. - SPINNER X

~230V   IP20    1 m  



build-in ceiling light - without gear  
Einbau Deckenleuchte - ohne Vorschaltgerät

Ref

1856.1M.1M

Lamptype

 HIR-CE111 GX8,5 (3) 70W 230V

or  HIR-CE111 GX8,5 (3) 35W 230V

1856.2.14

1856.11.14

Dimensions

 L455xB160xH140

 446x152  165

Options

1853/..A - SPINNER X plasterkit

build-in

1857/.. - SPINNER X

~230V   IP20    1 m  







build-in ceiling light - with glass - without gear  
Einbau Deckenleuchte - mit Glas - ohne Vorschaltgerät

**Ref**  
1857.1M.1M  
1857.2.14  
1857.11.14

**Lamptype**

 HIT-CE G12 (1) 70W 230V  
or  HIT-CE G12 (1) 35W 230V

**Dimensions**

 L160xB160xH160  35° reflector  
 152x152  180

**Options**

1851/..A - SPINNER X plasterkit

*build-in  
other °angle reflector on demand  
andere °Winkel Reflektor auf Anfrage*

1858/.. - SPINNER X

~230V   IP20    1 m  





build-in ceiling light - with glass - without gear  
Einbau Deckenleuchte - mit Glas - ohne Vorschaltgerät

**Ref**  
1858.1M.1M  
1858.2.14  
1858.11.14

**Lamptype**

 HIT-CE G12 (2) 70W 230V  
or  HIT-CE G12 (2) 35W 230V

**Dimensions**

 L306xB160xH160  35° reflector  
 298x152  180

**Options**

1852/..A - SPINNER X plasterkit

*build-in  
other °angle reflector on demand  
andere °Winkel Reflektor auf Anfrage*

1861/.. - SPINNER X

~230V   IP20    1,5250 1 m  



build-up ceiling light - with transformer  
Aufbau Deckenleuchte - mit Trafo

**Ref**  
1861.1M.1M  
1861.2M.2.14  
1861.11M.2.14

**Lamptype**

 QR-LP111 G53 (1) 50W 12V

**Dimensions**

 L155xB155xH126

*build-up  
105VA - colour chrome on request  
Farbe Chrom auf Anfrage*

1862/.. - SPINNER X

~230V   IP20    3,6400 1 m  



build-up ceiling light - with transformer  
Aufbau Deckenleuchte - mit Trafo

**Ref**  
1862.1M.1M  
1862.2M.2.14  
1862.11M.2.14

**Lamptype**

 QR-LP111 G53 (2) 50W 12V

**Dimensions**

 L301xB155xH126

*build-up  
105VA - colour chrome on request  
Farbe Chrom auf Anfrage*

1863/.. - SPINNER X

~230V   IP20    3,6017 1 m 05.10.02 

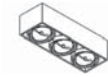

build-up ceiling light - with transformer  
Aufbau Deckenleuchte - mit Trafo

**Lamp type**

 QR-LP111 G53 (3) 50W 12V

**Dimensions**

 L448xB155xH126

**Ref**

1863.1M.1M  
1863.2M.2.14  
1863.11M.2.14

*build-up*  
2x105VA - colour chrome on request  
Farbe Chrom auf Anfrage

1868/.. - SPINNER X

~230V   IP20    05.10.02 



build-up ceiling light - with transformer  
Aufbau Deckenleuchte - mit Trafo

**Lamp type**

 QR-LP111 G53 (4) 50W 12V

**Dimensions**

 L308xB308xH130

**Ref**

1868.1M.1M  
1868.2M.2.14  
1868.11M.2.14

*build-up*  
2x105VA - colour chrome on request  
Farbe Chrom auf Anfrage

1864/.. - SPINNER X

~230V   IP20    1 m 05.10.50 



build-up ceiling light - with electronic gear  
Aufbau Deckenleuchte - mit elektronischem Vorschaltgerät

**Lamp type**

 HIR-CE111 GX8,5 (1) 70W 230V  
or  HIR-CE111 GX8,5 (1) 35W 230V

**Dimensions**

 L276xB155xH150

**Ref**

1864.1M.1M  
1864.2M.2.14  
1864.11M.2.14

*build-up*  
colour chrome on request  
Farbe Chrom auf Anfrage

1865/.. - SPINNER X

~230V   IP20    1 m 05.10.50 



build-up ceiling light - with electronic gear  
Aufbau Deckenleuchte - mit elektronischem Vorschaltgerät

**Lamp type**

 HIR-CE111 GX8,5 (2) 70W 230V  
or  HIR-CE111 GX8,5 (2) 35W 230V

**Dimensions**

 L424xB155xH150

**Ref**

1865.1M.1M  
1865.2M.2.14  
1865.11M.2.14

*build-up*  
colour chrome on request  
Farbe Chrom auf Anfrage

1866/.. - SPINNER X

~230V  IP20    1 m  





build-up ceiling light - with glass - with electronic gear  
 Aufbau Deckenleuchte - mit Glas - mit elektronischem  
 Vorschaltgerät

**Lamptype**

 HIT-CE G12 (1) 70W 230V  
 or  HIT-CE G12 (1) 35W 230V

**Dimensions**

 L276xB155xH150  35° reflector

**Ref**

1866.1M.1M  
 1866.2M.2.14  
 1866.11M.2.14

build-up  
 colour chrome on request  
 Farbe Chrom auf Anfrage

1867/.. - SPINNER X

~230V  IP20    1,9433 1 m  





build-up ceiling light - with glass - with electronic gear  
 Aufbau Deckenleuchte - mit Glas - mit elektronischem  
 Vorschaltgerät

**Lamptype**

 HIT-CE G12 (2) 70W 230V  
 or  HIT-CE G12 (2) 35W 230V

**Dimensions**

 L424xB155xH150  35° reflector

**Ref**

1867.1M.1M  
 1867.2M.2.14  
 1867.11M.2.14

build-up  
 colour chrome on request  
 Farbe Chrom auf Anfrage

950/.. - SPINNER

~12V   IP20    1,8000 1 m  





build-in ceiling light - directional - without transformer  
 Einbau Deckenleuchte - schwenkbar - ohne Trafo

**Lamptype**

 QR-LP111 G53 (1) 50W 12V  
 PAR 36 screw (1) 50W 12V

**Dimensions**

 L214xB210xH85  
 198x198  105

**Ref**

950.1M  
 950.14

build-in

952/.. - SPINNER

~12V   IP20    2,7075 1 m  





build-in ceiling light - directional - without transformer  
 Einbau Deckenleuchte - schwenkbar - ohne Trafo

**Lamptype**

 QR-LP111 G53 (2) 50W 12V  
 PAR 36 screw (2) 50W 12V

**Dimensions**

 L355xB214xH87  
 340x198  105

**Ref**

952.1M  
 952.14

build-in

1445/.. - SPINNER

~12V 5,8400 1 m 05.10.02



build-in ceiling light - directional - without transformer  
Einbau Deckenleuchte - schwenkbar - ohne Trafo

Ref

1445.1M

1445.14

Lamp type

QR-LP111 G53 (3) 50W 12V  
or PAR 36 screw (3) 50W 12V

Dimensions

L500xB215xH200  
 485x200 220

build-in

958/.. - SPINNER CDMT

~230V 2,7000 1 m 05.10.50



build-in ceiling light - directional - without gear  
Einbau Deckenleuchte - schwenkbar - ohne Vorschaltgerät

Ref

958.1M

958.14

Lamp type

HIT-CE G12 (1) 70W 230V  
or HIT-CE G12 (1) 35W 230V

Dimensions

L214xB210xH150 35° reflector  
 198x198 170

build-in  
other °angle reflector on demand  
andere °Winkel Reflektor auf Anfrage

959/.. - SPINNER CDMT

~230V 3,8000 1 m 05.10.50



build-in ceiling light - directional - without gear  
Einbau Deckenleuchte - schwenkbar - ohne Vorschaltgerät

Ref

959.1M

959.14

Lamp type

HIT-CE G12 (2) 70W 230V  
or HIT-CE G12 (2) 35W 230V

Dimensions

L355xB214xH150 35° reflector  
 340x198 170

build-in  
other °angle reflector on demand  
andere °Winkel Reflektor auf Anfrage

1446/.. - SPINNER

~230V 5,9900 1 m 05.10.50



build-in ceiling light - directional - without gear  
Einbau Deckenleuchte - schwenkbar - ohne Vorschaltgerät

Ref

1446.1M

1446.14

Lamp type

HIR-CE111 GX8,5 (3) 70W 230V  
or HIR-CE111 GX8,5 (3) 35W 230V

Dimensions

L500xB215xH200  
 485x200 220

build-in

1447/.. - SPINNER

~12V/~230V    IP20    5,9400 1 m 05.10.50 



build-in ceiling light - directional - without transformer - without gear  
Einbau Deckenleuchte - schwenkbar - ohne Trafo - ohne Vorschaltgerät



Ref

1447.1M  
1447.14

Lamp type

 QR-LP111 G53 (1) 50W 12V  
 HIR-CE111 GX8,5 (2) 70W 230V

Dimensions

 L500xB215xH200  
 485x200  220

build-in

1448/.. - SPINNER

~12V/~230V    IP20    5,9900 1 m 05.10.50 





build-in ceiling light - directional - without transformer - without gear  
Einbau Deckenleuchte - schwenkbar - ohne Trafo - ohne Vorschaltgerät



Ref

1448.1M  
1448.14

Lamp type

 QR-LP111 G53 (2) 50W 12V  
 HIR-CE111 GX8,5 (1) 70W 230V

Dimensions

 L500xB215xH200  
 485x200  220

build-in

960/.. - SPINNER

 IP20  0,2930 



gear - CDM-T electronic gear tridonic HIT 35W type  
PCI0035B011 - with electronic gear  
Vorschaltgerät - CDM-T elektronisches Vorschaltgerät  
tridonic HIT 35W Typ PCI0035B011 - mit elektronischem Vorschaltgerät

Ref

960

Dimensions

 L90xB60xH28

build-in

960A/.. - SPINNER

 IP20  



gear - CDM-T electronic gear tridonic HIT 35W type  
PCI0035B021 - with electronic gear  
Vorschaltgerät - CDM-T elektronisches Vorschaltgerät  
tridonic HIT 35W Typ PCI0035B021 - mit elektronischem Vorschaltgerät

Ref

960A

Dimensions

 L150xB80xH33

build-up  
with housing + strain relief  
mit Gehäuse + Zugentlastung

961/.. - SPINNER

[EVG] IP20 0.3220 CE



supplement - CDM-T electronic gear tridonic HIT 70W type  
PCI0070B011 - with electronic gear  
Supplement - CDM-T elektronisches Vorschaltgerät  
tridonic HIT 70W Typ PCI0070B011 - mit elektronischem  
Vorschaltgerät

Ref

961

Dimensions

↔ L100xB75xH28

build-in

961A/.. - SPINNER

[EVG] IP20 CE



gear - CDM-T electronic gear tridonic HIT 70W type  
PCI0070B021 - with electronic gear  
Vorschaltgerät - CDM-T elektronisches Vorschaltgerät  
tridonic HIT 70W Typ PCI0070B021 - mit elektronischem  
Vorschaltgerät

Ref

961A

Dimensions

↔ L150xB80xH33

build-up  
with housing + strain relief  
mit Gehäuse + Zugentlastung

970/.. - SPINNER ETALAGE

~230V [EVG] IP20 0.9500 1m 05.10.50 CE



build-in ceiling light - without gear  
Einbau Deckenleuchte - ohne Vorschaltgerät

Ref

970.14

Lamp type

↔ HIT-CE G12 (1) 70W 230V  
or ↔ HIT-CE G12 (1) 35W 230V

Dimensions

↔ L250xB90xH132

↙ 236x75 ↘ 140

build-in

1254/.. - QUADRO

~230V [EVG] IP20 0.5m 05.10.50 CE



build-in ceiling light - with electronic gear  
Einbau Deckenleuchte - mit elektronischem Vorschaltgerät

Ref

1254.1

Lamp type

↔ TC-TEL GX24Q-3 (2) 26W 230V

Dimensions

↔ L250xB250xH150

↙ 220x220 ↘ 170

build-in  
2x32W on request  
auf Anfrage

1255/.. - QUADRO

~230V



build-in ceiling light - dimmable - with electronic dimmable gear  
 Einbau Deckenleuchte - abblendbar - mit elektronischem abblendbaren Vorschaltgerät

Ref

1255.1  
 1255.11

Lamp type

TC-TEL GX24Q-3 (2) 26W 230V

Dimensions

L250xB250xH150  
 220x220 170

build-in  
 2x32W on request  
 auf Anfrage

1256/.. - QUADRO

~230V



build-in ceiling light - with magnetic gear  
 Einbau Deckenleuchte - mit magnetischem Vorschaltgerät

Ref

1256.1  
 1256.11

Lamp type

TC-D G24D-3 (2) 26W 230V

Dimensions

L250xB250xH150  
 220x220 170

build-in

1253/.. - QUADRO

~230V



build-in ceiling light - with glass - with magnetic gear  
 Einbau Deckenleuchte - mit Glas - mit magnetischem Vorschaltgerät

Ref

1253.1  
 1253.11

Lamp type

TC-D G24D-3 (2) 26W 230V

Dimensions

L250xB250xH150  
 220x220 170

build-in  
 standard with sandblasted glass  
 standard mit sandgestrahltem Glas

1257/.. - QUADRO

~230V



build-in ceiling light - with glass - with electronic gear  
 Einbau Deckenleuchte - mit Glas - mit elektronischem Vorschaltgerät

Ref

1257.1  
 1257.11

Lamp type

TC-TEL GX24Q-3 (2) 26W 230V

Dimensions

L250xB250xH150  
 220x220 170

build-in  
 2x32W on request - standard with sandblasted glass  
 auf Anfrage - standard mit sandgestrahltem Glas



1258/.. - QUADRO

~230V



build-in ceiling light - dimmable - with glass - with electronic dimmable gear  
 Einbau Deckenleuchte - abblendbar - mit Glas - mit elektronischem abblendbarem Vorschaltgerät

Ref

1258.1  
 1258.11

Lamptype

TC-TEL GX24Q-3 (2) 26W 230V

Dimensions

L250xB250xH150  
 220x220 170

build-in  
 2x32W on request - standard with sandblasted glass  
 auf Anfrage - standard mit sandgestrahltem Glas

1520.7W/.. - SNOWBOX

~230V



build-in ceiling light  
 Einbau Deckenleuchte

Ref

1520.7W.1M

Lamptype

TC-FSE GX53 (1) 6W 230V

Dimensions

L160xB160xH80  
 145x145 100

build-in

1520.13W/.. - SNOWBOX

~230V



build-in ceiling light - with electronic gear  
 Einbau Deckenleuchte - mit elektronischem Vorschaltgerät

Ref

1520.13W.1M

Lamptype

TC-TEL GX24Q-1 (1) 13W 230V

Dimensions

L160xB160xH145  
 145x145 165

build-in

1520.26W/.. - SNOWBOX

~230V



build-in ceiling light - with electronic gear  
 Einbau Deckenleuchte - mit elektronischem Vorschaltgerät

Ref

1520.26W.1M

Lamptype

TC-TEL GX24Q-3 (1) 26W 230V

Dimensions

L200xB200xH175  
 160x160 195

build-in

1520.42W/.. - SNOWBOX

~230V  S4 IP20     



build-in ceiling light - with electronic gear  
Einbau Deckenleuchte - mit elektronischem Vorschaltgerät

Ref  
1520.42W.1M

**Lamptype**

TC-TEL GX24Q-4 (1) 42W 230V

**Dimensions**

L270xB270xH225  
220x220 245

build-in

1522.13W/.. - SNOWBOX

~230V  S1 IP20     



build-in ceiling light - with electronic gear  
Einbau Deckenleuchte - mit elektronischem Vorschaltgerät

Ref  
1522.13W.1M

**Lamptype**

TC-TEL GX24Q-1 (2) 13W 230V

**Dimensions**

L265xB160xH145  
235x145 165

build-in

1522.26W/.. - SNOWBOX

~230V  S4 IP20      



build-in ceiling light - with electronic gear  
Einbau Deckenleuchte - mit elektronischem Vorschaltgerät

Ref  
1522.26W.1M

**Lamptype**







TC-TEL GX24Q-3 (2) 26W 230V

**Dimensions**

L323xB200xH175  
275x165 195

build-in

1522.42W/.. - SNOWBOX

~230V  S4 IP20     



build-in ceiling light - with electronic gear  
Einbau Deckenleuchte - mit elektronischem Vorschaltgerät

Ref  
1522.42W.1M

**Lamptype**

TC-TEL GX24Q-4 (2) 42W 230V

**Dimensions**

L448xB270xH225  
390x220 245

build-in

945.MT/.. - CAMERA UP

~230V   IP20    0,8875  0,5 m  05.10.02 

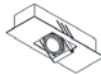

ceiling light - directional - with transformer  
Deckenleuchte - schwenkbar - mit Trafo

Ref

945.MT.14.2

945.MT.14.11

Lamptype

 QR-CB 51 coolfit GU5,3/GX5,3 (1) 35W 12V

Dimensions

 L260xB107xH62

 L230xB75

build-up

60VA - socle black or grey - use coolfit lamp

Sockel Schwarz oder Grau - Coolfit-Lampe verwenden

945./../S1 - CAMERA IN

~12V   S1 IP20    0,7200  0,5 m  05.10.02 



build-in ceiling and wall light - directional - without transformer  
Decken- und Wandleuchte für Einbau - schwenkbar - ohne Trafo

Ref



945.14.S1

Lamptype

 QR-CB 51 coolfit GU5,3/GX5,3 (1) 50W 12V

Dimensions

 L120xB120xH65

 108x108  85

Options

S9.108/.. - PLASTERKIT

build-in

use coolfit lamp

Coolfit-Lampe verwenden

945./../S2 - CAMERA IN

~12V   S2 IP20    0,7300  0,5 m  05.10.02 



build-in ceiling and wall light - directional - without transformer  
Decken- und Wandleuchte für Einbau - schwenkbar - ohne Trafo

Ref

945.14.S2

Lamptype

 QR-CB 51 coolfit GU5,3/GX5,3 (1) 50W 12V

Dimensions

 L120xB120xH65

 108x108  85

Options

945A/.. - CAMERA IN BOX ZT

945B/.. - CAMERA IN BOX VT

S9.108/.. - PLASTERKIT

build-in

use coolfit lamp

Coolfit-Lampe verwenden

945A/.. - CAMERA IN BOX ZT

IP20    0,1270 

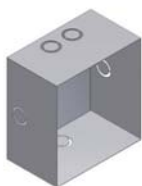

build-in box - no room for transformer  
Einbaudose - kein Platz für Trafo

Ref

945A

Dimensions

 L110xB105xH80

945B/.. - CAMERA IN BOX VT

~230V  IP20    0,1600 



build-in box - with room for transformer  
Einbaudose - mit Platz für Trafo

Ref

945B

Dimensions

↔ L185xB103xH80

946.MT/.. - CAMERA UP

~230V   IP20    1,9700  0,5 m  05.10.02 



ceiling light - directional - with transformer  
Deckenleuchte - schwenkbar - mit Trafo

Ref

946.MT.14.2

946.MT.14.11

Lamp type

☞ QR-CB 51 coolfit GU5,3/GX5,3 (2) 35W 12V

Dimensions

↔ L320xB170xH65

⬆ L250xB100

build-up

2x60VA - socle black or grey - use coolfit lamp

Sockel Schwarz oder Grau - Coolfit-Lampe verwenden

946/.. - CAMERA IN

~12V   S1 IP20    1,0600  0,5 m  05.10.02 



build-in ceiling and wall light - directional - without transformer  
Decken- und Wandleuchte für Einbau - schwenkbar - ohne Trafo

Ref

946.14

Lamp type

☞ QR-CB 51 coolfit GU5,3/GX5,3 (2) 50W 12V

Dimensions

↔ L210xB120xH65

⬆ 198x108 ⬇ 85

Options

S10.198/.. - PLASTERKIT

build-in

use coolfit lamp

Coolfit-Lampe verwenden

948/.. - CAMERA IN

~230V   S1 IP20    3,3000  0,5 m  05.10.02 



build-in ceiling light - directional - with transformer  
Einbau Deckenleuchte - schwenkbar - mit Trafo

Ref

948.14

Lamp type

☞ QR-CB 51 coolfit GU5,3/GX5,3 (4) 35W 12V

Dimensions

↔ L320xB320xH65

⬆ 235x235 ⬇ 85

build-in

2x105VA - use coolfit lamp

Coolfit-Lampe verwenden

949/.. - CAMERA UP

~230V   IP20    3,2125  0,5 m  05.10.02  



ceiling light - directional - with transformer  
Deckenleuchte - schwenkbar - mit Trafo

Ref

949.14.2

Lamptype

 QR-CB 51 coolfit GU5,3/GX5,3 (4) 35W 12V

949.14.11

Dimensions

 L320xB320xH65

 L230xB230

build-up

2x105VA - socle black or grey - use coolfit lamp

Sockel Schwarz oder Grau - Coolfit-Lampe verwenden

947/.. - CAMERA TWIN

~230V   IP20    1,0900  0,5 m  05.10.02  



ceiling light - directional - with base 005 - with transformer  
Deckenleuchte - schwenkbar - mit Rosette 005 - mit Trafo

Ref

947.14

Lamptype

 QR-CB 51 coolfit GU5,3/GX5,3 (2) 35W 12V

Dimensions

 L210xB130xH60

 Ø50

build-up

105VA - use coolfit lamp

Coolfit-Lampe verwenden

947/..B - CAMERA TWIN

~230V   IP20    0,7400  0,5 m  05.10.02  



ceiling light for track - directional - without adaptor M10 -  
with transformer  
Deckenleuchte für Schienensystem - schwenkbar - ohne  
Adapter M10 - mit Trafo

Ref

947.14.B

Lamptype

 QR-CB 51 coolfit GU5,3/GX5,3 (2) 50W 12V

Dimensions

 L210xB130xH60

Options

1456.M10/.. - ADAPTOR

build-up

105VA - use coolfit lamp

Coolfit-Lampe verwenden

1450/.. - RETRO

~230V   IP20    1,0443  1 m  05.10.02  



ceiling light - directional - with transformer  
Deckenleuchte - schwenkbar - mit Trafo

Ref

1450.1M

Lamptype

 QR-LP111 G53 (2) 50W 12V

1450.7.2

Dimensions

 L340xB145xH220

1450.10.2

 L80xB30

build-up

105VA

1451/.. - RETRO

~230V   IP20    1,8957 1 m 05.10.02 



ceiling light - directional - with transformer  
Deckenleuchte - schwenkbar - mit Trafo



Ref

1451.1M  
1451.7.2  
1451.10.2

Lamptype

 QR-LP111 G53 (4) 50W 12V

Dimensions

 L340xB290xH220  
 L180xB80

build-up  
2x105VA

1799/.. - BRIDGE WALL

~230V   IP20    0,6625 1 m 05.10.02 



build-up wall light - with transformer  
Wandleuchte für Aufbau - mit Trafo



Ref

1799.1M  
1799.2M  
1799.2M.7  
1799.11M

Lamptype

 QR-LP111 G53 (2) 50W 12V

Dimensions

 B350xH123xD190  
 B180xH120

build-up  
105VA

1800/.. - BRIDGE PLAFOND

~230V   IP20    0,6663 1 m 05.10.02 



ceiling light - with transformer  
Deckenleuchte - mit Trafo



Ref

1800.1M  
1800.2M  
1800.2M.7  
1800.11M

Lamptype

 QR-LP111 G53 (2) 50W 12V

Dimensions

 L350xB190xH123  
 L180xB40

build-up  
105VA

1475/.. - INCA

~12V   S1 IP20    0,4750 1 m 05.10.02 



downlight - directional - without transformer  
Einbaustrahler - schwenkbar - ohne Trafo



Ref

1475.1M  
1475.14

Lamptype

 QR-LP111 G53 (1) 50W 12V  
 PAR 36 screw (1) 50W 12V

Dimensions

 Ø180xH80  
 Ø162  100

Options

1478B/.. - INCA X plasterkit

build-in

1476/.. - INCA

~230V   S1 IP20    0,5190 1 m 05.10.50 



downlight - directional - without gear  
Einbaustrahler - schwenkbar - ohne Vorschaltgerät

Ref

1476.1M

Lamptype

 HIR-CE111 GX8,5 (1) 70W 230V

1476.14

Dimensions

 Ø180xH120

 Ø162  140

Options

1478B/.. - INCA X plasterkit

build-in

1477/.. - INCA X

~12V   S1 IP20    1 m 05.10.02 



downlight - directional - without transformer  
Einbaustrahler - schwenkbar - ohne Trafo

Ref



1477.1M

Lamptype

 QR-LP111 G53 (1) 50W 12V

Dimensions

 Ø170xH115

 Ø162  135

Options

1478B/.. - INCA X plasterkit

build-in

1478/.. - INCA X

~230V   S1 IP20    0,4600 1 m  



downlight - directional - without gear  
Einbaustrahler - schwenkbar - ohne Vorschaltgerät

Ref

1478.1M

Lamptype

 HIR-CE111 GX8,5 (1) 35W 230V

Dimensions

 Ø170xH170

 Ø162  190

Options

1478B/.. - INCA X plasterkit

build-in

1478B/.. - INCA X plasterkit

IP20   

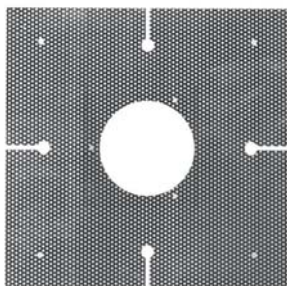

plasterkit  
Einputzrahmen

Ref

1478B

Dimensions

 L305xB305

 Ø162

build-in



1480/.. - QUORUM

~230V    IP20    1,6750  1 m  





downlight - directional - without transformer - with electronic gear  
Einbaustrahler - schwenkbar - ohne Trafo - mit elektronischem Vorschaltgerät

Ref  
1480.14

Lamptype

-  QR-LP111 G53 (1) 50W 12V
-  TL16-R 2GX13 (1) 22W 230V

Dimensions

 Ø290xH140  
 Ø255  160

build-in

1481/.. - QUORUM

~230V    IP20    1 m  





downlight - directional - with transformer - with electronic gear  
Einbaustrahler - schwenkbar - mit Trafo - mit elektronischem Vorschaltgerät

Ref  
1481.14

Lamptype

-  QR-LP111 G53 (1) 50W 12V
-  TL16-R 2GX13 (1) 22W 230V

Dimensions

 Ø290xH140  
 Ø255  160

build-in



1483/.. - QUORUM

~230V   IP20      





downlight - directional - with electronic gear  
Einbaustrahler - schwenkbar - mit elektronischem  
Vorschaltgerät

Ref  
1483.14

Lamp type

-  HIR-CE111 GX8,5 (1) 35W 230V
-  TL16-R 2GX13 (1) 22W 230V

Dimensions

-  Ø290xH140
-  Ø255  160

build-in

1484/.. - QUORUM

~230V   IP20      





downlight - directional - with electronic gear  
Einbaustrahler - schwenkbar - mit elektronischem  
Vorschaltgerät

Ref  
1484.14

Lamp type

-  HIR-CE111 GX8,5 (1) 70W 230V
-  TL16-R 2GX13 (1) 22W 230V

Dimensions

-  Ø290xH140
-  Ø255  160

build-in

Architectural lighting indoor





Torpedo is een enkel- of tweevoudig richtbaar verlichtingsarmatuur voor QR111 of CDM-R111, met of zonder 3W powerled, voor inbouw of opbouw.

De voeding voor de LED is in het armatuur geïntegreerd. De transfo voor de QR111 moet apart worden voorzien. Door het gebruik van het systeem met twee afzonderlijke voedingen, wordt de Torpedo bijzonder functioneel voor bv. etalages. Het armatuur kan zowel als dag- als nachtverlichting worden ingeschakeld.

Overdag kan een bepaald artikel in de winkel met bv. QR111 perfect uitgelicht worden. 's Nachts doet de 3W powerled zijn werk en maakt de etalage voldoende zichtbaar, wat een gevoel van veiligheid creëert. QR111

Lamp en LED mogen vanwege gevaar voor oververhitting niet samen aangeschakeld worden.

Torpedo est une gamme d'appiques et plafonniers orientables, créés pour les magasins et les étalages. Le Torpedo existe en différentes versions: avec QR111 ou CDM-R111, avec ou sans 3W powerled, encastrable ou apparent.

L'alimentation pour la LED est incorporée dans le luminaire, le transfo pour le QR111 ou CDM-R111 doit être prévu séparément.

Torpedo offre la fonctionnalité maximale aux utilisateurs: le CDM-R111 ou QR111 sera mis en circuit pendant la journée, alors que la LED illuminera la même espace durant la nuit sans causer des factures d'électricité énormes. L'utilisation des LEDs est même double: elles vous donneront de la sécurité, sachant que votre magasin est bien illuminé pendant la nuit et les passants remarqueront votre étalage, même le soir ou la nuit.

Il faut quand même remarquer que l'ampoule et le LED ne peuvent jamais être allumées ensemble, pour éviter la risque de surchauffer l'armature.

Torpedo is a range of directional wall and ceiling lights, designed especially for shops and shop windows. The fixture comes in different versions: QR111 or CDM-R111, with or without 3W powerled, to build up or to build in.

The driver for the LED is included in the fixture. The transformer for the QR111 has to be foreseen separately. Torpedo offers maximum functionality to its users: the CDM-R or QR111 will be switched on during the day while as the LED will illuminate the same space at night, without causing enormous energy bills. The use of the LEDs at night is twofold: it will provide you with a feeling of security knowing your shop or shop window is indeed lit and it will catch the eye of passers-by even if it is still dark.

Do notice that the light bulb and the LED can never be switched on together, because of the risk of overheating the luminaire.

Torpedo ist eine Reihe von einfachen und doppelten schwenkbaren Leuchten für Geschäfte und Schaufenster. Der Torpedo gibt es in verschiedenen Versionen: QR111 oder CDM-R111, mit oder ohne 3W Powerled, als Einbau- oder Aufbauleuchte.

Das Vorschaltgerät für die LED ist in der Leuchte integriert, Trafo für QR111 oder CDM-R111 soll separat vorausgesehen werden. Torpedo bietet dem Benutzer maximale Funktionalität: die CDM-R111 oder QR111 wird während des Tages eingeschaltet. Der LED beleuchtet Abends und Nachts den gleichen Raum ohne dabei riesengroße Energierechnungen zu verursachen. Die Verwendung der LEDs Nachts ist zweifach: wissen, dass Ihr Geschäft oder Schaufenster Nachts beleuchtet wird, leistet Ihnen ein Sicherheitsgefühl und ein beleuchtetes Schaufenster sticht bei Passanten ins Auge.

Bemerken Sie aber wohl, dass die Lampe und die LED niemals zusammen eingeschaltet werden dürfen wegen der Risiken auf Überhitzung.



Never switch on light bulb and LED together, due to risk of overheating!  
Lampe und LED wegen Risiken auf Überhitzung nicht zusammen einschalten!



1490/.. - TORPEDO

~12V S2 IP20



build-in ceiling light - directional - without transformer  
Einbau Deckenleuchte - schwenkbar - ohne Trafo

Ref

1490.1M

1490.14

Lamp type

QR-LP111 G53 (1) 50W 12V

Dimensions

Ø200xH85  
 Ø180 100

build-in

1490LED/.. - TORPEDO

~12V/~230V S2 IP20



build-in ceiling light - directional - without transformer - with LED driver  
Einbau Deckenleuchte - schwenkbar - ohne Trafo - mit Driver LED

Ref

1490LED.1M

1490LED.14

Lamp type

QR-LP111 G53 (1) 50W 12V  
 poweredled 700mA . (1) 3W 700mA

Dimensions

Ø200xH85  
 Ø180 100

build-in

## INDOOR | Architectural | TORPEDO

Never switch on light bulb and LED together, due to risk of overheating!

Lampe und LED wegen Risiken auf Überhitzung nicht zusammen einschalten!

### 1491/.. - TORPEDO

~230V



S2

IP20



build-in ceiling light - directional - without gear  
Einbau Deckenleuchte - schwenkbar - ohne Vorschaltgerät

#### Lamptype

HIR-CE111 GX8,5 (1) 70W 230V

#### Dimensions

Ø200xH100

Ø180 √L 120

#### Ref

1491.1M

1491.14

build-in

### 1491LED/.. - TORPEDO

~230V



S2

IP20



build-in ceiling light - directional - without gear - with LED driver  
Einbau Deckenleuchte - schwenkbar - ohne Vorschaltgerät - mit Driver LED

#### Lamptype

HIR-CE111 GX8,5 (1) 70W 230V

powered 700mA . (1) 3W 700mA

#### Dimensions

Ø200xH100

Ø180 √L 120

#### Ref

1491LED.1M

1491LED.14

build-in

### 1492/.. - TORPEDO

~12V



S2

IP20



build-in ceiling light - directional - without transformer  
Einbau Deckenleuchte - schwenkbar - ohne Trafo

#### Lamptype

QR-LP111 G53 (2) 50W 12V

#### Dimensions

L375xB200xH85

Ø2x180 √L 100 ⌀ [175]

#### Ref

1492.1M

1492.14

build-in

### 1492LED/.. - TORPEDO

~12V/~230V



S2

IP20



build-in ceiling light - directional - without transformer - with LED driver  
Einbau Deckenleuchte - schwenkbar - ohne Trafo - mit Driver LED

#### Lamptype

QR-LP111 G53 (2) 50W 12V

powered 700mA . (2) 3W 700mA

#### Dimensions

L375xB200xH85

Ø2x180 √L 100 ⌀ [175]

#### Ref

1492LED.1M

1492LED.14

build-in

Never switch on light bulb and LED together, due to risk of overheating!  
Lampe und LED wegen Risiken auf Überhitzung nicht zusammen einschalten!

1493/.. - TORPEDO

~230V   S2 IP20    1 m  05.10.50 



build-in ceiling light - directional - without gear  
Einbau Deckenleuchte - schwenkbar - ohne Vorschaltgerät

Ref





1493.1M

1493.14

Lamp type

 HIR-CE111 GX8,5 (2) 70W 230V

Dimensions

 L375xB200xH100  
 Ø2x180  120  [175]

build-in

1493LED/.. - TORPEDO

~230V    S2 IP20    1,3875 1 m  05.10.50 



build-in ceiling light - directional - without gear - with LED driver  
Einbau Deckenleuchte - schwenkbar - ohne Vorschaltgerät - mit Driver LED

Ref



1493LED.1M

1493LED.14

Lamp type

 HIR-CE111 GX8,5 (2) 70W 230V  
 powered 700mA . (2) 3W 700mA

Dimensions

 L375xB200xH100  
 Ø2x180  120  [175]

build-in

1494/.. - TORPEDO

~12V   S1 IP20    0,7650 1 m  05.10.02 



build-in base with build-up spot - directional - without transformer  
Einbaubasis mit Aufbaustrahler - schwenkbar - ohne Trafo

Ref

1494.1M

1494.14

Lamp type









 QR-LP111 G53 (1) 50W 12V

Dimensions

 Ø124xH95-170  
 Ø75  40

semi build in/up  
socle Ø90xH10  
Sockel Ø90xH10

1494LED/.. - TORPEDO

~12V/~230V    S1 IP20    0,8940 1 m  05.10.02 



build-in base with build-up spot - directional - without transformer - with LED driver  
Einbaubasis mit Aufbaustrahler - schwenkbar - ohne Trafo - mit Driver LED

Ref



1494LED.1M

1494LED.14

Lamp type

 QR-LP111 G53 (1) 50W 12V  
 powered 700mA . (1) 3W 700mA

Dimensions

 Ø124xH95-170  
 Ø75  40

semi build in/up  
socle Ø90xH10  
Sockel Ø90xH10

## INDOOR | Architectural | TORPEDO

Never switch on light bulb and LED together, due to risk of overheating!

Lampe und LED wegen Risiken auf Überhitzung nicht zusammen einschalten!

### 1495/.. - TORPEDO

~230V   S1 IP20    0,8100 1 m 05.10.50 



build-in base with build-up spot - directional - without gear  
Einbaubasis mit Aufbaustrahler - schwenkbar - ohne  
Vorschaltgerät

#### Ref

1495.1M

1495.14

#### Lamptype

 HIR-CE111 GX8,5 (1) 70W 230V

#### Dimensions

 Ø124xH95-170

 Ø75  40

semi build in/up  
socle Ø90xH10  
Sockel Ø90xH10

### 1495LED/.. - TORPEDO

~230V    S1 IP20    0,7550 1 m 05.10.50 



build-in base with build-up spot - directional - without gear -  
with LED driver  
Einbaubasis mit Aufbaustrahler - schwenkbar - ohne  
Vorschaltgerät - mit Driver LED

#### Ref

1495LED.1M

1495LED.14

#### Lamptype

 HIR-CE111 GX8,5 (1) 70W 230V

 powered 700mA . (1) 3W 700mA

#### Dimensions

 Ø124xH95-170

 Ø75  40

semi build in/up  
socle Ø90xH10  
Sockel Ø90xH10

### 1496/.. - TORPEDO

~230V   IP20    0,6800 1 m 05.10.02 



ceiling light - directional - with transformer  
Deckenleuchte - schwenkbar - mit Trafo

#### Ref

1496.1M

1496.14

#### Lamptype

 QR-LP111 G53 (1) 50W 12V

#### Dimensions

 Ø124xH185-255

 Ø90xH98

build-up  
60VA

### 1496LED/.. - TORPEDO

~230V    IP20    1 m 05.10.02 



ceiling light - directional - with transformer - with LED driver  
Deckenleuchte - schwenkbar - mit Trafo - mit Driver LED

#### Ref

1496LED.1M

1496LED.14

#### Lamptype

 QR-LP111 G53 (1) 50W 12V

 powered 700mA . (1) 3W 700mA

#### Dimensions

 Ø124xH185-255

 Ø90xH98

build-up  
60VA

Never switch on light bulb and LED together, due to risk of overheating!  
Lampe und LED wegen Risiken auf Überhitzung nicht zusammen einschalten!

1497/.. - TORPEDO

~230V   IP20    0,6525 1 m 05.10.50 



ceiling light - directional - with electronic gear  
Deckenleuchte - schwenkbar - mit elektronischem  
Vorschaltgerät

Ref

1497.1M

1497.14

Lamptype

 HIR-CE111 GX8,5 (1) 35W 230V

Dimensions

 Ø124xH185-255

 Ø90xH134

build-up

1497LED/.. - TORPEDO

~230V    IP20    1,4300 1 m 05.10.50 



ceiling light - directional - with electronic gear - with LED  
driver  
Deckenleuchte - schwenkbar - mit elektronischem  
Vorschaltgerät - mit Driver LED

Ref

1497LED.1M

1497LED.14

Lamptype

 HIR-CE111 GX8,5 (1) 35W 230V

 powered 700mA . (1) 3W 700mA

Dimensions

 Ø124xH185-255

 Ø90xH134

build-up

1498/.. - TORPEDO

~230V   IP20    1,3925 1 m 05.10.02 



ceiling light - directional - with transformer  
Deckenleuchte - schwenkbar - mit Trafo

Ref

1498.1M

1498.14

Lamptype

 QR-LP111 G53 (2) 50W 12V

Dimensions

 L455xB124xH150-215

 L255xB90xH60

build-up  
105VA

1498LED/.. - TORPEDO

~230V    IP20    2,9080 1 m 05.10.02 



ceiling light - directional - with transformer - with LED driver  
Deckenleuchte - schwenkbar - mit Trafo - mit Driver LED

Ref

1498LED.1M

1498LED.14

Lamptype

 QR-LP111 G53 (2) 50W 12V

 powered 700mA . (2) 3W 700mA

Dimensions

 L445xB124xH150-215

 L255xB90xH60

build-up  
105VA

## INDOOR | Architectural | TORPEDO | OPERA

Never switch on light bulb and LED together, due to risk of overheating!  
Lampe und LED wegen Risiken auf Überhitzung nicht zusammen einschalten!

### 1499/.. - TORPEDO

~230V



ceiling light - directional - with electronic gear  
Deckenleuchte - schwenkbar - mit elektronischem  
Vorschaltgerät

#### Ref

1499.1M

1499.14

#### Lamptype

⚡ HIR-CE111 GX8,5 (2) 35W 230V

#### Dimensions

↔ L445xB124xH150-215

⤴ L255xB90xH60

build-up

### 1499LED/.. - TORPEDO

~230V



ceiling light - directional - with electronic gear - with LED  
driver  
Deckenleuchte - schwenkbar - mit elektronischem  
Vorschaltgerät - mit Driver LED

#### Ref

1499LED.1M

1499LED.14

#### Lamptype

⚡ HIR-CE111 GX8,5 (2) 35W 230V

⚙️ powered 700mA . (2) 3W 700mA

#### Dimensions

↔ L445xB124xH150-215

⤴ L255xB90xH60

build-up

### 954/.. - OPERA

~230V

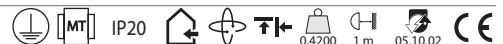

build-up ceiling or wall light - directional - with transformer  
Decken- oder Wandleuchte für Aufbau - schwenkbar - mit  
Trafo

#### Ref

954.1M

954.14

#### Lamptype

⚡ QR-LP111 G53 (1) 50W 12V

or ⚡ PAR 36 screw (1) 50W 12V

#### Dimensions

↔ L170xB177xH90

⤴ L170xB40

build-up  
60VA

### 953/.. - OPERA

~230V



build-up ceiling or wall light - directional - with transformer  
Decken- oder Wandleuchte für Aufbau - schwenkbar - mit  
Trafo

#### Ref

953.1M

953.14

#### Lamptype

⚡ QR-LP111 G53 (2) 50W 12V

or ⚡ PAR 36 screw (2) 50W 12V

#### Dimensions

↔ L310xB177xH90

⤴ L310xB40

build-up  
105VA



955/.. - OPERA

~230V   IP20     2,3300  1 m  05.10.02 





build-up ceiling or wall light - directional - with transformer  
Decken- oder Wandleuchte für Aufbau - schwenkbar - mit Trafo

**Ref**  
955.1M  
955.14

**Lamp type**

 QR-LP111 G53 (3) 50W 12V  
or  PAR 36 screw (3) 50W 12V

**Dimensions**

 L460xB177xH90  
 L460xB40

build-up  
60VA+105VA

956/.. - OPERA



~230V   IP20     1,6000  1 m  05.10.02 





build-up ceiling or wall light - directional - with transformer  
Decken- oder Wandleuchte für Aufbau - schwenkbar - mit Trafo

**Ref**  
956.1M  
956.14

**Lamp type**

 QR-LP111 G53 (4) 50W 12V  
or  PAR 36 screw (4) 50W 12V

**Dimensions**

 L605xB177xH90  
 L605xB40

build-up  
2x105VA

1441/.. - OPERA

~230V   IP20     0,6950  1 m  05.10.50 





build-up ceiling or wall light - directional - with electronic gear  
Decken- oder Wandleuchte für Aufbau - schwenkbar - mit elektronischem Vorschaltgerät

**Ref**  
1441.1M  
1441.14

**Lamp type**

 HIR-CE111 GX8,5 (1) 35W 230V

**Dimensions**

 B170xH120xD290  
 B170xH90

build-up

1461/.. - OPERA

~230V   IP20     0,7300  1 m  05.10.50 





build-up ceiling or wall light - directional - with electronic gear  
Decken- oder Wandleuchte für Aufbau - schwenkbar - mit elektronischem Vorschaltgerät

**Ref**  
1461.1M  
1461.14

**Lamp type**

 HIR-CE111 GX8,5 (1) 70W 230V

**Dimensions**

 B170xH120xD290  
 B170xH90

build-up

1442/.. - OPERA

~230V   IP20     1,2275  1m  05.10.50 



build-up ceiling or wall light - directional - with electronic gear  
Decken- oder Wandleuchte für Aufbau - schwenkbar - mit elektronischem Vorschaltgerät



Ref

1442.1M  
1442.14

Lamptype

 HIR-CE111 GX8,5 (2) 35W 230V

Dimensions

 B315xH120xD290  
 B315xH90

build-up

1462/.. - OPERA

~230V   IP20     1,3090  1m  05.10.50 



build-up ceiling or wall light - directional - with electronic gear  
Decken- oder Wandleuchte für Aufbau - schwenkbar - mit elektronischem Vorschaltgerät



Ref

1462.1M  
1462.14

Lamptype

 HIR-CE111 GX8,5 (2) 70W 230V

Dimensions

 B315xH120xD290  
 B315xH90

build-up

1443/.. - OPERA

~230V   IP20     2,0640  1m  05.10.50 



build-up ceiling or wall light - directional - with electronic gear  
Decken- oder Wandleuchte für Aufbau - schwenkbar - mit elektronischem Vorschaltgerät



Ref

1443.1M  
1443.14

Lamptype

 HIR-CE111 GX8,5 (3) 35W 230V

Dimensions

 B455xH120xD290  
 B455xH90

build-up

1463/.. - OPERA

~230V   IP20     2,1550  1m  05.10.50 



build-up ceiling or wall light - directional - with electronic gear  
Decken- oder Wandleuchte für Aufbau - schwenkbar - mit elektronischem Vorschaltgerät



Ref

1463.1M  
1463.14

Lamptype

 HIR-CE111 GX8,5 (3) 70W 230V

Dimensions

 B455xH120xD290  
 B455xH90

build-up

1444/.. - OPERA

~230V   IP20     2,1650  1 m  05.10.50 



build-up ceiling or wall light - directional - with electronic gear  
Decken- oder Wandleuchte für Aufbau - schwenkbar - mit elektronischem Vorschaltgerät



Ref

1444.1M  
1444.14

Lamptype

 HIR-CE111 GX8,5 (4) 35W 230V

Dimensions

 B605xH120xD290  
 B605xH90

build-up

1464/.. - OPERA

~230V   IP20     2,2625  1 m  05.10.50 



build-up ceiling or wall light - directional - with electronic gear  
Decken- oder Wandleuchte für Aufbau - schwenkbar - mit elektronischem Vorschaltgerät



Ref

1464.1M  
1464.14

Lamptype

 HIR-CE111 GX8,5 (4) 70W 230V

Dimensions

 B605xH120xD290  
 B605xH90

build-up

4040/.. - OPERA HORIZ.

~230V   IP20     1,5 m  1,0325  1 m  05.10.02 



pendant - directional - with transformer  
Pendelleuchte - schwenkbar - mit Trafo



Ref

4040.1M  
4040.14

Lamptype

 QR-LP111 G53 (1) 50W 12V  
or  PAR 36 screw (1) 50W 12V

Dimensions

 L192xB185xH87  
 L110xB80xH35

build-up

60VA - standard with mounting plate  
standard mit Deckenplatte

4041/.. - OPERA VERT.

~230V   IP20     1,5 m  0,8900  1 m  05.10.02 



pendant - directional - with transformer  
Pendelleuchte - schwenkbar - mit Trafo



Ref

4041.1M  
4041.14

Lamptype

 QR-LP111 G53 (1) 50W 12V  
or  PAR 36 screw (1) 50W 12V

Dimensions

 L192xB87xH185  
 L110xB80xH35

build-up

60VA - standard with mounting plate  
standard mit Deckenplatte

4006/.. - OPERA

~230V



pendant - directional - with transformer  
 Pendelleuchte - schwenkbar - mit Trafo

Ref

4006.1M

4006.14

Lamptype

QR-LP111 G53 (2) 50W 12V

or PAR 36 screw (2) 50W 12V

Dimensions

L410xB193xH1500

L105xB65

**build-up**  
 105VA - standard with mounting plate  
 standard mit Deckenplatte

4007/.. - OPERA

~230V

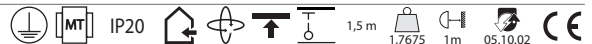

pendant - directional - with transformer  
 Pendelleuchte - schwenkbar - mit Trafo

Ref

4007.1M

4007.14

Lamptype

QR-LP111 G53 (4) 50W 12V

or PAR 36 screw (4) 50W 12V

Dimensions

L410xB304xH1500

L105xB65

**build-up**  
 2x105VA - standard with mounting plate  
 standard mit Deckenplatte

4008/.. - OPERA

~230V

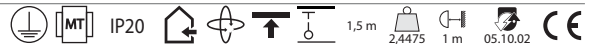

pendant - directional - with transformer  
 Pendelleuchte - schwenkbar - mit Trafo

Ref

4008.1M

4008.14

Lamptype

QR-LP111 G53 (6) 50W 12V

or PAR 36 screw (6) 50W 12V

Dimensions

L410xB536xH1500

L105xB65

**build-up**  
 3x105VA - standard with mounting plate  
 standard mit Deckenplatte

4009/.. - OPERA

~230V



ceiling light - directional - on rod - with transformer  
 Deckenleuchte - schwenkbar - auf Stange - mit Trafo

Ref

4009.1M

4009.14

Lamptype

QR-LP111 G53 (4) 50W 12V

or PAR 36 screw (4) 50W 12V

Dimensions

L410xB364xH545

Ø100

**build-up**  
 2x105VA

1435/.. - OPERA 4 IN LINE

~230V   IP20     1,5 m  2,9025  1 m  05.10.02 



pendant - directional - with transformer  
Pendelleuchte - schwenkbar - mit Trafo

Ref

1435.1M

1435.14

Lamp type

 QR-LP111 G53 (4) 50W 12V

or  PAR 36 screw (4) 50W 12V

Dimensions

 L810xB192xH90

 L385xB105xH20

**build-up**  
2x105VA - standard with mounting plate  
standard mit Deckenplatte

1436/.. - OPERA 4 IN LINE

~230V   IP20     1,5 m  2,2075  1 m  05.10.50 



pendant - directional - with electronic gear  
Pendelleuchte - schwenkbar - mit elektronischem  
Vorschaltgerät

Ref

1436.1M

1436.14

Lamp type

 HIR-CE111 GX8,5 (4) 35W 230V

Dimensions

 L885xB192xH126

 L385xB105xH20

**build-up**  
standard with mounting plate  
standard mit Deckenplatte

1437/.. - OPERA 4 IN LINE

~230V   IP20     1,5 m  3,0910  1 m  05.10.50 



pendant - directional - with electronic gear  
Pendelleuchte - schwenkbar - mit elektronischem  
Vorschaltgerät

Ref

1437.1M

1437.14

Lamp type

 HIR-CE111 GX8,5 (4) 70W 230V

Dimensions

 L885xB192xH126

 L385xB105xH20

**build-up**  
standard with mounting plate  
standard mit Deckenplatte

1438/.. - OPERA 6 IN LINE

~230V   IP20     1,5 m  4,0975  1 m  05.10.02 



pendant - directional - with transformer  
Pendelleuchte - schwenkbar - mit Trafo

Ref

1438.1M

1438.14

Lamp type

 QR-LP111 G53 (6) 50W 12V

or  PAR 36 screw (6) 50W 12V

Dimensions

 L1210xB192xH90

 L760xB106xH20

**build-up**  
3x105VA - standard with mounting plate  
standard mit Deckenplatte

1439/.. - OPERA 6 IN LINE

~230V   IP20       



pendant - directional - with electronic gear  
 Pendelleuchte - schwenkbar - mit elektronischem  
 Vorschaltgerät

**Ref**

1439.1M

1439.14

**Lamptype**

 HIR-CE111 GX8,5 (6) 35W 230V

**Dimensions**

 L1406xB192xH126

 L760xB106xH20

*build-up*  
 standard with mounting plate  
 standard mit Deckenplatte

1440/.. - OPERA 6 IN LINE

~230V   IP20       



pendant - directional - with electronic gear  
 Pendelleuchte - schwenkbar - mit elektronischem  
 Vorschaltgerät

**Ref**

1440.1M

1440.14

**Lamptype**

 HIR-CE111 GX8,5 (6) 70W 230V

**Dimensions**

 L1406xB192xH126

 L760xB106xH20

*build-up*  
 standard with mounting plate  
 standard mit Deckenplatte

4010/.. - OPERA

~230V   IP20    1,900   



build-up wall light - directional - with transformer  
 Wandleuchte für Aufbau - schwenkbar - mit Trafo

**Ref**

4010.1M

4010.14

**Lamptype**

 QR-LP111 G53 (4) 50W 12V

or  PAR 36 screw (4) 50W 12V

**Dimensions**

 B410xH364xD545

 Ø100

*build-up*  
 2x105VA

4011/.. - OPERA

~230V   IP20    2,700   



floorlamp - with switch - cable and plug - with transformer  
 Stehleuchte - mit Schalter - Kabel und Stecker - mit Trafo

**Ref**

4011.1M

4011.14

**Lamptype**

 QR-LP111 G53 (4) 50W 12V

or  PAR 36 screw (4) 50W 12V

**Dimensions**

 L410xB364xH1010

2x105VA

4012/.. - OPERA

~230V   IP20    2,9250  1 m  05.10.02 



floorlamp - with switch - cable and plug - with transformer  
Stehleuchte - mit Schalter - Kabel und Stecker - mit Trafo

Ref

4012.1M

4012.14

Lamptype

 QR-LP111 G53 (4) 50W 12V

or  PAR 36 screw (4) 50W 12V

Dimensions

 L410xB364xH1310

2x105VA

1286/.. - LOBBY

~230V   IP20    0,9300  1 m  05.10.02 



build-up ceiling or wall light - directional - with transformer  
Decken- oder Wandleuchte für Aufbau - schwenkbar - mit Trafo

Ref

1286.14

Lamptype

 QR-LP111 G53 (1) 50W 12V

Dimensions

 Ø115xH275

 Ø70xH8

build-up  
60VA - tube Ø40  
Rohr Ø40

1412/.. - LOBBY

~230V   IP20    1,5100  1 m  05.10.02 



ceiling light - directional - with transformer  
Deckenleuchte - schwenkbar - mit Trafo

Ref

1412.14

Lamptype

 QR-LP111 G53 (2) 50W 12V

Dimensions

 L300xB225xH410

 Ø90xH8

build-up  
105VA - tube Ø40  
Rohr Ø40

1413/.. - LOBBY

~230V   IP20    1,9400  1 m  05.10.02 



ceiling light - directional - with transformer  
Deckenleuchte - schwenkbar - mit Trafo

Ref

1413.14

Lamptype

 QR-LP111 G53 (3) 50W 12V

Dimensions

 L300xB300xH410

 Ø90xH8

build-up  
60VA+105VA - tube Ø40  
Rohr Ø40

1414/.. - LOBBY

~230V   IP20    2,1050  1 m  05.10.02 



ceiling light - directional - with transformer  
Deckenleuchte - schwenkbar - mit Trafo

Ref  
1414.14

Lamptype

 QR-LP111 G53 (4) 50W 12V

Dimensions

 L280xB280xH410

 Ø90xH8

build-up  
2x105VA - tube Ø40  
Rohr Ø40

1415/.. - LOBBY

~230V   IP20    4,1490  0,5 m  05.10.50 



ceiling light - directional - with electronic gear  
Deckenleuchte - schwenkbar - mit elektronischem  
Vorschaltgerät

Ref  
1415.14

Lamptype

 TL16-R 2GX13 (1) 22W 230V

Dimensions

 L370xB370xH450

 Ø90xH8

build-up  
tube Ø40  
Rohr Ø40

1416/.. - LOBBY

~230V   IP20    4,7800  0,5 m  05.10.50 



ceiling light - directional - with electronic gear  
Deckenleuchte - schwenkbar - mit elektronischem  
Vorschaltgerät

Ref  
1416.14

Lamptype

 T16FQ T5 G5 (2) 24W 230V

Dimensions

 L730xB210xH440

 Ø90xH8

build-up  
tube Ø40  
Rohr Ø40

1801/.. - TWIPE

~230V   IP20   0,7217  0,5 m  05.10.50 



ceiling light - with electronic gear  
Deckenleuchte - mit elektronischem Vorschaltgerät

Ref  
1801.1M  
1801.2M  
1801.11M

Lamptype

 TC-TEL GX24Q-3 (1) 32W 230V

Dimensions

 Ø200xH400  40° reflector

 Ø90

build-up  
other °angle reflector on demand  
andere °Winkel Reflektor auf Anfrage  
wall light on request  
Wandleuchte auf Anfrage



1802/.. - TWIPE

~230V [EVG] IP20 2,9800 0,5 m 05.10.50



ceiling light - with electronic gear  
Deckenleuchte - mit elektronischem Vorschaltgerät

Ref

1802.1M  
1802.2M  
1802.11M

Lamptype

TC-TEL GX24Q-3 (2) 32W 230V

Dimensions

L405xB400 40° reflector  
L265xB60

build-up  
other °angle reflector on demand  
andere °Winkel Reflektor auf Anfrage  
wall light on request  
Wandleuchte auf Anfrage

1803/.. - TWIPE PENDANT

~230V [EVG] IP20 1,5 m 1,1000 0,5 m 05.10.50



pendant - with electronic gear  
Pendelleuchte - mit elektronischem Vorschaltgerät

Ref

1803.1M  
1803.2M  
1803.11M

Lamptype

TC-TEL GX24Q-3 (1) 32W 230V

Dimensions

Ø200xH400 40° reflector  
Ø75xH30

build-up  
other °angle reflector on demand  
andere °Winkel Reflektor auf Anfrage



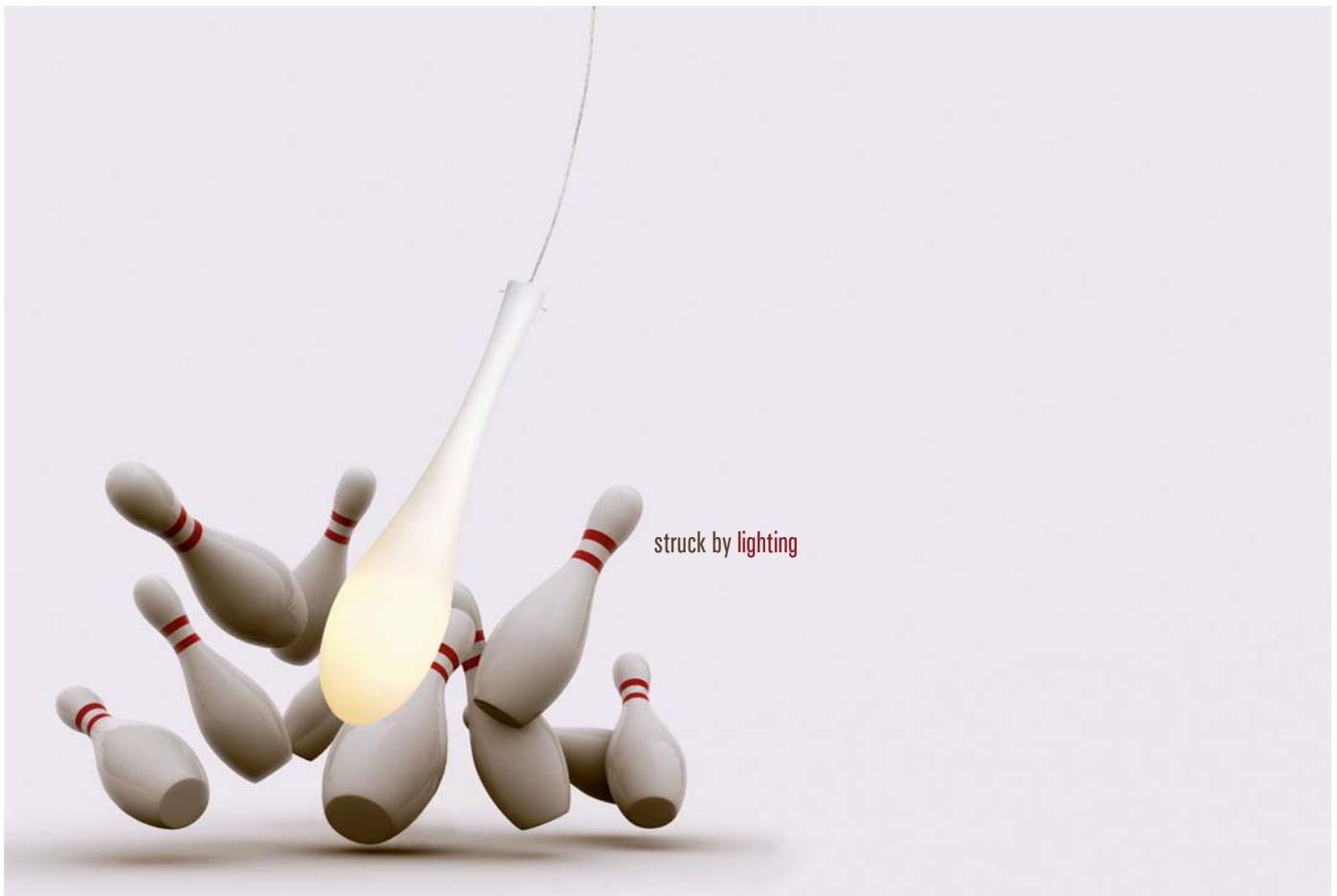

1820/.. - GOTA

~230V  IP20    1,5 m  5,8800  0,5 m  05.10.50 



pendant - with suspension + base - with electronic gear  
 Pendelleuchte - mit Aufhängung + Rosette - mit  
 elektronischem Vorschaltgerät

Ref

1820.14

Lamptype

⇒ T16FHT5 G5 (2) 21W 230V

Dimensions

↔ Ø300xH1220

build-up

1825/.. - GOTA

~230V  IP20    1,5 m  5,6800  0,5 m  05.10.50 



pendant - with suspension + base - with electronic gear  
 Pendelleuchte - mit Aufhängung + Rosette - mit  
 elektronischem Vorschaltgerät

Ref

1825.14

Lamptype

⇐ TC-DEL G24Q2 (1) 18W 230V

⇒ T16FQ T5 G5 (2) 24W 230V

Dimensions

↔ Ø300xH1150 ∟ 40° reflector

build-up

other °angle reflector on demand  
 andere °Winkel Reflektor auf Anfrage



1808/.. - OLIVIA

~12V/=350mA



downlight - without transformer - without LED driver  
Einbaustrahler - ohne Trafo - ohne Driver LED

Ref

- 1808.1M.CW
- 1808.1M.A
- 1808.1M.B

Lamptype

- QR-LP111 G53 (1) 50W 12V
- poweredled 350mA . (1) 1W 350mA

Dimensions

- Ø165xH140
- Ø162 √L 150

Options

- 1808/..B - OLIVIA plasterkit

build-in

1808/..B - OLIVIA plasterkit

IP20

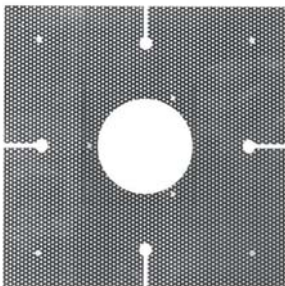

plasterkit  
Einputzrahmen

Ref

- 1808.B

Dimensions

- L350xB350
- Ø162

Options

- 1808/.. - OLIVIA

build-in

1810/.. - OLIVIA

~12V/=350mA III S2 IP20 0,2503 1 m 05.10.02



semi build in/up

semi build-in and build-up ceiling light - without transformer  
- without LED driver  
Halbeinbau und Halbaufbau Deckenleuchte - ohne Trafo -  
ohne Driver LED

**Lamptype**

QR-LP111 G53 (1) 50W 12V  
powered 350mA . (1) 1W 350mA

**Dimensions**

Ø162xH100  
Ø65 50

**Options**

S6.65/.. - PLASTERKIT

**Ref**

- 1810.1M.CW
- 1810.1M.A
- 1810.1M.B
- 1810.2M.CW
- 1810.2M.A
- 1810.2M.B
- 1810.7.A
- 1810.7.B
- 1810.7.CW
- 1810.11M.CW
- 1810.11M.A
- 1810.11M.B
- 1810.14.CW
- 1810.14.A
- 1810.14.B

1840/.. /DISCO - OLIVIA

~12V/=350mA III S1 IP20 0,3833 1 m 05.10.02



build-in

downlight - directional - disco directional spot included -  
without transformer - without LED driver  
Einbaustrahler - schwenkbar - inklusive schwenkbarer Spot  
disco - ohne Trafo - ohne Driver LED

**Lamptype**

QR-CB 51 GU5,3/GX5,3 (1) 50W 12V  
powered 350mA . (1) 1W 350mA

**Dimensions**

Ø110  
Ø100 125

**Options**

1845/.. - OLIVIA  
S6.100/.. - PLASTERKIT

**Ref**

- 1840.1M.CW.DISCO
- 1840.1M.A.DISCO
- 1840.1M.B.DISCO

1840/.. /YOKO - OLIVIA

~12V/=350mA III S1 IP20 0,4100 1 m 05.10.02

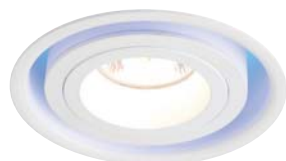

build-in

downlight - fixed - yoko fixed spot included - without  
transformer - without LED driver  
Einbaustrahler - fest - inklusive fester Spot yoko - ohne Trafo  
- ohne Driver LED

**Lamptype**

QR-CB 51 GU5,3/GX5,3 (1) 50W 12V  
powered 350mA . (1) 1W 350mA

**Dimensions**

Ø110  
Ø100 125







**Options**

1845/.. - OLIVIA  
S6.100/.. - PLASTERKIT

**Ref**

- 1840.1M.CW.YOKO
- 1840.1M.A.YOKO
- 1840.1M.B.YOKO

1840../ZUMBA - OLIVIA

~230V   S1 IP20   1 m  



downlight - zumba fixed spot included - without gear  
Einbaustrahler - inklusive fester Spot zumba - ohne  
Vorschaltgerät



Ref

1840.1M.ZUMBA  
1840.11M.ZUMBA

Lamp type

 HIT-TC-CE GU6,5 (1) 35W 230V  
or  HIT-TC-CE GU6,5 (1) 20W 230V

Dimensions

 Ø110  
 Ø100  125

Options

1845../ - OLIVIA  
S6.100../ - PLASTERKIT

**build-in**  
chrome or other colours on request  
Chrom oder andere Farben auf Anfrage

1845../ - OLIVIA

S1 IP20    





build-in base for cassette  
Einbaubasis für Kassette

Ref

1845.1M  
1845.2M  
1845.11M

Dimensions

 L270xB142  
 2xØ100  [130]

Options

1840../DISCO - OLIVIA  
1840../YOKO - OLIVIA  
1840../ZUMBA - OLIVIA  
1845../A - OLIVIA SJABLOON  
1845../B - OLIVIA PLAASTERKIT

**build-in**  
frame to combine with Olivia 1840 (downlight not  
included)  
Frame zu kombinieren mit Olivia 1840 (exklusiv  
Einbaustrahler)

1845../A - OLIVIA SJABLOON

IP20   

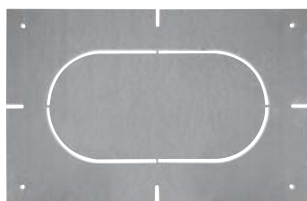

matrix - for 1845  
Matrize - für 1845

Ref

1845.A

Dimensions

 L350xB220

**build-in**

1845../B - OLIVIA PLAASTERKIT

IP20   

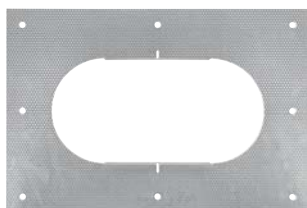



plasterkit - for 1845  
Einputzrahmen - für 1845

Ref

1845.B

Dimensions

 L370xB250  
 260x130

**build-in**

1811/.. - OLIVIA

~230V



ceiling light - with transformer - with LED driver  
Deckenleuchte - mit Trafo - mit Driver LED

**Lamptype**

QR-LP111 G53 (1) 50W 12V  
powered 350mA . (1) 1W 350mA

**Dimensions**

Ø162xH154  
Ø140

**Ref**

- 1811.1M.CW
- 1811.1M.A
- 1811.1M.B
- 1811.2M.7.CW
- 1811.2M.7.A
- 1811.2M.7.B
- 1811.2M.CW
- 1811.2M.A
- 1811.2M.B
- 1811.7.7.CW
- 1811.7.7.A
- 1811.7.7.B
- 1811.11M.CW
- 1811.11M.A
- 1811.11M.B
- 1811.14.CW
- 1811.14.A
- 1811.14.B

build-up

1812/.. - OLIVIA

~230V



ceiling light - with transformer - with LED driver  
Deckenleuchte - mit Trafo - mit Driver LED

**Lamptype**

QR-LP111 G53 (2) 50W 12V  
powered 350mA . (2) 1W 350mA

**Dimensions**

L365xB162xH154  
L280xB80

**Ref**

- 1812.1M.CW
- 1812.1M.A
- 1812.1M.B
- 1812.2M.7.CW
- 1812.2M.7.A
- 1812.2M.7.B
- 1812.2M.CW
- 1812.2M.A
- 1812.2M.B
- 1812.7.7.CW
- 1812.7.7.A
- 1812.7.7.B
- 1812.11M.14.CW
- 1812.11M.14.A
- 1812.11M.14.B
- 1812.11M.CW
- 1812.11M.A
- 1812.11M.B

build-up

1813/.. - OLIVIA

~230V        





ceiling light - with transformer - with LED driver  
Deckenleuchte - mit Trafo - mit Driver LED

**Lamptype**

 QR-LP111 G53 (3) 50W 12V  
 powered 350mA . (3) 1W 350mA

**Dimensions**

 L560xB162xH154  
 L475xB80

**Ref**

- 1813.1M.CW
- 1813.1M.A
- 1813.1M.B
- 1813.2M.7.CW
- 1813.2M.7.A
- 1813.2M.7.B
- 1813.2M.CW
- 1813.2M.A
- 1813.2M.B
- 1813.7.7.CW
- 1813.7.7.A
- 1813.7.7.B
- 1813.11M.14.CW
- 1813.11M.14.A
- 1813.11M.14.B
- 1813.11M.CW
- 1813.11M.A
- 1813.11M.B

build-up

1814/.. - OLIVIA

~230V         





ceiling light - with transformer - with LED driver  
Deckenleuchte - mit Trafo - mit Driver LED

**Lamptype**

 QR-LP111 G53 (4) 50W 12V  
 powered 350mA . (4) 1W 350mA

**Dimensions**

 L760xB162xH154  
 L670xB80

**Ref**

- 1814.1M.CW
- 1814.1M.A
- 1814.1M.B
- 1814.2M.7.CW
- 1814.2M.7.A
- 1814.2M.7.B
- 1814.2M.CW
- 1814.2M.A
- 1814.2M.B
- 1814.7.7.CW
- 1814.7.7.A
- 1814.7.7.B
- 1814.11M.14.CW
- 1814.11M.14.A
- 1814.11M.14.B
- 1814.11M.CW
- 1814.11M.A
- 1814.11M.B

build-up

1815/.. - OLIVIA

~230V



ceiling light - with transformer - with LED driver  
Deckenleuchte - mit Trafo - mit Driver LED

**Lamptype**

QR-LP111 G53 (3) 50W 12V  
powered 350mA . (3) 1W 350mA

**Dimensions**

L370xB370xH154  
L275xB275

**Ref**

1815.1M.CW  
1815.1M.A  
1815.1M.B  
1815.2M.7.CW  
1815.2M.7.A  
1815.2M.7.B  
1815.2M.CW  
1815.2M.A  
1815.2M.B  
1815.7.7.CW  
1815.7.7.A  
1815.7.7.B  
1815.11M.14.CW  
1815.11M.14.A  
1815.11M.14.B  
1815.11M.CW  
1815.11M.A  
1815.11M.B

build-up

1816/.. - OLIVIA

~230V



ceiling light - with transformer - with LED driver  
Deckenleuchte - mit Trafo - mit Driver LED

**Lamptype**

QR-LP111 G53 (4) 50W 12V  
powered 350mA . (4) 1W 350mA

**Dimensions**

L365xB365xH154  
L280xB280

**Ref**

1816.1M.CW  
1816.1M.A  
1816.1M.B  
1816.2M.7.CW  
1816.2M.7.A  
1816.2M.7.B  
1816.2M.CW  
1816.2M.A  
1816.2M.B  
1816.7.7.CW  
1816.7.7.A  
1816.7.7.B  
1816.11M.14.CW  
1816.11M.14.A  
1816.11M.14.B  
1816.11M.CW  
1816.11M.A  
1816.11M.B

build-up



1807.B2/./E27 - OLIVIA PENDEL E27

~230V IP20 1 m 05.10.02



pendant with swivel and build-up base - rod can be shortened  
 Pendelleuchte mit Kugelgelenk und Aufbaurosette - kürzbare Stange

**Lamptype**

TC-HSE E27 (1) 11W 230V

**Dimensions**

Ø162xH140 - Bar 700

Ø54xH60

**Ref**

- 1807.B2.1M.E27
- 1807.B2.7.E27
- 1807.B2.13.E27
- 1807.B2.14.E27
- 1807.B2.17.E27
- 1807.B2.23.E27

build-up  
 other lengths available on request  
 andere Längen auf Anfrage

1807.B3/./E27 - OLIVIA PENDEL E27

~230V IP20 0,0392 1 m 05.10.02



pendant with swivel - rod can be shortened  
 Pendelleuchte mit Kugelgelenk - kürzbare Stange

**Lamptype**

TC-HSE E27 (1) 11W 230V

**Dimensions**

Ø162xH140 - Bar 800

**Ref**

- 1807.B3.1M.E27
- 1807.B3.7.E27
- 1807.B3.13.E27
- 1807.B3.14.E27
- 1807.B3.17.E27
- 1807.B3.23.E27

without base  
 ohne Rosette

1817.B1/./ - OLIVIA PENDEL B1

~230V IP20 0,4300 1 m 05.10.02



pendant with swivel and build-up base - rod can be shortened - with transformer - with LED driver  
 Pendelleuchte mit Kugelgelenk und Aufbaurosette - kürzbare Stange - mit Trafo - mit Driver LED

**Lamptype**

QR-LP111 G53 (1) 50W 12V  
 powered 350mA . (1) 1W 350mA

**Dimensions**

Ø162xH140 - Bar 700

Ø90xH85

**Ref**

- 1817.B1.1M.CW
- 1817.B1.1M.A
- 1817.B1.1M.B
- 1817.B1.2M.7.CW
- 1817.B1.2M.7.A
- 1817.B1.2M.7.B
- 1817.B1.2M.CW
- 1817.B1.2M.A
- 1817.B1.2M.B
- 1817.B1.7.7.CW
- 1817.B1.7.7.A
- 1817.B1.7.7.B
- 1817.B1.11M.14.CW
- 1817.B1.11M.14.A
- 1817.B1.11M.14.B
- 1817.B1.11M.CW
- 1817.B1.11M.A
- 1817.B1.11M.B
- 1817.B1.13.CW
- 1817.B1.13.A
- 1817.B1.13.B
- 1817.B1.14.14.CW
- 1817.B1.14.14.A
- 1817.B1.14.14.B
- 1817.B1.23.CW
- 1817.B1.23.A
- 1817.B1.23.B

build-up

1817.B3/.. - OLIVIA PENDEL B3

~12V/=350mA III   IP20    0.0793  1 m 05.10.02 



pendant with swivel - rod can be shortened - without transformer - without LED driver  
 Pendelleuchte mit Kugelgelenk - kürzbare Stange - ohne Trafo - ohne Driver LED

**Lamptype**

 QR-LP111 G53 (1) 50W 12V  
 poweredled 350mA . (1) 1W 350mA

**Dimensions**

 Ø162xH140 - Bar 800

**Ref**

- 1817.B3.1M.CW
- 1817.B3.1M.A
- 1817.B3.1M.B
- 1817.B3.2M.CW
- 1817.B3.2M.A
- 1817.B3.2M.B
- 1817.B3.7.CW
- 1817.B3.7.A
- 1817.B3.7.B
- 1817.B3.11M.CW
- 1817.B3.11M.A
- 1817.B3.11M.B
- 1817.B3.13.CW
- 1817.B3.13.A
- 1817.B3.13.B
- 1817.B3.14.CW
- 1817.B3.14.A
- 1817.B3.14.B
- 1817.B3.23.CW
- 1817.B3.23.A
- 1817.B3.23.B

without base  
ohne Rosette

1818.B2/.. - OLIVIA PENDEL ES111

~230V  IP20   0.5 m  05.10.02 



pendant with swivel and build-up base - rod can be shortened  
 Pendelleuchte mit Kugelgelenk und Aufbaurosette - kürzbare Stange

**Lamptype**

 QPAR-CB 111 GZ10 (1) 100W 230V

**Dimensions**

 Ø162xH140 - Bar 700

 Ø54xH60

**Ref**

- 1818.B2.1M.1M
- 1818.B2.2M.2M
- 1818.B2.7.7
- 1818.B2.11M.11M
- 1818.B2.14.14

build-up

1819/./DOWN - OLIVIA

~230V     1 m 05.10.02 





build-up wall light - with transformer - with LED driver  
Wandleuchte für Aufbau - mit Trafo - mit Driver LED

**Lamptype**

 QR-LP111 G53 (1) 50W 12V  
 poweredled 350mA . (1) 1W 350mA

**Dimensions**

 Ø162xH154xD200  
 B80xH60

**Ref**

- 1819.1M.CW.DOWN
- 1819.1M.A.DOWN
- 1819.1M.B.DOWN
- 1819.2M.7.CW.DOWN
- 1819.2M.7.A.DOWN
- 1819.2M.7.B.DOWN
- 1819.2M.CW.DOWN
- 1819.2M.A.DOWN
- 1819.2M.B.DOWN
- 1819.7.7.CW.DOWN
- 1819.7.7.A.DOWN
- 1819.7.7.B.DOWN
- 1819.11M.14.CW.DOWN
- 1819.11M.14.A.DOWN
- 1819.11M.14.B.DOWN
- 1819.11M.CW.DOWN
- 1819.11M.A.DOWN
- 1819.11M.B.DOWN

build-up

1819/./UP - OLIVIA

~230V  IP20   0,5 m 05.10.02 





build-up wall light - without LED  
Wandleuchte für Aufbau - ohne LED

**Lamptype**

 QPAR-CB 111 GZ10 (1) 100W 230V

**Dimensions**

 Ø162xH154xD200  
 B80xH60

**Ref**

- 1819.1M.UP
- 1819.2M.UP
- 1819.2M.7.UP
- 1819.7.7.UP
- 1819.11M.UP
- 1819.11M.14.UP

build-up

1911/./E27 - OLIVIA MINI

~230V  IP20   1 m 05.10.02 





ceiling light  
Deckenleuchte

**Lamptype**

 TC-HSE E27 (1) 11W 230V

**Dimensions**

 Ø100xH140  
 Ø60

**Ref**

- 1911.1M.E27
- 1911.7.E27
- 1911.13.E27
- 1911.14.E27
- 1911.17.E27
- 1911.23.E27

build-up

1911../ES50 - OLIVIA MINI

~230V IP20 0,0425 1 m 05.10.02



ceiling light  
Deckenleuchte

**Lamptype**

QPAR 51 GU10 (1) 50W 230V  
or QPAR 51 GU10 (1) 11W 230V

**Dimensions**

Ø100xH140  
Ø60

**Ref**

1911.1M.ES50  
1911.7.ES50  
1911.13.ES50  
1911.14.ES50  
1911.17.ES50  
1911.23.ES50

build-up

1912../E27 - OLIVIA MINI

~230V IP20 0,5008 1 m 05.10.02



ceiling light  
Deckenleuchte

**Lamptype**

TC-HSE E27 (2) 11W 230V

**Dimensions**

L400xB100xH140  
L360xB60

**Ref**

1912.1M.E27  
1912.7.E27  
1912.13.E27  
1912.14.E27  
1912.17.E27  
1912.23.E27

build-up

1912../ES50 - OLIVIA MINI

~230V IP20 1 m 05.10.02



ceiling light  
Deckenleuchte

**Lamptype**

QPAR 51 GU10 (2) 50W 230V  
or QPAR 51 GU10 (2) 11W 230V

**Dimensions**

L400xB100xH140  
L360xB60

**Ref**

1912.1M.ES50  
1912.7.ES50  
1912.13.ES50  
1912.14.ES50  
1912.17.ES50  
1912.23.ES50

build-up

1913../E27 - OLIVIA MINI

~230V IP20 1 m 05.10.02



ceiling light  
Deckenleuchte

**Lamptype**

TC-HSE E27 (3) 11W 230V

**Dimensions**

L600xB100xH140  
L560xB60

**Ref**

1913.1M.E27  
1913.7.E27  
1913.13.E27  
1913.14.E27  
1913.17.E27  
1913.23.E27

build-up

1913../ES50 - OLIVIA MINI

~230V IP20 1 m 05.10.02



ceiling light  
Deckenleuchte

**Lamptype**

QPAR 51 GU10 (3) 50W 230V  
or QPAR 51 GU10 (3) 11W 230V

**Dimensions**

L600xB100xH140  
L560xB60

**Ref**

1913.1M.ES50  
1913.7.ES50  
1913.13.ES50  
1913.14.ES50  
1913.17.ES50  
1913.23.ES50

build-up

1914../E27 - OLIVIA MINI

~230V IP20 1 m 05.10.02



ceiling light  
Deckenleuchte

**Lamptype**

TC-HSE E27 (4) 11W 230V

**Dimensions**

L800xB100xH140  
L760xB60

**Ref**

1914.1M.E27  
1914.7.E27  
1914.13.E27  
1914.14.E27  
1914.17.E27  
1914.23.E27

build-up

1914../ES50 - OLIVIA MINI

~230V IP20 1 m 05.10.02



ceiling light  
Deckenleuchte

**Lamptype**

QPAR 51 GU10 (4) 50W 230V  
or QPAR 51 GU10 (4) 11W 230V

**Dimensions**

L800xB100xH140  
L760xB60

**Ref**

1914.1M.ES50  
1914.7.ES50  
1914.13.ES50  
1914.14.ES50  
1914.17.ES50  
1914.23.ES50

build-up

1915../E27 - OLIVIA MINI

~230V IP20 0,4025 1 m 05.10.02

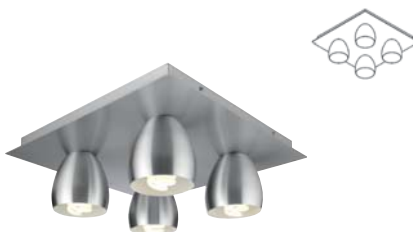

ceiling light  
Deckenleuchte

**Lamptype**

TC-HSE E27 (4) 11W 230V

**Dimensions**

L400xB400xH140  
L360xB360

**Ref**

1915.1M.E27  
1915.7.E27  
1915.13.E27  
1915.14.E27  
1915.17.E27  
1915.23.E27

build-up

1915./../ES50 - OLIVIA MINI

~230V  IP20   1,2117  1 m  05.10.02 

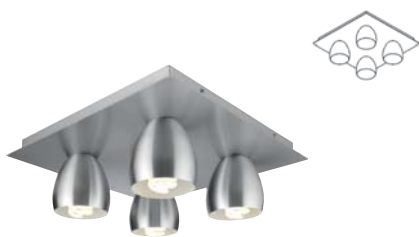

ceiling light  
Deckenleuchte

**Lamptype**

 QPAR 51 GU10 (4) 50W 230V  
or  QPAR 51 GU10 (4) 11W 230V

**Dimensions**

 L400xB400xH140  
 L360xB360

**Ref**

1915.1M.ES50  
1915.7.ES50  
1915.13.ES50  
1915.14.ES50  
1915.17.ES50  
1915.23.ES50

build-up

1918.B2./../E27 - OLIVIA MINI

~230V  IP20   1 m  05.10.02 



pendant with swivel and build-up base - rod can be shortened  
Pendelleuchte mit Kugelgelenk und Aufbaurosette - kürzbare Stange

**Lamptype**

 TC-HSE E27 (1) 11W 230V

**Dimensions**

 Ø100 - Bar 700  
 Ø54xH60

**Ref**

1918.B2.1M.E27  
1918.B2.7.E27  
1918.B2.13.E27  
1918.B2.14.E27  
1918.B2.17.E27  
1918.B2.23.E27

build-up

1918.B2./../ES50 - OLIVIA MINI

~230V  IP20   1 m  05.10.02 



pendant with swivel and build-up base - rod can be shortened  
Pendelleuchte mit Kugelgelenk und Aufbaurosette - kürzbare Stange

**Lamptype**

 QPAR 51 GU10 (1) 50W 230V  
or  QPAR 51 GU10 (1) 11W 230V

**Dimensions**

 Ø100 - Bar 700  
 Ø54xH60

**Ref**

1918.B2.1M.ES50  
1918.B2.7.ES50  
1918.B2.13.ES50  
1918.B2.14.ES50  
1918.B2.17.ES50  
1918.B2.23.ES50

build-up

1918.B3./../E27 - OLIVIA MINI

~230V  IP20   1 m  05.10.02 



pendant with swivel - rod can be shortened  
Pendelleuchte mit Kugelgelenk - kürzbare Stange

**Lamptype**

 TC-HSE E27 (1) 11W 230V

**Dimensions**

 Ø100 - Bar 800

**Ref**

1918.B3.1M.E27  
1918.B3.7.E27  
1918.B3.13.E27  
1918.B3.14.E27  
1918.B3.17.E27  
1918.B3.23.E27

1918.B3/./ES50 - OLIVIA MINI

~230V IP20 1 m 05.10.02



build-up

pendant with swivel - rod can be shortened  
 Pendelleuchte mit Kugelgelenk - kürzbare Stange

**Lamp type**

QPAR 51 GU10 (1) 50W 230V  
 or QPAR 51 GU10 (1) 11W 230V

**Dimensions**

Ø100 - Bar 800

**Ref**

- 1918.B3.1M.ES50
- 1918.B3.7.ES50
- 1918.B3.13.ES50
- 1918.B3.14.ES50
- 1918.B3.17.ES50
- 1918.B3.23.ES50

1919/./E27 - OLIVIA MINI

~230V IP20 0,9433 1 m 05.10.02



build-up

pendant with swivel - rod can be shortened  
 Pendelleuchte mit Kugelgelenk - kürzbare Stange

**Lamp type**

TC-HSE E27 (3) 11W 230V

**Dimensions**

L900xB110xH760

L430xB60xH30

**Ref**

- 1919.1M.E27
- 1919.7.E27
- 1919.13.E27
- 1919.14.E27
- 1919.17.E27
- 1919.23.E27

1919/./ES50 - OLIVIA MINI

~230V IP20 1 m 05.10.02



build-up

pendant with swivel - rod can be shortened  
 Pendelleuchte mit Kugelgelenk - kürzbare Stange

**Lamp type**

QPAR 51 GU10 (3) 50W 230V  
 or QPAR 51 GU10 (3) 11W 230V

**Dimensions**

L900xB110xH760

L430xB60xH30

**Ref**

- 1919.1M.ES50
- 1919.7.ES50
- 1919.13.ES50
- 1919.14.ES50
- 1919.17.ES50
- 1919.23.ES50

1920/./E27 - OLIVIA MINI UP

~230V IP20 1 m 05.10.02

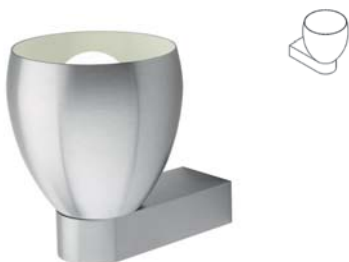

build-up

build-up wall light  
 Wandleuchte für Aufbau

**Lamp type**

TC-HSE E27 (1) 11W 230V

**Dimensions**

Ø100xH145xD135

B50xH30

**Ref**

- 1920.1M.E27
- 1920.7.E27
- 1920.13.E27
- 1920.14.E27
- 1920.17.E27
- 1920.23.E27

1920../ES50 - OLIVIA MINI UP

~230V IP20 0,1533 1 m 05.10.02



build-up wall light  
Wandleuchte für Aufbau

Ref

Lamptype

QPAR 51 GU10 (1) 50W 230V  
or QPAR 51 GU10 (1) 11W 230V

1920.1M.ES50  
1920.7.ES50  
1920.13.ES50  
1920.14.ES50  
1920.17.ES50  
1920.23.ES50

Dimensions

Ø100xH145xD135  
B50xH30

build-up

1921../E27 - OLIVIA MINI DOWN

~230V IP20 0,1533 1 m 05.10.02



build-up wall light  
Wandleuchte für Aufbau

Ref

Lamptype

TC-HSE E27 (1) 11W 230V

1921.1M.E27  
1921.7.E27  
1921.13.E27  
1921.14.E27  
1921.17.E27  
1921.23.E27

Dimensions

Ø100xH145xD135  
B50xH30

build-up

1921../ES50 - OLIVIA MINI DOWN

~230V IP20 0,1533 1 m 05.10.02



build-up wall light  
Wandleuchte für Aufbau

Ref

Lamptype

QPAR 51 GU10 (1) 50W 230V  
or QPAR 51 GU10 (1) 11W 230V

1921.1M.ES50  
1921.7.ES50  
1921.13.ES50  
1921.14.ES50  
1921.17.ES50  
1921.23.ES50

Dimensions

Ø100xH145xD135  
B50xH30

build-up

1470../ - BAMBU

~230V IP20 1,5 m 1,4700 1 m 05.10.02



pendant  
Pendelleuchte

Ref

Lamptype

QPAR 51 GU10 (1) 50W 230V  
led 230V .(1) 2W 230V

1470.CW.7  
1470.CW.14  
1470.B.7  
1470.B.14  
1470.GR.7  
1470.GR.14

Dimensions

Ø100xH240  
Ø100xH32

build-up



1473/.. - BAMBU

~230V  IP20    0,5 m  



build-up wall light  
Wandleuchte für Aufbau

Ref

1473.7

Lamptype

 D45 E14 (1) 40W 230V

1473.14

Dimensions

 Ø100xH285xD125

 Ø70

build-up

1454/.. - AMBON

~230V   IP20     1 m  



build-up ceiling or wall light - directional - with electronic gear  
Decken- oder Wandleuchte für Aufbau - schwenkbar - mit elektronischem Vorschaltgerät

Ref

1454.14

Lamptype

 HIPAR51 GX10 (1) 35W 230V

Dimensions

 L145xB130xH90

 Ø60

build-up  
available for track system on request  
verfügbar für Schienensystem auf Anfrage

1950/.. - FLASH

~230V   IP20    1 m  



ceiling light - with transformer  
Deckenleuchte - mit Trafo

Ref

1950.1M

Lamptype

 QR-LP111 G53 (1) 50W 12V

1950.2M.11M

Dimensions

 L190xB200xH235

1950.11M

 Ø51,5

build-up

1951/.. - FLASH

~230V   IP20    1 m  



ceiling light for track - without adaptor - with electronic gear  
Deckenleuchte für Schienensystem - ohne Adapter - mit elektronischem Vorschaltgerät

Ref

1951.1M

Lamptype

 HIR-CE111 GX8,5 (1) 35W 230V

1951.2M.11M

Dimensions

 L190xB200

1951.11M

build-up

1952.M10/.. - FLASH M10 - M10

~12V



build-up spot M10 - without transformer  
Aufbaustrahler M10 - ohne Trafo

**Lamp type**

QR-LP111 G53 (1) 50W 12V

**Dimensions**

Ø120xH180 - Bar 100

**Ref**

1952.M10.1M  
1952.M10.2M.11M  
1952.M10.11M

*build-up*  
to combine with adaptor or profile  
zu kombinieren mit einem Adapter oder Profil

1952.M13/.. - FLASH M13

~230V



build-up spot M13 - without gear  
Aufbaustrahler M13 - ohne Vorschaltgerät

**Lamp type**

HIR-CE111 GX8,5 (1) 35W 230V  
or HIR-CE111 GX8,5 (1) 70W 230V

**Dimensions**

Ø120xH180 - Bar 100

**Ref**

1952.M13.1M  
1952.M13.2M.11M  
1952.M13.11M

*build-up*  
to combine with adaptor or profile  
zu kombinieren mit einem Adapter oder Profil

1956/.. - VOLTA 12V - M10

~12V



build-up spot M10 - without rod - without transformer  
Aufbaustrahler M10 - ohne Stange - ohne Trafo

**Lamp type**

QR-LP70 BA15d (1) 50W 12V

**Dimensions**

Ø78,5xL120

**Ref**

1956.1M  
1956.7  
1956.10  
1956.13  
1956.14  
1956.23

*build-up*



chrome or other colours on request  
 Chrom oder andere Farben auf Anfrage

**1841../.. - ZUMBA** ~230V   S1 IP20   1m 05.10.50 





ceiling light - without gear  
 Deckenleuchte - ohne Vorschaltgerät

**Lamp type**

 HIT-TC-CE G8,5 (1) 35W 230V  
 or  HIT-TC-CE G8,5 (1) 70W 230V

**Dimensions**

 Ø155xH120  
 Ø140  150

**Ref**

1841.1M  
 1841.11M

build-in

**1955A.M13../.. - ZUMBA** ~230V   IP20   1m 05.10.50 





build-up spot M13 - for track system - without adaptor -  
 M13x1 connection adaptor (for Philips lamp PGJ5 on request)  
 - without gear  
 Aufbaustrahler M13 - für Schienensystem - ohne Adapter  
 - M13x1 Anschluß Adapter (für Philips Lampe PGJ5 auf  
 Anfrage) - ohne Vorschaltgerät

**Lamp type**

 HIT-TC-CE G8,5 (1) 70W 230V

**Dimensions**

 Ø140xH270  40° reflector - Bar 100  
 3mm glass - Glas

**Ref**

1955A.M13.1M  
 1955A.M13.11M



build-up

**1955B.M13../.. - ZUMBA - M13** ~230V   IP20   1m 05.10.50 





build-up spot M13 - for track system - without adaptor -  
 M13x1 connection adaptor (for Philips lamp PGJ5 on request)  
 - without gear  
 Aufbaustrahler M13 - für Schienensystem - ohne Adapter  
 - M13x1 Anschluß Adapter (für Philips Lampe PGJ5 auf  
 Anfrage) - ohne Vorschaltgerät

**Lamp type**

 HIT-TC-CE GU6,5 (1) 35W 230V  
 or  HIT-TC-CE GU6,5 (1) 20W 230V

**Dimensions**

 Ø100xH180  40° reflector - Bar 100  
 3mm glass - Glas

**Ref**

1955B.M13.1M  
 1955B.M13.11M

build-up

**1953.A../.. - ZUMBA** ~230V   IP20   1m 05.10.50 







ceiling light - with electronic gear  
 Deckenleuchte - mit elektronischem Vorschaltgerät

**Lamp type**

 HIT-TC-CE G8,5 (1) 70W 230V

**Dimensions**

 L237xB98xH232  40° reflector  
 L237xB98  
 3mm glass - Glas

**Ref**

1953.A.1M  
 1953.A.11M

build-up

Architectural lighting indoor

# INDOOR | Architectural | ZUMBA | ADAPTOR

chrome or other colours on request  
 Chrom oder andere Farben auf Anfrage

## 1953.B/.. - ZUMBA

~230V



ceiling light - with electronic gear  
 Deckenleuchte - mit elektronischem Vorschaltgerät

Ref

1953.B.1M

### Lamptype

HIT-TC-CE G8,5 (2) 70W 230V

1953.B.11M

### Dimensions

L407xB98xH232  $\wedge$  40° reflector

L407xB98

3mm glass - Glas

build-up

## 1954.A/.. - ZUMBA

~230V



ceiling light - with electronic gear  
 Deckenleuchte - mit elektronischem Vorschaltgerät

Ref

1954.A.1M

### Lamptype

HIT-TC-CE GU6,5 (1) 35W 230V

1954.A.11M

or HIT-TC-CE GU6,5 (1) 20W 230V

### Dimensions

L237xB98xH232  $\wedge$  40° reflector

L237xB98

3mm glass - Glas

build-up

## 1954.B/.. - ZUMBA

~230V



ceiling light - with electronic gear  
 Deckenleuchte - mit elektronischem Vorschaltgerät

Ref

1954.B.1M

### Lamptype

HIT-TC-CE GU6,5 (2) 35W 230V

1954.B.11M

or HIT-TC-CE GU6,5 (2) 20W 230V

### Dimensions

L407xB98xH232  $\wedge$  40° reflector

L407xB98

3mm glass - Glas

build-up

## 1455.M10/.. - ADAPTOR - M10

~230V



supplement - universal 3-phase adapter with M10 nipple  
 Supplement - 3-Phasen-Adapter mit Nippel M10

Ref

1455.M10.1

1455.M10.11

build-up  
 230V

1456.M10/.. - ADAPTOR - M10

~230V   IP20   

supplement - universal 3-phase adapter with M10 nipple - with transformer  
 Supplement - 3-Phasen-Adapter mit Nippel M10 - mit Trafo

Ref  
 1456.M10.1  
 1456.M10.11



build-up  
 12V

1457.M13/.. - ADAPTOR - M13

~230V   IP20   

supplement - universal 3-phase adapter with M13 nipple - with electronic gear  
 Supplement - 3-Phasen-Adapter mit Nippel M13 - mit elektronischem Vorschaltgerät

Ref  
 1457.M13.1  
 1457.M13.11



build-up  
 20W discharge lamp  
 Entladungslampe

1458.M13/.. - ADAPTOR - M13

~230V   IP20   

supplement - universal 3-phase adapter with M13 nipple - with electronic gear  
 Supplement - 3-Phasen-Adapter mit Nippel M13 - mit elektronischem Vorschaltgerät

Ref  
 1458.M13.1  
 1458.M13.11



build-up  
 35W discharge lamp  
 Entladungslampe

1459.M13/.. - ADAPTOR - M13

~230V   IP20   

supplement - universal 3-phase adapter with M13 nipple - with electronic gear  
 Supplement - 3-Phasen-Adapter mit Nippel M13 - mit elektronischem Vorschaltgerät

Ref  
 1459.M13.1  
 1459.M13.11



build-up  
 70W discharge lamp  
 Entladungslampe



**INDOOR | Table - & Floorlamps**

**ATOMIS**

3038/.. P.299



**TURNER**

3037/.. P.299



**VOLTA**

1958/.. P.299



**ORKA**

3020/.. P.300



**CUBIC**

978/..T P.300



**CUBIC LED**

979LED/..T P.300



**BETA**

1741/.. P.300



1742/.. P.301



1743/.. P.301



**TOTEM**

988/.. P.302



989/.. P.302



**BOOSTER**

905/.. P.301



**GOCCI**

3072/.. P.302



**SPAZIO**

3070/.. P.302



**VOGUE**

990/.. P.301



**OPERA**

4011/.. P.303



**MONTE CRISTO**

4012/.. P.303



4030/.. P.303



**WING**

1542/.. P.306



1540/.. P.308



1541/.. P.308



**GOTA**

1830/.. P.308



1831/.. P.308



1832/.. P.309



ATOMIS	299
BETAPLUS	300, 301
BOOSTER	301
CUBIC	300
GOCCI	302
GOTA	308, 309
MONTE CRISTO	303
OPERA	303
ORKA TABLE	300
SPAZIO	302
TOTEM	302
TOTEM MINI	302
TURNER	299
VOGUE	304, 305, 306
VOLTA	299
WING	306, 307
WING TABLE & FLOOR LAMP	308

3037/.. - TURNER

~230V   IP20    0,6400  0,5 m  



table lamp - with switch - cable and plug - with transformer  
Tischleuchte - mit Schalter - Kabel und Stecker - mit Trafo

Ref

3037.14

Lamp type

⊲ QR-CB 51 GU5,3/GX5,3 (1) 50W 12V

3037.16

Dimensions

↔ Ø80xH130

60VA

3038/.. - ATOMIS

~230V   IP20    0,1480  0,5 m  



table lamp - with switch - cable and plug - with transformer  
Tischleuchte - mit Schalter - Kabel und Stecker - mit Trafo

Ref

3038.4

Lamp type

⊲ QR-CB 51 GU5,3/GX5,3 (1) 50W 12V

3038.7

3038.13

Dimensions

↔ L145xB92xH190

3038.14

3038.16

60VA - with dimmer  
mit Dimmer

1958/.. - VOLTA

~230V   IP20    05.10.02 



table lamp - with switch - cable and plug - with transformer  
Tischleuchte - mit Schalter - Kabel und Stecker - mit Trafo

Ref

1958.1M

Lamp type

⊲ QR-LP70 BA15d (1) 50W 12V

1958.7

1958.10

Dimensions

↔ L110xB80xH150

1958.13

1958.14

1958.23

60VA

## INDOOR | Table - & Floorlamps | ORKA TABLE | CUBIC | BETAPLUS

LED colours: cold white (CW) or warm white (WW) - other LED colours on request

LED Farben: kalt Weiß (CW) oder warm Weiß (WW) - andere LED Farben auf Anfrage

### 3020/.. - ORKA TABLE

~230V



table lamp - with switch - cable and plug - with LED driver  
Tischleuchte - mit Schalter - Kabel und Stecker - mit Driver LED

#### Lamptype

⚙️ powered 700mA . (1) 3W 700mA

#### Dimensions

↔️ L110xB80xH40 ∠ 40° reflector

🔧 L90xB65

#### Ref

3020.7.CW  
3020.7.WW  
3020.10.CW  
3020.10.WW  
3020.14.CW  
3020.14.WW  
3020.22.CW  
3020.22.WW  
3020.23.CW  
3020.23.WW

other °angle reflector on demand  
andere °Winkel Reflektor auf Anfrage

### 978/..T - CUBIC

~230V



table lamp - with switch - cable and plug - with transformer  
Tischleuchte - mit Schalter - Kabel und Stecker - mit Trafo

#### Lamptype

🔊 QR-CB 51 GU5,3/GX5,3 (1) 50W 12V

#### Dimensions

↔️ L60xB60xH180

#### Ref

978.14.T

60VA

### 979LED/..T - CUBIC

~230V



table lamp - with switch - cable and plug - with LED driver  
Tischleuchte - mit Schalter - Kabel und Stecker - mit Driver LED

#### Lamptype

⚙️ powered 700mA . (1) 3W 700mA

#### Dimensions

↔️ H107 ∠ 40° reflector

🔧 L60xB60

#### Ref

979LED.14.CW.T  
979LED.14.WW.T

other °angle reflector on demand  
andere °Winkel Reflektor auf Anfrage

### 1741/.. - BETAPLUS

~230V



table lamp - directional - with switch - cable and plug - with transformer  
Tischleuchte - schwenkbar - mit Schalter - Kabel und Stecker - mit Trafo

#### Lamptype

🔊 QR-CB 51 GU5,3/GX5,3 (1) 50W 12V

#### Dimensions

↔️ L90xB90xH145

🔧 L90xB90

#### Ref

1741.1M  
1741.2M  
1741.7  
1741.11M

60VA



1742/.. - BETAPLUS

~230V   IP20     0.5 m  



table lamp - directional - with switch - cable and plug - with transformer  
Tischleuchte - schwenkbar - mit Schalter - Kabel und Stecker - mit Trafo

**Ref**  
1742.1M  
1742.2M  
1742.11M

**Lamp type**

◀ QR-CB 51 GU5,3/GX5,3 (2) 50W 12V

**Dimensions**

↔ L90xB90xH386

↖ L90xB90

105VA

1743/.. - BETAPLUS

~230V   IP20     0.51  



table lamp - directional - with switch - cable and plug - with transformer  
Tischleuchte - schwenkbar - mit Schalter - Kabel und Stecker - mit Trafo

**Ref**  
1743.1M  
1743.2M  
1743.11M

**Lamp type**

◀ QR-CB 51 GU5,3/GX5,3 (3) 50W 12V

**Dimensions**

↔ L90xB90xH457

↖ L90xB90

60VA + 105VA

905/.. - BOOSTER

~230V   IP20    0.51  



table lamp - with electronic gear  
Tischleuchte - mit elektronischem Vorschaltgerät

**Ref**  
905.10  
905.14

**Lamp type**

◀ HIPAR-L30 E27Hs (1) 35W 230V

**Dimensions**

↔ Ø165xH385

905/.. / PAR30 - BOOSTER

~230V  IP20    1 m  



table lamp  
Tischleuchte

**Ref**  
905.10.PAR30

**Lamp type**

◀ QPAR 30 E27 (1) 75W 230V

**Dimensions**

↔ Ø165xH385

988/.. - TOTEM MINI

~230V



table lamp - with switch - cable and plug  
Tischleuchte - mit Schalter - Kabel und Stecker

Ref

988.14

Lamptype

⦿ D45 E14 (1) 40W 230V

Dimensions

↔ L120xB120xH190

989/.. - TOTEM

~230V



table lamp - with switch - cable and plug  
Tischleuchte - mit Schalter - Kabel und Stecker

Ref

989.14

Lamptype

⦿ D45 E14 (1) 60W 230V

Dimensions

↔ L150xB150xH685

3072/.. - GOCCI

~230V



table lamp - directional - with switch - cable and plug  
Tischleuchte - schwenkbar - mit Schalter - Kabel und Stecker

Ref

3072.14

Lamptype

⦿ QPAR 51 GU10 (1) 35W 230V

Dimensions

↔ L230xB70xH230

3070/.. - SPAZIO

~230V



table lamp - with switch - cable and plug  
Tischleuchte - mit Schalter - Kabel und Stecker

Ref

3070.14

Lamptype

⦿ QT14 G9 (1) 40W 230V

or ⦿ CFL G9 (1) 7W 230V

Dimensions

↔ Ø360xH440

4030/.. - MONTE CRISTO

~230V   IP20    6,9600 0,5 m 05.10.02 



floorlamp - directional - with switch - cable and plug - with transformer  
Stehleuchte - schwenkbar - mit Schalter - Kabel und Stecker - mit Trafo

Ref  
4030.14

**Lamptype**

QR-CB 51 GU5,3/GX5,3 (6) 50W 12V

**Dimensions**

H1800

3X105VA

4031/.. - MONTE CRISTO

~230V   IP20    7,2400 0,5 m 05.10.02 



floorlamp - directional - with switch - cable and plug - with transformer  
Stehleuchte - schwenkbar - mit Schalter - Kabel und Stecker - mit Trafo

Ref  
4031.14

**Lamptype**

QR-CB 51 GU5,3/GX5,3 (6) 50W 12V

**Dimensions**

H2100

3X105VA

4011/.. - OPERA

~230V   IP20    2,7000 1 m 05.10.02 



floorlamp - with switch - cable and plug - with transformer  
Stehleuchte - mit Schalter - Kabel und Stecker - mit Trafo

Ref  
4011.1M  
4011.14

**Lamptype**

QR-LP111 G53 (4) 50W 12V  
or PAR 36 screw (4) 50W 12V

**Dimensions**

L410xB364xH1010

2x105VA

4012/.. - OPERA

~230V   IP20    2,9250 1 m 05.10.02 



floorlamp - with switch - cable and plug - with transformer  
Stehleuchte - mit Schalter - Kabel und Stecker - mit Trafo

Ref  
4012.1M  
4012.14

**Lamptype**

QR-LP111 G53 (4) 50W 12V  
or PAR 36 screw (4) 50W 12V

**Dimensions**

L410xB364xH1310

2x105VA

990/././.. - VOGUE

~230V  IP20    0.5 m  05.10.02 



table lamp - without lampshade - with switch + cable  
Tischleuchte - ohne Lampenschirm - mit Schalter + Kabel

**Lamp type**  
◉ D45 E27 (1) 40W 230V

**Dimensions**  
↔ Ø145xH10

Colour	990/././250	990/././300	990/././400
	H 250	H 300	H 400
	14		

MAX.40W - other lengths on demand  
andere Längen auf Anfrage

990A/././.. - VOGUE

~230V  IP20    0.5 m  05.10.02 

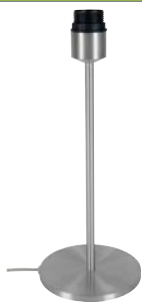

table lamp - without lampshade - with switch + cable  
Tischleuchte - ohne Lampenschirm - mit Schalter + Kabel

**Lamp type**  
◉ D45 E27 (1) 40W 230V

**Dimensions**  
↔ Ø170xH12

Colour	990A/././250	990A/././300	990A/././400
	H 250	H 300	H 400
	7.11		
	13.2		
	14.11		
	23.2		

MAX.40W - socle black or grey - other lengths on demand  
Sockel Schwarz oder Grau - andere Längen auf Anfrage

990B/././.. - VOGUE

~230V  IP20    0.5 m  05.10.02 



table lamp - without lampshade - with switch + cable  
Tischleuchte - ohne Lampenschirm - mit Schalter + Kabel

**Lamp type**  
◉ D45 E27 (1) 40W 230V

**Dimensions**  
↔ L300xB110xH10

Colour	990B/././250	990B/././300	990B/././400
	H 250	H 300	H 400
	14		

MAX.40W - other lengths on demand  
andere Längen auf Anfrage

999/././.. - VOGUE

~230V



IP20



0.0500

0.5 m

05.10.02

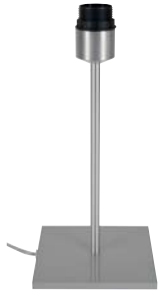

table lamp - without lampshade - with switch + cable  
Tischleuchte - ohne Lampenschirm - mit Schalter + Kabel

Lamp type

◐ D45 E27 (1) 40W 230V

Dimensions

↔ L150xB150xH10

Colour	999/././250	999/././300	999/././400
	H 250	H 300	H 400
	14		

MAX.40W - other lengths on demand  
andere Längen auf Anfrage

999A/././.. - VOGUE

~230V



IP20



0.5 m

05.10.02

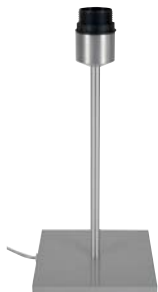

table lamp - without lampshade - with switch + cable  
Tischleuchte - ohne Lampenschirm - mit Schalter + Kabel

Lamp type

◐ D45 E27 (1) 40W 230V

Dimensions

↔ L100xB100xH12

Colour	999A/././250	999A/././300	999A/././400
	H 250	H 300	H 400
	7.11		
	13.2		
	14.11		
	23.2		

MAX.40W - socle black or grey - other lengths on demand  
Sockel Schwarz oder Grau - andere Längen auf Anfrage

999B/./... - VOGUE

~230V  IP20    0.5 m  05.10.02 



table lamp - without lampshade - with switch + cable  
Tischleuchte - ohne Lampenschirm - mit Schalter + Kabel

**Lamp type**

◀ D45 E27 (1) 40W 230V

**Dimensions**

↔ L 170xB170xH12

Colour	999B/./250	999B/./300	999B/./400
	H 250	H 300	H 400
	7.11		
	13.2		
	14.11		
	23.2		

MAX.40W - socle black or grey - other lengths on demand  
Sockel Schwarz oder Grau - andere Längen auf Anfrage

999C/./... - VOGUE

~230V  IP20   0,0500  0.5 m  05.10.02 



table lamp - without lampshade - with switch + cable  
Tischleuchte - ohne Lampenschirm - mit Schalter + Kabel

**Lamp type**

◀ D45 E27 (1) 40W 230V

**Dimensions**

↔ L 80xB80xH10

Colour	999C/./250	999C/./300	999C/./400
	H 250	H 300	H 400
	14		

MAX.40W - other lengths on demand  
andere Längen auf Anfrage

1542/.. - WING

~230V  IP20    0.5 m  05.10.02 



table lamp - lampshade included - with switch + cable  
Tischleuchte - mit Lampenschirm - mit Schalter + Kabel

**Lamp type**

◀ mini lynx longlife E27 (1) 11W 230V

**Dimensions**

↔ L 300xB110xH280

**Ref**

1542.1M.90  
1542.1M.92  
1542.14.90  
1542.14.92

90 = brown / 92 = red  
90 = Braun / 92 = Rot

1542.A/.. - WING

~230V IP20 0.5 m 05.10.02



table lamp - only base with lampholder - with switch + cable  
Tischleuchte - nur Fuß mit Lampenfassung - mit Schalter + Kabel

Ref

1542.A.1M  
1542.A.14

Lamp type

mini lynx longlife E27 (1) 11W 230V

Dimensions

L300xB110xH10

1542.B/.. - WING

IP20 0.5 m



lampshade - 90 = brown 92 = red  
Lampenschirm - 90 = Braun 92 = Rot

Ref

1542.B.90  
1542.B.92

Dimensions

L310xB115xH240

1543/... - WING

~230V IP20 0.5 m 05.10.02



table lamp - without lampshade - with switch + cable  
Tischleuchte - ohne Lampenschirm - mit Schalter + Kabel

Lamp type

mini lynx longlife E27 (1) 11W 230V

Dimensions

L320xB130xH12

Colour	1543/.../250	1543/.../300	1543/.../400
	H 250	H 300	H 400
7.11			
13.2			
14.11			
23.2			

socle black or grey - other lengths on demand  
Sockel Schwarz oder Grau - andere Längen auf Anfrage

1540/.. - WING TABLE LAMP

~230V



table lamp - with switch - cable and plug - with magnetic gear  
Tischleuchte - mit Schalter - Kabel und Stecker - mit magnetischem Vorschaltgerät

Ref

1540.1M

1540.14

Lamptype

← TC-S G23 (1) 11W 230V

Dimensions

↔ L300xB110xH600

1541/.. - WING FLOOR LAMP

~230V



floorlamp - with switch - cable and plug - with electronic gear  
Stehleuchte - mit Schalter - Kabel und Stecker - mit elektronischem Vorschaltgerät

Ref

1541.1M

1541.14

1541.36

Lamptype

⇒ T16FHT5 G5 (2) 35W 230V

Dimensions

↔ L300xB110xH1800

1830/.. - GOTA

~230V



floorlamp - with switch - cable and plug - with electronic gear  
Stehleuchte - mit Schalter - Kabel und Stecker - mit elektronischem Vorschaltgerät

Ref

1830.14

Lamptype

⇒ T16FHT5 G5 (2) 21W 230V

Dimensions

↔ Ø320xH1300

with alu base Ø250mm  
mit Alu Fuß Ø250mm

1831/.. - GOTA

~230V



floorlamp - with switch - cable and plug - with electronic gear  
Stehleuchte - mit Schalter - Kabel und Stecker - mit elektronischem Vorschaltgerät

Ref

1831.14

Lamptype

⇒ T16FHT5 G5 (2) 21W 230V

Dimensions

↔ Ø320xH1900

with alu base Ø350mm  
mit Alu Fuß



1832/.. - GOTA

~230V



floorlamp - with switch - cable and plug - with electronic gear  
 Stehleuchte - mit Schalter - Kabel und Stecker - mit  
 elektronischem Vorschaltgerät

Ref

1832.14

**Lamptype**

⇒ T16FHT5 G5 (2) 21W 230V

**Dimensions**

⇔ Ø320xH1460

with alu base Ø320mm  
 mit Alu Fuß

Table & floorlamps indoor



# INDOOR | Wall lights to build in

## CALIX

1295A/.. P.312



1295D/.. P.312



## COMPACT

1232A/.. P.313



## SCREEN

1235A/.. P.316



## SMALL SCREEN

1238B/.. P.318



## RECTO SCREEN

1238C/.. P.319



## LIMA

1298A/.. P.319



## LOTUS

1404/.. P.320



## MEZZO

1296W/.. P.322



## MIKA

1299/.. P.323



## MIRO

1230A/.. P.324



## SUN

1240/.. P.330



## MOON

1244/.. P.327



1246/..GLASS P.328



1248/.. P.329



## WALL LIGHTS TO BUILD IN

CALIX	312, 313
COMPACT	313, 314, 315
LIMA	319, 320
LOTUS IN	320, 321
MEZZO - MEZZO GRANDE	322, 323
MIKA	323
MIKA GRANDE	324
MIRO	324, 325, 326
MOON - MOON + GLASS	329
RECTO SCREEN	319
SCREEN	316, 317
SINGLE MOON	327
SMALL SCREEN	318
SUN	330, 331
SUN + GLASS	330
SUNGLASS	331, 332
TRIPLE MOON	328
TRIPLE MOON + GLASS	328

## WALL LIGHTS TO BUILD UP

ARC	335
ARCADE	334
AURA	334
AZUR	334
BETAPLUS	335, 336, 337
CANARIA	339
CANVAS A / B	338
CLUB	339
COMMA	340, 341

## WALL LIGHTS TO BUILD UP

DISPLAY	341, 342, 343
FLATFACE	343
FORUM	344
GENIO	343
GOYA	344
GRAN CANARIA	339
GUILIA	344, 345
HAVANA	346, 347
KOBUS	348
LARA	348
LOFT	348
LOLA	349
LOTUS UP	349
LUCIFER	350
MAMBO	350, 351, 352
MAMBO LED	353
MAX	345, 346
MICRO	353
MONET - MONET STRIP	354, 355, 356
NEMO	353, 354
NOA	357, 358
OUTSIDER	359
PAVO	358
RAYA - RAYA MINI	359
STRIPE	356, 357
SURF	360
SWING	357
TOLEDO WALL	362
VITO	361
WAVE	363
XENON	363
ZEN	362, 363



**BOX**

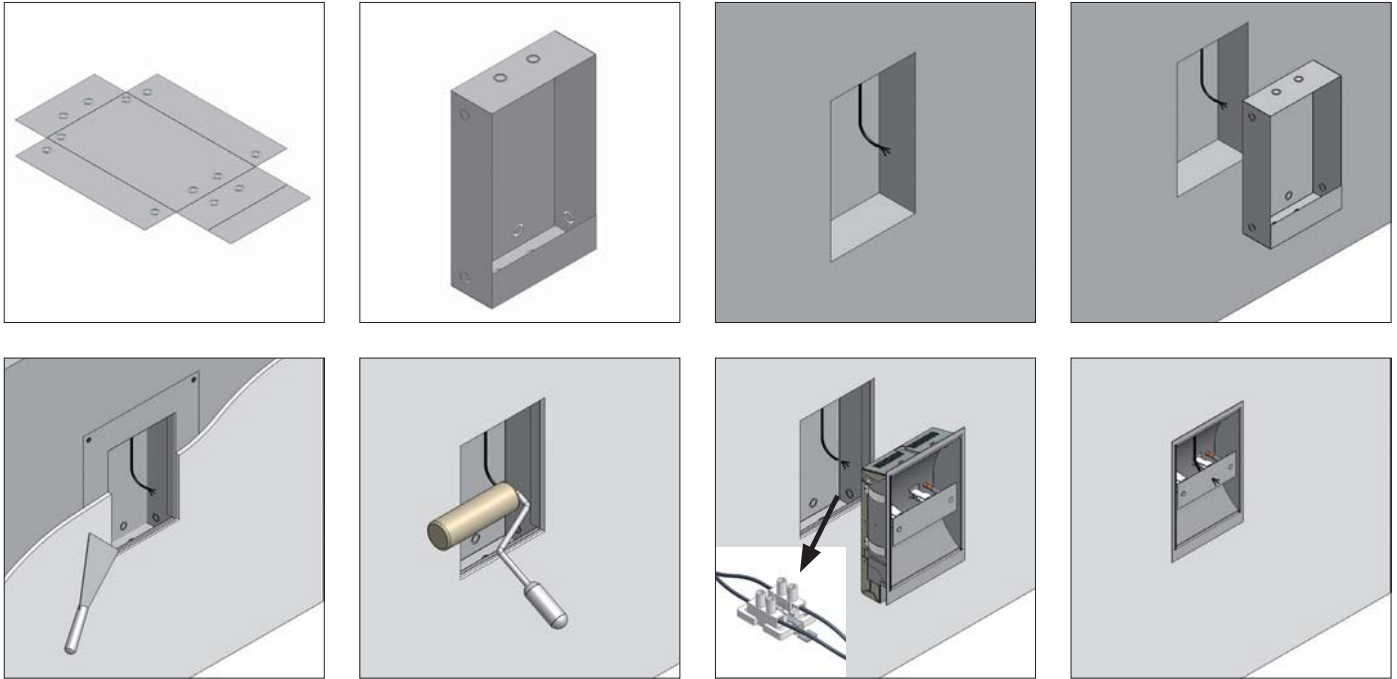

**PLASTERKIT**

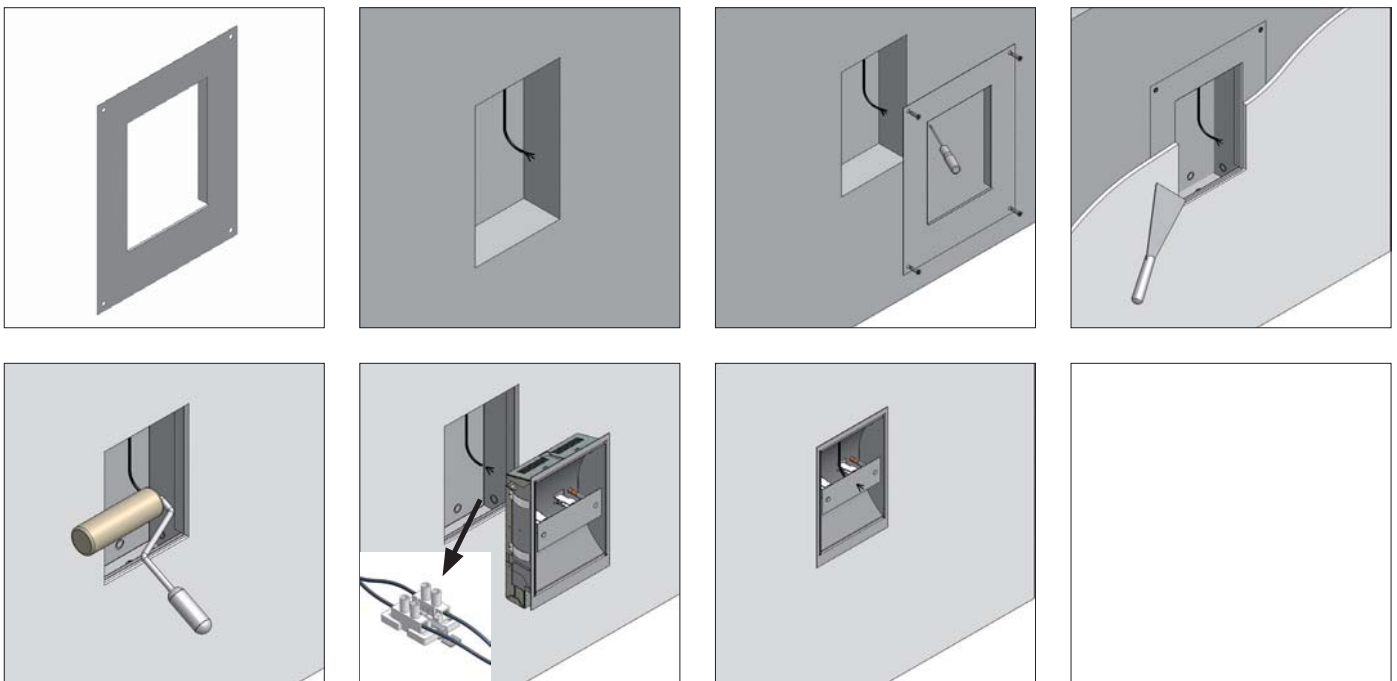

1295A/.. - CALIX

~230V



semi build-in and build-up wall light - standard sandblasted white glass  
Halbeinbau und Halbaufbau Wandleuchte - standard weiß sandgestrahltes Glas

Ref

1295A.14

Lamptype

QT14 G9 (1) 25W 230V

Dimensions

Ø70xD54

Ø32 40

Options

1295F/.. - CALIX box

semi build in/up

1295B/.. - CALIX

~230V



semi build-in and build-up wall light - standard sandblasted white glass  
Halbeinbau und Halbaufbau Wandleuchte - standard weiß sandgestrahltes Glas

Ref

1295B.14

Lamptype

QT14 G9 (1) 25W 230V

Dimensions

Ø70xD54

Ø32 40

Options

1295F/.. - CALIX box

semi build in/up

1295C/.. - CALIX

~230V



semi build-in and build-up wall light - standard sandblasted white glass  
Halbeinbau und Halbaufbau Wandleuchte - standard weiß sandgestrahltes Glas

Ref

1295C.14

Lamptype

QT14 G9 (1) 25W 230V

Dimensions

Ø70xD54

Ø32 40

Options

1295F/.. - CALIX box

semi build in/up

1295D/.. - CALIX

~230V



semi build-in and build-up wall light  
Halbeinbau und Halbaufbau Wandleuchte

Ref

1295D.14

Lamptype

QT14 G9 (1) 25W 230V

Dimensions

Ø70xD54

Ø32 40

Options

1295F/.. - CALIX box

semi build in/up

1295F/.. - CALIX box

IP20    0,0600 



build-in box - box type A-B-C-D  
Einbaudose - Einbaudose Typ A-B-C-D

Ref  
1295F

Dimensions

 Ø72

 Ø68x72

build-in

1295E/.. - CALIX GRANDE

~230V  IP20    0,3500  1 m  05.10.02 



semi build-in and build-up wall light - standard sandblasted white glass  
Halbeinbau und Halbaufbau Wandleuchte - standard weiß sandgestrahltes Glas

Ref  
1295E.14

Lamptype

 QT14 G9 (1) 25W 230V

Dimensions

 Ø80xD45

 Ø32  40

Options

1295G/.. - CALIX box

semi build in/up

1295G/.. - CALIX box

IP20    0,0750 



build-in box - box type E  
Einbaudose - Einbaudose Typ E

Ref  
1295G

Dimensions

 Ø72

 Ø68x72

build-in

1232A/.. - COMPACT

~230V   S2 IP20    1,1300  0,5 m  05.10.50 



build-in wall light - standard opal white glass - with magnetic gear  
Einbau Wandleuchte - standard opalweißes Glas - mit magnetischem Vorschaltgerät

Ref  
1232A.40

Lamptype

 TC-S G23 (1) 9W 230V

Dimensions

 B245xH75xD63

 230x59  70









Options

1234/.. - COMPACT plasterkit

1234B/.. - COMPACT box

build-in  
MAX.9W

1232B/.. - COMPACT

~230V   S2 IP20    1,1300  0,5 m  05.10.50 



build-in wall light - standard opal white glass - with magnetic gear  
Einbau Wandleuchte - standard opalweißes Glas - mit magnetischem Vorschaltgerät

Ref  
1232B.40

**Lamptype**

← TC-S G23 (1) 9W 230V

**Dimensions**

↔ B245xH75xD63

 230x59  70









**Options**

1234/.. - COMPACT plasterkit

1234B/.. - COMPACT box

build-in  
MAX.9W

1232C/.. - COMPACT

~230V   S2 IP20    1,1300  0,5 m  05.10.50 



build-in wall light - standard opal white glass - with magnetic gear  
Einbau Wandleuchte - standard opalweißes Glas - mit magnetischem Vorschaltgerät

Ref  
1232C.40

**Lamptype**

← TC-S G23 (1) 9W 230V

**Dimensions**

↔ B245xH75xD63

 230x59  70

**Options**

1234/.. - COMPACT plasterkit

1234B/.. - COMPACT box

build-in  
MAX.9W

1232D/.. - COMPACT

~230V   S2 IP20    1,1300  0,5 m  05.10.50 



build-in wall light - standard opal white glass - with magnetic gear  
Einbau Wandleuchte - standard opalweißes Glas - mit magnetischem Vorschaltgerät

Ref  
1232D.40

**Lamptype**

← TC-S G23 (1) 9W 230V

**Dimensions**

↔ B245xH75xD63

 230x59  70









**Options**

1234/.. - COMPACT plasterkit

1234B/.. - COMPACT box

build-in  
MAX.9W

1232E/.. - COMPACT

~230V   S2 IP20    1,1300  0,5 m  05.10.50 



build-in wall light - standard opal white glass - with magnetic gear  
Einbau Wandleuchte - standard opalweißes Glas - mit magnetischem Vorschaltgerät

Ref  
1232E.40

**Lamptype**

← TC-S G23 (1) 9W 230V

**Dimensions**

↔ B245xH75xD63

 230x59  70

**Options**

1234/.. - COMPACT plasterkit

1234B/.. - COMPACT box

build-in  
MAX.9W

1232F/.. - COMPACT

~230V   S2 IP20    1,1300  0,5 m  05.10.50 



build-in wall light - standard opal white glass - with magnetic gear  
Einbau Wandleuchte - standard opalweißes Glas - mit magnetischem Vorschaltgerät

Ref  
1232F.40

**Lamptype**

← TC-S G23 (1) 9W 230V

**Dimensions**

↔ B245xH75xD63

 230x59  70

**Options**

1234/.. - COMPACT plasterkit  
1234B/.. - COMPACT box

build-in  
MAX.9W

1232G/.. - COMPACT

~230V   S2 IP20    1,1300  0,5 m  05.10.50 



build-in wall light - standard opal white glass - with magnetic gear  
Einbau Wandleuchte - standard opalweißes Glas - mit magnetischem Vorschaltgerät

Ref  
1232G.40

**Lamptype**

← TC-S G23 (1) 9W 230V

**Dimensions**

↔ B245xH75xD63

 230x59  70

**Options**

1234/.. - COMPACT plasterkit  
1234B/.. - COMPACT box

build-in  
MAX.9W

1232H/.. - COMPACT

~230V   S2 IP20    1,1300  0,5 m  05.10.50 



build-in wall light - standard opal white glass - with magnetic gear  
Einbau Wandleuchte - standard opalweißes Glas - mit magnetischem Vorschaltgerät

Ref  
1232H.40

**Lamptype**

← TC-S G23 (1) 9W 230V

**Dimensions**

↔ B245xH75xD63

 230x59  70

**Options**

1234/.. - COMPACT plasterkit  
1234B/.. - COMPACT box

build-in  
MAX.9W

1234/.. - COMPACT plasterkit

IP20    0,0900 



plasterkit - plasterkit  
Einputzrahmen - Einputzrahmen

Ref  
1234

**Dimensions**

↔ L330xB160

 232x59

**Options**

COMPACT

build-in

1234B/.. - COMPACT box

IP20   



build-in box - build-in box  
Einbaudose - Einbaudose

Ref

1234B

Dimensions

 B240xH70xD92

 240x70

Options

COMPACT

build-in

1235A/.. - SCREEN

~230V  S2 IP20    1,5300  1 m  05.10.02 



build-in wall light - asymmetric  
Einbau Wandleuchte - asymmetrisch

Ref

1235A.10

Lamptype

 QT-DE 12 74,9mm R7s (1) 100W 230V

Dimensions

 B197xH287xD68

 185x255  70

Options

1237/.. - SCREEN plasterkit

1237B/.. - SCREEN box

build-in

MAX.100W - available with even reflector on request  
verfügbar mit ebenem Reflektor auf Anfrage

1235B/.. - SCREEN

~230V  S2 IP20    1,5000  1 m  05.10.02 



build-in wall light - symmetric  
Einbau Wandleuchte - symmetrisch

Ref

1235B.10

Lamptype

 QT-DE 12 74,9mm R7s (1) 100W 230V

Dimensions

 B197xH287xD68

 185x255  70

Options

1237/.. - SCREEN plasterkit

1237B/.. - SCREEN box

build-in

MAX.100W - available with even reflector on request  
verfügbar mit ebenem Reflektor auf Anfrage

1235C/.. - SCREEN

~230V  S2 IP20    1,8000  1 m  05.10.02 



build-in wall light - symmetric - with glass  
Einbau Wandleuchte - symmetrisch - mit Glas

Ref

1235C.10

Lamptype

 QT-DE 12 74,9mm R7s (1) 100W 230V

Dimensions

 B197xH287xD68

 185x255  70

Options

1237/.. - SCREEN plasterkit

1237B/.. - SCREEN box

build-in

MAX.100W - available with even reflector on request  
verfügbar mit ebenem Reflektor auf Anfrage



1236/.. - SCREEN

~230V   S2 IP20    2,1800  0,5 m  05.10.50 



build-in wall light - with glass - with magnetic gear  
Einbau Wandleuchte - mit Glas - mit magnetischem  
Vorschaltgerät

Ref  
1236.10

**Lamptype**

← TC-D G24D-3 (1) 26W 230V

**Dimensions**

↔ B197xH287xD68

 185x255  70

**Options**

1237/.. - SCREEN plasterkit  
1237B/.. - SCREEN box

build-in  
MAX.26W

1236PL18/.. - SCREEN

~230V   S2 IP20    1,5500  0,5 m  05.10.50 



build-in wall light - without glass - with magnetic gear  
Einbau Wandleuchte - ohne Glas - mit magnetischem  
Vorschaltgerät

Ref  
1236PL18.10

**Lamptype**

← TC-D G24D-2 (1) 18W 230V

**Dimensions**

↔ B197xH287xD68

 185x255  70

**Options**

1237/.. - SCREEN plasterkit  
1237B/.. - SCREEN box

build-in  
MAX.18W - available with even reflector on request  
verfügbar mit ebenem Reflektor auf Anfrage

1237/.. - SCREEN plasterkit

IP20    0,1900 



plasterkit  
Einputzrahmen

Ref  
1237

**Dimensions**

↔ B325xH425

 186x256

build-in

1237B/.. - SCREEN box

 IP20    0,3900 





build-in box  
Einbaudose

Ref  
1237B

**Dimensions**

↔ B315xH190xD80

 190x315  81

build-in

1238A/.. - SMALL SCREEN

~12V S2 IP20 0,4550 0,5 m 05.10.02



build-in wall light - without glass - without transformer  
Einbau Wandleuchte - ohne Glas - ohne Trafo

Ref  
1238A.10

Lamptype

QR-CB 35 GU4/GZ4 (1) 35W 12V

Dimensions

B60xH220xD64

52x199 65

Options

1239/.. - SMALL SCREEN plasterkit  
1239B/.. - SMALL SCREEN box VT

build-in  
MAX.35W - with LED on request  
mit LED auf Anfrage

1238B/.. - SMALL SCREEN

~12V S2 IP20 0,7000 0,5 m 05.10.02



build-in wall light - with glass - without transformer  
Einbau Wandleuchte - mit Glas - ohne Trafo

Ref  
1238B.10

Lamptype

QR-CB 35 GU4/GZ4 (1) 35W 12V

Dimensions

B60xH220xD64

52x199 65

Options

1239/.. - SMALL SCREEN plasterkit  
1239B/.. - SMALL SCREEN box VT

build-in  
MAX.35W - 12V - with LED on request  
mit LED auf Anfrage

1239/.. - SMALL SCREEN plasterkit

IP20 0,2300



plasterkit  
Einputzrahmen

Ref  
1239

Dimensions

B152xH327

60x205 65

build-in

1239B/.. - SMALL SCREEN box VT

IP20 0,2000



build-in box  
Einbaudose

Ref  
1239B

Dimensions

B55xH315xD71

55x315 72

build-in

1238C/.. - RECTO SCREEN

~230V  S2 IP20    0,3500  1 m  05.10.02 



build-in wall light  
Einbau Wandleuchte

Ref

1238C.5

1238C.11

Lamptype

 QT14 G9 (1) 40W 230V

Dimensions

 B110xH340xD50

 96x320  70

Options

1239C/.. - RECTO SCREEN box

1239D/.. - RECTO SCREEN plasterkit

build-in

1239C/.. - RECTO SCREEN box

 IP20    0,2300 



build-in box  
Einbaudose

Ref

1239C

Dimensions

 B102xH327xD72

 102x327  73

build-in

1239D/.. - RECTO SCREEN plasterkit

IP20    0,1200 



plasterkit  
Einputzrahmen

Ref

1239D

Dimensions

 B160xH400

 96x320

build-in

1298A/.. - LIMA

~230V   S2 IP20    1,3100  0,5 m  05.10.50 



build-in wall light - standard opal plexi - with magnetic gear  
Einbau Wandleuchte - standard opalenes Plexi - mit  
magnetischem Vorschaltgerät

Ref

1298A.10

Lamptype

 TC-D G24D-3 (1) 26W 230V

Dimensions

 B95xH220xD90

 83x181  100

Options

1298D/.. - LIMA plasterkit

build-in

1298B/.. - LIMA

~230V   S2 IP20    1,2100  0,5 m  05.10.50 



build-in wall light - with magnetic gear  
Einbau Wandleuchte - mit magnetischem Vorschaltgerät

Ref  
1298B.10

Lamptype

TC-D G24D-3 (1) 26W 230V

Dimensions

B95xH220xD90

83x181 100

Options

1298D/.. - LIMA plasterkit

build-in

1298C/.. - LIMA FLAT

~230V   S2 IP20    1,3450  0,5 m  05.10.50 



build-in wall light - with magnetic gear  
Einbau Wandleuchte - mit magnetischem Vorschaltgerät

Ref  
1298C.10

Lamptype

TC-D G24D-3 (1) 26W 230V

Dimensions

B95xH220xD90

83x181 100

Options

1298D/.. - LIMA plasterkit

build-in

1298D/.. - LIMA plasterkit

IP20    0,1000 



plasterkit  
Einputzrahmen

Ref  
1298D

Dimensions

B185xH285

83x181

1403/.. - LOTUS IN

~230V  S2 IP20    1,5100  1 m  05.10.02 



build-in wall light  
Einbau Wandleuchte

Ref  
1403.10

Lamptype

QT-DE 12 74,9mm R7s (1) 100W 230V

Dimensions

B210xH210xD70

175x175 80

Options

1403B/.. - LOTUS box

build-in

1403B/.. - LOTUS box



build-in box  
Einbaudose

Ref

1403B

Dimensions

↔ B175xH175xD75

📏 175x175 ⚙️ 75

build-in

1404/.. - LOTUS IN



build-in wall light  
Einbau Wandleuchte

Ref

1404.10

Lamp type

— QT-DE 12 74,9mm R7s (1) 150W 230V

Dimensions

↔ B200xH300xD70

📏 185x285 ⚙️ 75

Options

1404B/.. - LOTUS box

build-in

1404B/.. - LOTUS box



build-in box  
Einbaudose

Ref

1404B

Dimensions

↔ B185xH285xD75

📏 185x285 ⚙️ 75

build-in

1405/.. - LOTUS IN



build-in wall light  
Einbau Wandleuchte

Ref

1405.10

Lamp type

— QT-DE 12 114,1mm R7s (1) 200W 230V

Dimensions

↔ B300xH300xD70

📏 280x280 ⚙️ 75

Options

1405B/.. - LOTUS box

build-in

1405B/.. - LOTUS box



build-in box  
Einbaudose

Ref

1405B

Dimensions

↔ B280xH280xD75

📏 280x280 ⚙️ 75

build-in

1296B/.. - MEZZO



build-in wall light - with blue glass  
Einbau Wandleuchte - mit blauem Glas

Ref

1296B.14

Lamptype

💡 QT14 G9 (1) 25W 230V

Dimensions

↔ B128xH128xD60

📏 115x115 ⚙️ 65

Options

1296C/.. - MEZZO plasterkit

build-in

1296W/.. - MEZZO



build-in wall light - with opal white glass  
Einbau Wandleuchte - mit opalweißem Glas

Ref

1296W.14

Lamptype

💡 QT14 G9 (1) 25W 230V

Dimensions

↔ B128xH128xD60

📏 115x115 ⚙️ 65

Options

1296C/.. - MEZZO plasterkit

build-in

1296C/.. - MEZZO plasterkit



plasterkit  
Einputzrahmen

Ref

1296C

Dimensions

↔ L215xB215

📏 115x115

1297B/.. - MEZZO GRANDE

~230V  S2 IP20    1,1060  1 m  05.10.02 



build-in wall light - with blue glass  
Einbau Wandleuchte - mit blauem Glas



Ref  
1297B.14

Lamp type

 QT14 G9 (1) 40W 230V

Dimensions

 B200xH200xD65

 175x175  70

Options

1297C/.. - MEZZO GRANDE plasterkit

build-in

1297W/.. - MEZZO GRANDE

~230V  S2 IP20    1,1060  1 m  05.10.02 



build-in wall light - with opal white glass  
Einbau Wandleuchte - mit opalweißem Glas



Ref  
1297W.14

Lamp type

 QT14 G9 (1) 40W 230V

Dimensions

 B200xH200xD65

 175x175  70

Options

1297C/.. - MEZZO GRANDE plasterkit

build-in

1297C/.. - MEZZO GRANDE plasterkit

IP20    0,1160 

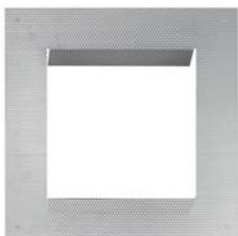

plasterkit  
Einputzrahmen

Ref  
1297C

Dimensions

 L275xB275

 175x175

1299/.. - MIKA

~230V   S2 IP20    1,7230  0,5 m  05.10.50 



build-in wall light - with magnetic gear  
Einbau Wandleuchte - mit magnetischem Vorschaltgerät

Ref  
1299.10  
1299.10.B  
1299.10.R

Lamp type

 TC-D G24D-3 (1) 26W 230V

Dimensions

 B220xH220xD60

 206x206  70

Options

1299A/.. - MIKA plasterkit

build-in  
colour filter blue(B) or red(R)  
Farbfilter Blau(B) oder Rot(R)

1299A/.. - MIKA plasterkit

IP20    0.1350 

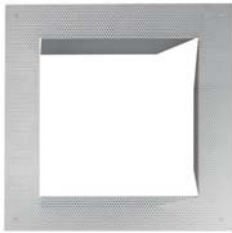

plasterkit  
Einputzrahmen

Ref

1299A

Dimensions

 L300xB300

 206x206

1299X/.. - MIKA GRANDE

~230V   S2 IP20    3.5270  0.5 m  05.10.50 



build-in wall light - with electronic gear  
Einbau Wandleuchte - mit elektronischem Vorschaltgerät

Ref

1299X.10

1299X.10.B

1299X.10.R

Lamp type

 T16FQ T5 G5 (1) 24W 230V

Dimensions

 B600xH220xD60

 585x206  70

Options

1299XA/.. - MIKA GRANDE plasterkit

build-in  
colour filter blue(B) or red(R)  
Farbfilter Blau(B) oder Rot(R)

1299XA/.. - MIKA GRANDE plasterkit

IP20    0.3000 



plasterkit  
Einputzrahmen

Ref

1299XA

Dimensions

 B688xH300

 585x206

1230A/.. - MIRO

~12V   S2 IP20    0.3200  0.5 m  05.10.02 



build-in wall light - without transformer  
Einbau Wandleuchte - ohne Trafo

Ref

1230A.40

Lamp type

 QT9-ax G4 (1) 10W 12V

Dimensions

 B90xH90xD60

 79x68  61

Options

1231/.. - MIRO plasterkit

build-in  
MAX.5-10W - 12V



1230B/.. - MIRO

~12V S2 IP20 0,3200 0,5 m 05.10.02



build-in wall light - without transformer  
Einbau Wandleuchte - ohne Trafo

Ref  
1230B.40

Lamptype

QT9-ax G4 (1) 10W 12V

Dimensions

B90xH90xD60

79x68 61

Options

1231/.. - MIRO plasterkit

build-in  
MAX.5-10W - 12V

1230C/.. - MIRO

~12V S2 IP20 0,3200 0,5 m 05.10.02



build-in wall light - without transformer  
Einbau Wandleuchte - ohne Trafo

Ref  
1230C.40

Lamptype

QT9-ax G4 (1) 10W 12V

Dimensions

B90xH90xD60

79x68 61

Options

1231/.. - MIRO plasterkit

build-in  
MAX.5-10W - 12V

1230D/.. - MIRO

~12V S2 IP20 0,3200 0,5 m 05.10.02



build-in wall light - without transformer  
Einbau Wandleuchte - ohne Trafo

Ref  
1230D.40

Lamptype

QT9-ax G4 (1) 10W 12V

Dimensions

B90xH90xD60

79x68 61

Options

1231/.. - MIRO plasterkit

build-in  
MAX.5-10W - 12V

1230E/.. - MIRO

~12V S2 IP20 0,3200 0,5 m 05.10.02



build-in wall light - without transformer  
Einbau Wandleuchte - ohne Trafo

Ref  
1230E.40

Lamptype

QT9-ax G4 (1) 10W 12V

Dimensions

B90xH90xD60

79x68 61

Options

1231/.. - MIRO plasterkit

build-in  
MAX.5-10W - 12V

1230F/.. - MIRO

~12V S2 IP20 0,3200 0,5 m 05.10.02



build-in wall light - without transformer  
Einbau Wandleuchte - ohne Trafo

Ref  
1230F.40

Lamptype

QT9-ax G4 (1) 10W 12V

Dimensions

B90xH90xD60

79x68 61

Options

1231/.. - MIRO plasterkit

build-in  
MAX.5-10W - 12V

1230G/.. - MIRO

~12V S2 IP20 0,3200 0,5 m 05.10.02



build-in wall light - without transformer  
Einbau Wandleuchte - ohne Trafo

Ref  
1230G.40

Lamptype

QT9-ax G4 (1) 10W 12V

Dimensions

B90xH90xD60

79x68 61

Options

1231/.. - MIRO plasterkit

build-in  
MAX.5-10W - 12V

1230H/.. - MIRO

~12V S2 IP20 0,3200 0,5 m 05.10.02



build-in wall light - without transformer  
Einbau Wandleuchte - ohne Trafo

Ref  
1230H.40

Lamptype

QT9-ax G4 (1) 10W 12V

Dimensions

B90xH90xD60

79x68 61

Options

1231/.. - MIRO plasterkit

build-in  
MAX.5-10W - 12V

1231/.. - MIRO plasterkit

IP20 0,3200

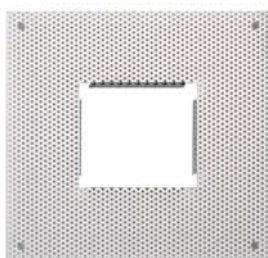

plasterkit  
Einputzrahmen

Ref  
1231

Dimensions

L180xB170

79x68

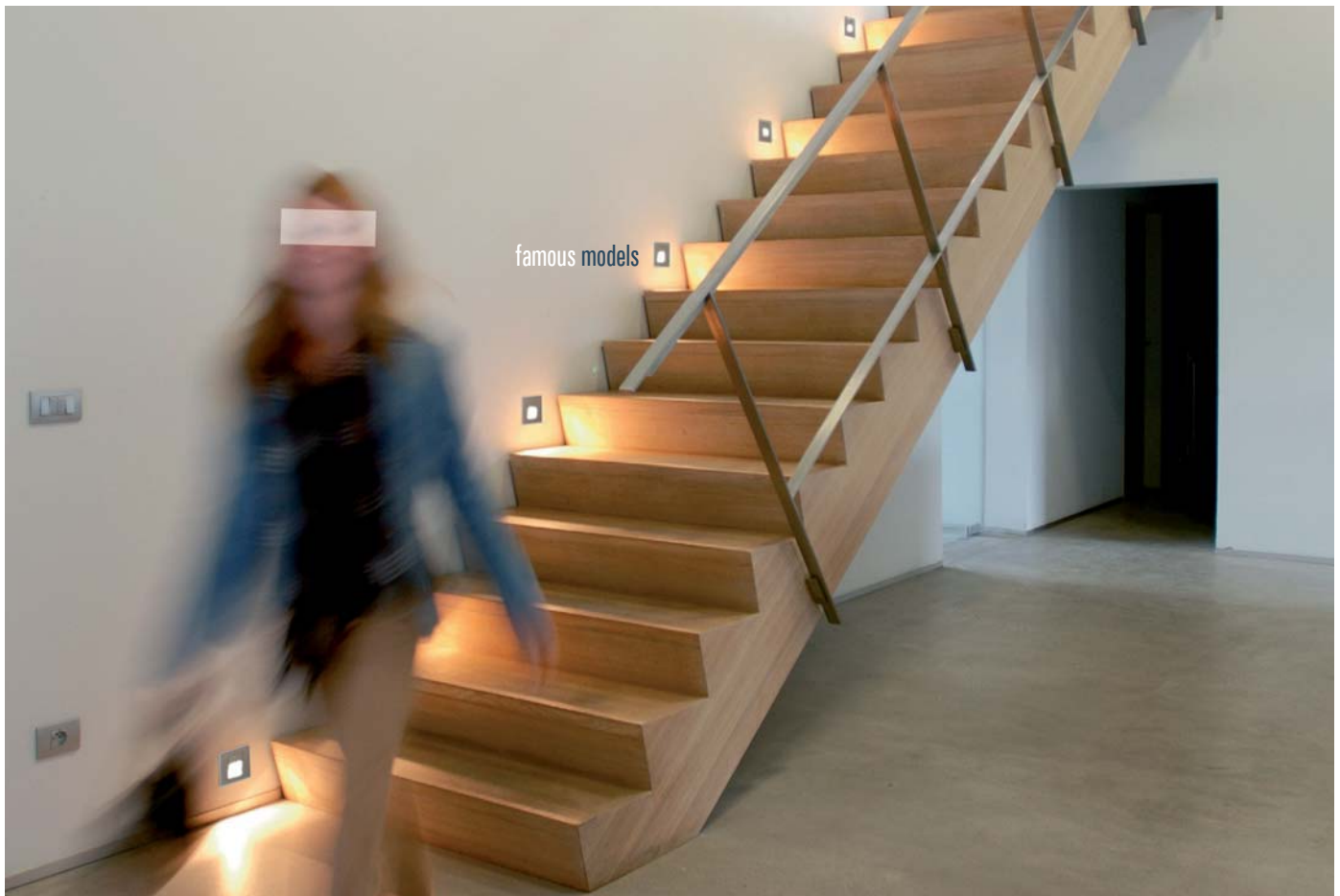

1244/.. - SINGLE MOON

~12V S2 IP20 0,4020 0,5 m 05.10.02



build-in wall light - without transformer  
Einbau Wandleuchte - ohne Trafo

Ref

Lamp type

QT9-ax G4 (1) 20W 12V

Dimensions

B100xH90xD55

85x80 60

Options

1245A/.. - SINGLE MOON box ZT

1245B/.. - SINGLE MOON box VT

1244.1  
1244.4  
1244.5  
1244.13  
1244.16

build-in

1244/.. /GLASS - SINGLE MOON + GLASS

~12V S2 IP20 0,4700 0,5 m 05.10.02



build-in wall light - with glass - without transformer  
Einbau Wandleuchte - mit Glas - ohne Trafo

Ref

Lamp type

QT9-ax G4 (1) 20W 12V

Dimensions

B100xH90xD55

85x80 60

Options

1245A/.. - SINGLE MOON box ZT

1245B/.. - SINGLE MOON box VT

1244.5.GLASS  
1244.13.GLASS  
1244.16.GLASS

build-in

1245A/.. - SINGLE MOON box ZT

IP20   0,0650 



build-in box - no room for transformer  
Einbaudose - kein Platz für Trafo

Ref

1245A

Dimensions

 B85xH80xD60

build-in

1245B/.. - SINGLE MOON box VT

~230V  IP20   0,1500 



build-in box - with room for transformer  
Einbaudose - mit Platz für Trafo

Ref

1245B

Dimensions

 B85xH205xD55

build-in

1246/.. - TRIPLE MOON

~12V    S2 IP20   0,6800  0,5 m  



build-in wall light - without transformer  
Einbau Wandleuchte - ohne Trafo

Ref

1246.5

Lamptype

 QT9-ax G4 (3) 20W 12V

1246.13

1246.16

Dimensions

 B180xH90xD55

 165x76  60

Options

1247A/.. - TRIPLE MOON box ZT

1247B/.. - TRIPLE MOON box VT

build-in

1246/..GLASS - TRIPLE MOON + GLASS

~12V    S2 IP20   0,8000  0,5 m  



build-in wall light - with glass - without transformer  
Einbau Wandleuchte - mit Glas - ohne Trafo

Ref

1246.5.GLASS

Lamptype

 QT9-ax G4 (3) 20W 12V

1246.13.GLASS

1246.16.GLASS

Dimensions

 B180xH90xD55

 165x76  60

Options

1247A/.. - TRIPLE MOON box ZT

1247B/.. - TRIPLE MOON box VT

build-in

1247A/.. - TRIPLE MOON box ZT

IP20    0,1000 



build-in box - no room for transformer  
Einbaudose - kein Platz für Trafo

Ref

1247A

Dimensions

 B165xH80xD60

build-in

1247B/.. - TRIPLE MOON box VT

~230V  IP20    0,2000 



build-in box - with room for transformer  
Einbaudose - mit Platz für Trafo

Ref

1247B

Dimensions

 B165xH150xD65

build-in

1248/.. - MOON

~12V   S2 IP20    1,3200  0,5 m  05.10.02 



build-in wall light - without transformer  
Einbau Wandleuchte - ohne Trafo

Ref

1248.5

Lamptype

 QT12 GY6,35 (3) 20W 12V

1248.13

1248.16

Dimensions

 B180xH180xD65

 166x166  70

Options

1249A/.. - MOON box ZT

1249B/.. - MOON box VT

build-in

1248/..GLASS - MOON + GLASS

~12V   S2 IP20    1,5500  0,5 m  05.10.02 



build-in wall light - without transformer  
Einbau Wandleuchte - ohne Trafo

Ref

1248.5.GLASS

Lamptype



 QT12 GY6,35 (3) 20W 12V

1248.13.GLASS

1248.16.GLASS

Dimensions

 B180xH180xD65

 166x166  70

Options

1249A/.. - MOON box ZT

1249B/.. - MOON box VT

build-in

1249A/.. - MOON box ZT

IP20    0,1900 



build-in box - no room for transformer  
Einbaudose - kein Platz für Trafo

Ref

1249A

Dimensions

 B168xH165xD72

build-in

1249B/.. - MOON box VT

~230V  IP20    0,3000 



build-in box - with room for transformer  
Einbaudose - mit Platz für Trafo

Ref

1249B

Dimensions

 B165xH240xD72

build-in

1240/.. - SUN

~12V   S2 IP20    0,3420  0,5 m  05.10.02 



build-in wall light - without transformer  
Einbau Wandleuchte - ohne Trafo

Ref

1240.1

Lamp type

 QT9-ax G4 (1) 20W 12V

1240.7

1240.11

Dimensions

 Ø92xH55

1240.13

 Ø80  60

1240.14

1240.16

Options

1241A/.. - SUN

1241B/.. - SUN

build-in

1240/.. /GLASS - SUN + GLASS

~12V   S2 IP20    0,3420  0,5 m  05.10.02 



build-in wall light - without transformer  
Einbau Wandleuchte - ohne Trafo

Ref

1240.1.GLASS

Lamp type

 QT9-ax G4 (1) 20W 12V

1240.4.GLASS

1240.13.GLASS

Dimensions

 Ø92xH55

1240.14.GLASS

 Ø80  60

1240.16.GLASS

Options

1241A/.. - SUN

1241B/.. - SUN

build-in

1241A/.. - SUN

IP20    0,1500 



build-in box - no room for transformer  
Einbaudose - kein Platz für Trafo

Ref

1241A

Dimensions

 Ø80xH67

build-in

1241B/.. - SUN

~230V  IP20    0,2000 

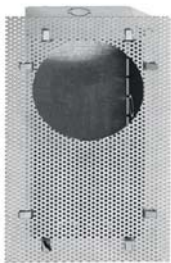

build-in box - with room for transformer  
Einbaudose - mit Platz für Trafo

Ref

1241B

Dimensions

 B85xH170xD65

build-in

1242/.. - SUNGLASS

~12V   S2 IP20    0,1550  0,5 m  05.10.02 



build-in wall light - without transformer  
Einbau Wandleuchte - ohne Trafo

Ref

1242.1

Lamptype

 QT9-ax G4 (1) 10W 12V

1242.11

1242.14

Dimensions

 Ø87xH50

1242.16

 Ø75  50

Options

1243A/.. - SUNGLASS

1243B/.. - SUNGLASS

build-in

1243A/.. - SUNGLASS

IP20    0,1500 



build-in box - no room for transformer  
Einbaudose - kein Platz für Trafo

Ref

1243A

Dimensions

 Ø80xH67

build-in

1243B/.. - SUNGLASS

~230V



IP20



0,2050

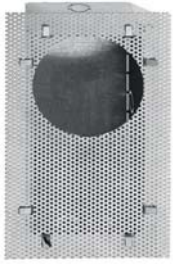

build-in box - with room for transformer  
Einbaudose - mit Platz für Trafo

Dimensions

↔ B85xH170xD65

Ref

1243B

build-in

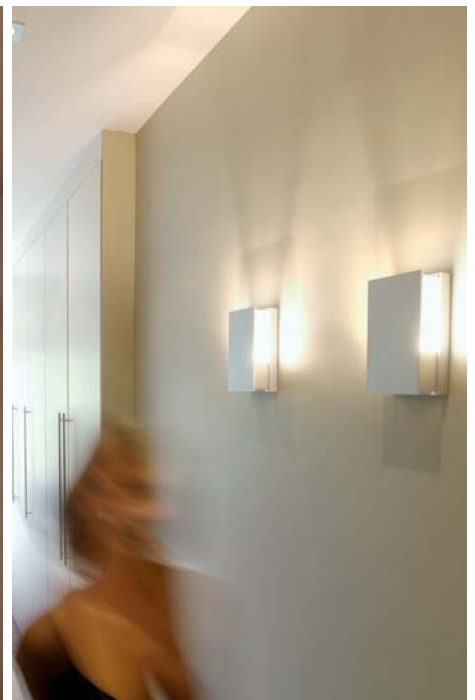



WALL LIGHTS TO BUILD UP

ARC	335
ARCADE	334
AURA	334
AZUR	334
BETAPLUS	335, 336, 337
CANARIA	339
CANVAS A / B	338
CLUB	339
COMMA	340, 341
DISPLAY	341, 342, 343
FLATFACE	343
FORUM	344
GENIO	343
GOYA	344
GRAN CANARIA	339
GUILIA	344, 345
HAVANA	346, 347
KOBUS	348
LARA	348
LOFT	348
LOLA	349
LOTUS UP	349
LUCIFER	350
MAMBO	350, 351, 352
MAMBO LED	353
MAX	345, 346
MICRO	353
MONET - MONET STRIP	354, 355, 356
NEMO	353, 354
NOA	357, 358
OUTSIDER	359
PAVO	358
RAYA - RAYA MINI	359
STRIPE	356, 357
SURF	360
SWING	357
TOLEDO WALL	362
VITO	361
WAVE	363
XENON	363
ZEN	362, 363

**AURA**

3015/.. P.334



**AZUR**

1202/.. P.334



**ARCADE**

3080/.. P.334



**ARC**

3044/.. P.335



**BETA**

1752.ESS0/.. P.336



**CANVAS**

1420W/.. P.338



**CLUB**

1285/.. P.339



**CANARIA**

1430/.. P.339



**COMMA**

3005.DISCUS/.. P.340



**DISPLAY**

3006/.. P.341



**LOTUS**

1401/.. P.349



**FLATFACE**

1289/.. P.343



**GENIO**

1606/.. P.343



**FORUM**

1290/.. P.344



**GOYA**

1605/.. P.344



**GUILIA**

4026.W1/.. P.344



**MAX**

4025.W2/.. P.346



**HAVANA**

1266/.. P.347



**KOBUS**

4024/.. P.348

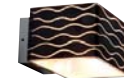

**LARA**

1600/.. P.348



**LOFT**

3036/.. P.348



**LOLA**

3017/.. P.349



**LUCIFER**

3002A/.. P.350



**MAMBO**

3030/.. P.350



**MAMBO LED**

3028/.. P.353



**MICRO**

3043/.. P.353



**NEMO**

3042/..T1 P.353



**MONET**

641.HL335/.. P.354



**STRIPE**

646.1200/.. P.356



**SWING**

3001/.. P.357



**NOA**

4018/.. P.357



**PAVO**

1272/.. P.358



**OUTSIDER**

1250/.. P.359



**RAYA**

3040/.. P.359



**SURF**

1270/.. P.360



**VITO**

3011/.. P.361



**TOLEDO**

3076/.. P.362.



**ZEN**

1281/.. P.362



**XENON**

1294/..W P.363



**WAVE**

1500/.. P.363



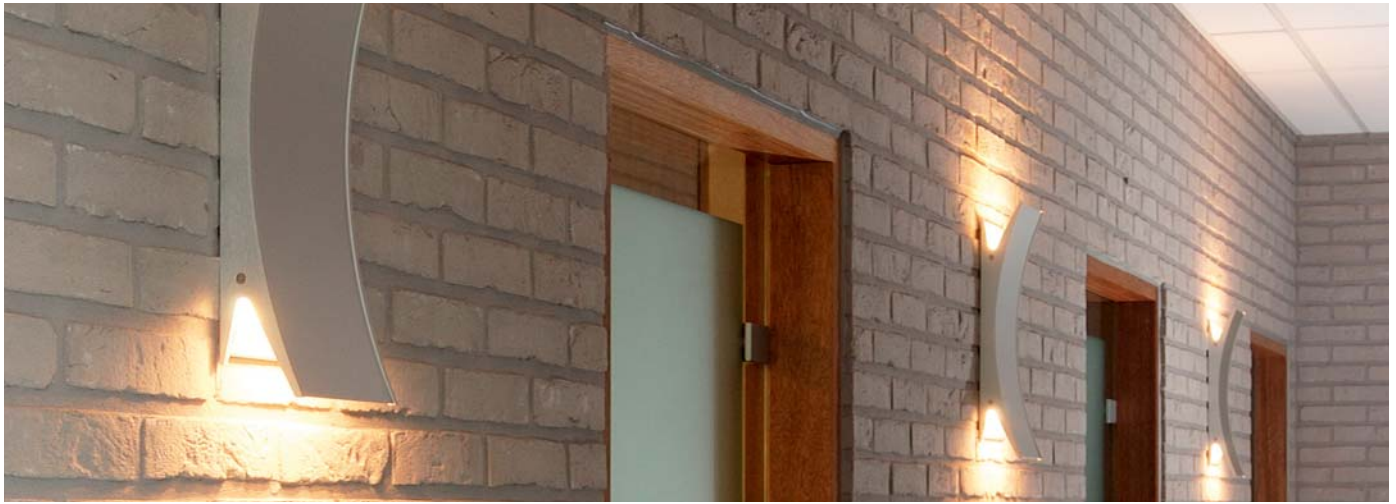

**3015/.. - AURA**

~230V  IP44    0,6750  0,5 m  05.10.50 



build-up wall light - with electronic gear  
Wandleuchte für Aufbau - mit elektronischem Vorschaltgerät

**Ref**

3015.10

3015.40

**Lamptype**

⇒ T16FQ T5 G5 (1) 24W 230V

**Dimensions**

↔ B590xH80xD30



build-up  
for bathrooms  
für Badezimmer

**1202/.. - AZUR**

~230V  IP20    1 m  05.10.02 



build-up wall light - with transformer  
Wandleuchte für Aufbau - mit Trafo

**Ref**

1202.40

**Lamptype**

⊏ QR-LP111 G53 (1) 50W 12V

**Dimensions**

↔ B140xH120xD205



build-up  
60VA

**3080/.. - ARCADE**

~230V  IP20    0,3500  0,5 m  05.10.02 



build-up wall light  
Wandleuchte für Aufbau

**Ref**

3080.11

**Lamptype**

⊏ TC-FSE GX53 (1) 9W 230V

**Dimensions**

↔ B110xH275xD95

⊠ L80xB80



build-up

3044/.. - ARC

~230V



build-up wall light  
Wandleuchte für Aufbau

Ref

3044.40

Lamptype

— QT-DE 12 74,9mm R7s (2) 100W 230V

Dimensions

↔ B162xH410xD65

build-up  
with LED on request  
mit LED auf Anfrage

1750.ES50/.. - BETAPLUS

~230V



build-up wall light - fixed  
Wandleuchte für Aufbau - fest

Ref

1750.ES50.1M

1750.ES50.2M

1750.ES50.7

1750.ES50.11M

1750.ES50.14.5

Lamptype

◀ QPAR 51 GU10 (1) 35W 230V

Dimensions

↔ B90xH100xD115

⚡ L60xB60

build-up

1750.ES63/.. - BETAPLUS

~230V



build-up wall light - fixed  
Wandleuchte für Aufbau - fest

Ref

1750.ES63.1M

1750.ES63.2M

1750.ES63.7

1750.ES63.11M

1750.ES63.14.5

Lamptype

◀ QPAR64 GU10 (1) 75W 230V

Dimensions

↔ B90xH100xD115

⚡ L60xB60

build-up

1750.MEGA/.. - BETAPLUS

~230V



build-up wall light - fixed  
Wandleuchte für Aufbau - fest

Ref

1750.MEGA.1M

1750.MEGA.2M

1750.MEGA.7

1750.MEGA.11M

1750.MEGA.14.5

Lamptype

◀ QPAR 51 GU10 (1) 11W 230V

Dimensions

↔ B90xH100xD115

⚡ L60xB60

build-up

1751.ES50/.. - BETAPLUS

~230V IP20 0,1840 1 m 05.10.02



build-up wall light - directional  
Wandleuchte für Aufbau - schwenkbar

**Lamptype**

QPAR 51 GU10 (1) 35W 230V

**Dimensions**

B90xH100xD115

L60xB60

**Ref**

- 1751.ES50.1M
- 1751.ES50.2M
- 1751.ES50.7
- 1751.ES50.11M
- 1751.ES50.14.11

build-up

1752.ES50/.. - BETAPLUS

~230V IP20 0,1840 1 m 05.10.02



build-up wall light - luminaire directional - cassette fix  
Wandleuchte für Aufbau - Leuchte schwenkbar - Kassette fest

**Lamptype**

QPAR 51 GU10 (1) 35W 230V

**Dimensions**

B90xH100xD115

L60xB60

**Ref**

- 1752.ES50.1M
- 1752.ES50.2M
- 1752.ES50.7
- 1752.ES50.11M
- 1752.ES50.14.5

build-up  
directional cassette on request  
drehbare Kassette auf Anfrage

1753.ES50/.. - BETAPLUS

~230V IP20 0,1840 1 m 05.10.02



build-up wall light - fixed - with glass  
Wandleuchte für Aufbau - fest - mit Glas

**Lamptype**

QPAR 51 GU10 (1) 35W 230V

**Dimensions**

B90xH100xD115

L60xB60

**Ref**

- 1753.ES50.1M
- 1753.ES50.2M
- 1753.ES50.7
- 1753.ES50.11M
- 1753.ES50.14.5

build-up

1754.ES50/.. - BETAPLUS

~230V IP20 0,1840 1 m 05.10.02



build-up wall light - fixed  
Wandleuchte für Aufbau - fest

**Lamptype**

QPAR 51 GU10 (2) 35W 230V

**Dimensions**

B162xH100xD115

L60xB60

**Ref**

- 1754.ES50.1M
- 1754.ES50.2M
- 1754.ES50.7
- 1754.ES50.11M
- 1754.ES50.14.5

build-up

1754.MEGA/.. - BETAPLUS

~230V IP20 1 m 05.10.02



build-up wall light - fixed  
Wandleuchte für Aufbau - fest

**Lamptype**  
QPAR 51 GU10 (2) 11W 230V

**Dimensions**  
B162xH100xD115  
L60xB60

**Ref**  
1754.MEGA.1M  
1754.MEGA.2M  
1754.MEGA.7  
1754.MEGA.11M  
1754.MEGA.14.5

build-up

1755.ES50/.. - BETAPLUS

~230V IP20 1 m 05.10.02



build-up wall light - directional  
Wandleuchte für Aufbau - schwenkbar

**Lamptype**  
QPAR 51 GU10 (2) 35W 230V

**Dimensions**  
B162xH100xD115  
L60xB60

**Ref**  
1755.ES50.1M  
1755.ES50.2M  
1755.ES50.7  
1755.ES50.11M  
1755.ES50.14.11

build-up

1756.ES50/.. - BETAPLUS

~230V IP20 1 m 05.10.02



build-up wall light - with glass  
Wandleuchte für Aufbau - mit Glas

**Lamptype**  
QPAR 51 GU10 (2) 35W 230V

**Dimensions**  
B162xH100xD115  
L60xB60

**Ref**  
1756.ES50.1M  
1756.ES50.2M  
1756.ES50.7  
1756.ES50.11M  
1756.ES50.14.5

build-up

1717.TCDE/.. - BETAPLUS

~230V IP20 0.1130 0.5 m 05.10.50



build-up wall light - with glass - with electronic gear  
Wandleuchte für Aufbau - mit Glas - mit elektronischem  
Vorschaltgerät

**Lamptype**  
TC-DEL G24Q2 (1) 18W 230V

**Dimensions**  
B232xH110xD115  
L60xB60

**Ref**  
1717.TCDE.1M  
1717.TCDE.2M  
1717.TCDE.7  
1717.TCDE.11M  
1717.TCDE.14.5

build-up

1420W/.. - CANVAS A

~230V



build-up wall light - with opal white glass  
Wandleuchte für Aufbau - mit opalweißem Glas

Ref

1420W.14

Lamp type

QT14 G9 (1) 25W 230V

Dimensions

B120xH120xD63

L80xB70

build-up

1420B/.. - CANVAS A

~230V



build-up wall light - with blue glass  
Wandleuchte für Aufbau - mit blauem Glas

Ref

1420B.14

Lamp type

QT14 G9 (1) 25W 230V

Dimensions

B120xH120xD63

L80xB70

build-up

1421W/.. - CANVAS B

~230V



build-up wall light - with opal white glass  
Wandleuchte für Aufbau - mit opalweißem Glas

Ref

1421W.14

Lamp type

QT14 G9 (1) 40W 230V

Dimensions

B200xH200xD63

L125xB115

build-up

1421B/.. - CANVAS B

~230V



build-up wall light - with blue glass  
Wandleuchte für Aufbau - mit blauem Glas

Ref

1421B.14

Lamp type

QT14 G9 (1) 40W 230V

Dimensions

B200xH200xD63

L125xB115

build-up

1285/.. - CLUB

~230V



build-up wall light  
Wandleuchte für Aufbau

Ref

1285.11

Lamp type

QT14 G9 (1) 40W

230V

1285.14

Dimensions

Ø59xD115

Ø59



build-up

1430/.. - CANARIA

~230V



build-up wall light - with magnetic gear  
Wandleuchte für Aufbau - mit magnetischem Vorschaltgerät

Ref

1430.14

Lamp type

TC-L 2G11 (1) 24W

230V

Dimensions

B60xH555xD85

B35xH150



build-up

1431/.. - GRAN CANARIA

~230V



build-up wall light - with transformer  
Wandleuchte für Aufbau - mit Trafo

Ref

1431.14

Lamp type

QR-CB 51 coolfit GU5,3/GX5,3 (1) 50W

12V

Dimensions

B60xH1800xD75

B30xH650



build-up  
60VA - use coolfit lamp  
Coolfit-Lampe verwenden

1432/.. - GRAN CANARIA

~230V



build-up wall light - orientation light below - with magnetic gear  
Wandleuchte für Aufbau - Orientierungsleuchte unten - mit magnetischem Vorschaltgerät

Ref

1432.14

Lamp type

TC-L 2G11 (1) 36W

230V

TC-S G23 (1) 11W

230V

Dimensions

B60xH1800xD80

2xB40x2xH40



build-up  
2 circuits  
2 Stromkreise

**3004.DISCUS/.. - COMMA 12V - M10**

~12V

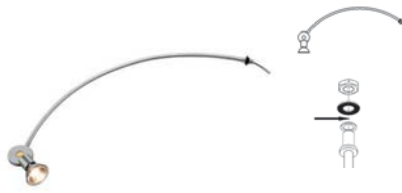

build-up spot M10 - without transformer  
Aufbaustrahler M10 - ohne Trafo

**Lamptype**  
QR-CB 51 GU5,3/GX5,3 (1) 50W 12V

**Dimensions**  
D350

**Ref**  
3004.DISCUS.1  
3004.DISCUS.2  
3004.DISCUS.4  
3004.DISCUS.7  
3004.DISCUS.11  
3004.DISCUS.13  
3004.DISCUS.14  
3004.DISCUS.16

**build-up**  
standard 500mm - 200-300-400mm on request  
standard 500mm - 200-300-400mm auf Anfrage

**3004.JUPITER/.. - COMMA 12V - M10**

~12V



build-up spot M10 - without transformer  
Aufbaustrahler M10 - ohne Trafo

**Lamptype**  
QR-CB 51 coolfit GU5,3/GX5,3 (1) 35W 12V

**Dimensions**  
D350

**Ref**  
3004.JUPITER.1  
3004.JUPITER.2  
3004.JUPITER.4  
3004.JUPITER.7  
3004.JUPITER.11  
3004.JUPITER.13  
3004.JUPITER.14  
3004.JUPITER.16

**build-up**  
standard 500mm - 200-300-400mm on request - use  
coolfit lamp  
standard 500mm - 200-300-400mm auf Anfrage -  
Coolfit-Lampe verwenden

**3004.STEP/.. - COMMA 12V - M10**

~12V



build-up spot M10 - without transformer  
Aufbaustrahler M10 - ohne Trafo

**Lamptype**  
QR-CB 51 GU5,3/GX5,3 (1) 50W 12V

**Dimensions**  
D350

**Ref**  
3004.STEP.1  
3004.STEP.2  
3004.STEP.4  
3004.STEP.7  
3004.STEP.11  
3004.STEP.13  
3004.STEP.14  
3004.STEP.16

**build-up**  
standard 500mm - 200-300-400mm on request  
standard 500mm - 200-300-400mm auf Anfrage

**3005.DISCUS/.. - COMMA MT**

~230V



build-up wall light - with transformer  
Wandleuchte für Aufbau - mit Trafo

**Lamptype**  
QR-CB 51 GU5,3/GX5,3 (1) 50W 12V

**Dimensions**  
L590xB350  
L90xB39

**Ref**  
3005.DISCUS.1  
3005.DISCUS.2  
3005.DISCUS.4  
3005.DISCUS.7  
3005.DISCUS.11  
3005.DISCUS.13  
3005.DISCUS.14  
3005.DISCUS.16

**build-up**  
60VA - standard 500mm max. - 200-300-400mm on  
request  
60VA - standard 500mm max. - 200-300-400mm auf  
Anfrage



**3005.JUPITER/.. - COMMA MT**

~230V   IP20     0,5870  0,5 m  05.10.02 



build-up wall light - with transformer  
Wandleuchte für Aufbau - mit Trafo

**Lamp type**

QR-CB 51 coolfit GU5,3/GX5,3 (1) 35W 12V

**Dimensions**

L590xB350

L90xB39

**Ref**

- 3005.JUPITER.1
- 3005.JUPITER.2
- 3005.JUPITER.4
- 3005.JUPITER.7
- 3005.JUPITER.11
- 3005.JUPITER.13
- 3005.JUPITER.14
- 3005.JUPITER.16

**build-up**

60VA - standard 500mm max. - 200-300-400mm on request - use coolfit lamp  
60VA - standard 500mm max. - 200-300-400mm auf Anfrage - Coolfit- Lampe verwenden

**3005.STEP/.. - COMMA MT**

~230V   IP20     0,5845  0,5 m  05.10.02 



build-up wall light - with transformer  
Wandleuchte für Aufbau - mit Trafo

**Lamp type**

QR-CB 51 GU5,3/GX5,3 (1) 50W 12V

**Dimensions**

L590xB350

L90xB39

**Ref**

- 3005.STEP.1
- 3005.STEP.2
- 3005.STEP.4
- 3005.STEP.7
- 3005.STEP.11
- 3005.STEP.13
- 3005.STEP.14
- 3005.STEP.16

**build-up**

60VA - standard 500mm max. - 200-300-400mm on request  
60VA - standard 500mm max. - 200-300-400mm auf Anfrage

**3006/.. - DISPLAY**

~230V   IP20     0,6000  0,5 m  05.10.02 



display lighting - directional - clip max 35mm - with transformer  
Beleuchtung für Schaufenster - schwenkbar - clip max 35mm - mit Trafo

**Lamp type**

QR-CB 51 GU5,3/GX5,3 (1) 50W 12V

**Dimensions**

H350xD500

**Ref**

- 3006.1
- 3006.2
- 3006.11
- 3006.14

**build-up**

60VA - other lengths available on request - straight rod  
andere Längen auf Anfrage - gerade Stange

**3006/..T - DISPLAY**

~230V   IP20     0,5 m  05.10.02 



display lighting - directional - clip max 35mm - with transformer  
Beleuchtung für Schaufenster - schwenkbar - clip max 35mm - mit Trafo

**Lamp type**

QR-CB 51 GU5,3/GX5,3 (1) 50W 12V

**Dimensions**

H350xD500

**Ref**

- 3006.1.T
- 3006.2.T
- 3006.11.T

**build-up**

60VA - other lengths available on request - straight rod + knee joint  
andere Längen auf Anfrage - gerade Stange + Kniegelenk

**3007.DISCUS/.. /25 - DISPLAY**

~230V   IP20     0,1500  0,5 m  05.10.02 



display lighting - clip 25mm - with transformer  
Beleuchtung für Schaufenster - clip 25mm - mit Trafo

**Lamptype**  
 <img alt="QR-CB 51 GU5,3/GX5,3 (1) 50W" data-bbox="350 160 375 175"/> QR-CB 51 GU5,3/GX5,3 (1) 50W 12V

**Dimensions**  
 <img alt="H350xD590" data-bbox="350 190 375 205"/> H350xD590  
 <img alt="L90xB90xH39" data-bbox="350 205 375 220"/> L90xB90xH39

**Ref**  
 3007.DISCUS.1.25  
 3007.DISCUS.2.25  
 3007.DISCUS.11.25  
 3007.DISCUS.14.25

**build-up**  
 60VA - cable 1,5m - curved rod  
 Kabel 1,5m - gekrümmte Stange

**3007.JUPITER/.. /25 - DISPLAY**

~230V   IP20     0,5 m  05.10.02 



display lighting - clip 25mm - with transformer  
Beleuchtung für Schaufenster - clip 25mm - mit Trafo

**Lamptype**  
 <img alt="QR-CB 51 GU5,3/GX5,3 (1) 50W" data-bbox="350 371 375 386"/> QR-CB 51 GU5,3/GX5,3 (1) 50W 12V

**Dimensions**  
 <img alt="H350xD590" data-bbox="350 401 375 416"/> H350xD590  
 <img alt="L90xB90xH39" data-bbox="350 416 375 431"/> L90xB90xH39

**Ref**  
 3007.JUPITER.1.25  
 3007.JUPITER.2.25  
 3007.JUPITER.11.25  
 3007.JUPITER.14.25

**build-up**  
 60VA - cable 1,5m - curved rod  
 Kabel 1,5m - gekrümmte Stange

**3007.STEP/.. /25 - DISPLAY**

~230V   IP20     0,5 m  05.10.02 



display lighting - clip 25mm - with transformer  
Beleuchtung für Schaufenster - clip 25mm - mit Trafo

**Lamptype**  
 <img alt="QR-CB 51 GU5,3/GX5,3 (1) 50W" data-bbox="350 583 375 598"/> QR-CB 51 GU5,3/GX5,3 (1) 50W 12V

**Dimensions**  
 <img alt="H350xD590" data-bbox="350 613 375 628"/> H350xD590  
 <img alt="L90xB90xH39" data-bbox="350 628 375 643"/> L90xB90xH39

**Ref**  
 3007.STEP.1.25  
 3007.STEP.2.25  
 3007.STEP.11.25  
 3007.STEP.14.25

**build-up**  
 60VA - cable 1,5m - curved rod  
 Kabel 1,5m - gekrümmte Stange

**3008.DISCUS/.. /45 - DISPLAY**

~230V   IP20     0,3787  0,5 m  05.10.02 



display lighting - clip 45mm - with transformer  
Beleuchtung für Schaufenster - clip 45mm - mit Trafo

**Lamptype**  
 <img alt="QR-CB 51 GU5,3/GX5,3 (1) 50W" data-bbox="350 795 375 810"/> QR-CB 51 GU5,3/GX5,3 (1) 50W 12V

**Dimensions**  
 <img alt="H350xD590" data-bbox="350 825 375 840"/> H350xD590  
 <img alt="L90xB90xH39" data-bbox="350 840 375 854"/> L90xB90xH39

**Ref**  
 3008.DISCUS.1.45  
 3008.DISCUS.2.45  
 3008.DISCUS.11.45  
 3008.DISCUS.14.45

**build-up**  
 60VA - cable 1,5m - curved rod  
 Kabel 1,5m - gekrümmte Stange

3008.JUPITER/./45 - DISPLAY

~230V   IP20    0,5 m  



display lighting - clip 45mm - with transformer  
Beleuchtung für Schaufenster - clip 45mm - mit Trafo

Ref

- 3008.JUPITER.1.45
- 3008.JUPITER.2.45
- 3008.JUPITER.11.45
- 3008.JUPITER.14.45

Lamp type

QR-CB 51 GU5,3/GX5,3 (1) 50W 12V

Dimensions

H350xD590

L90xB90xH39

build-up  
60VA - cable 1,5m - curved rod  
Kabel 1,5m - gekrümmte Stange

3008.STEP/./45 - DISPLAY

~230V   IP20    0,1563   



display lighting - clip 45mm - with transformer  
Beleuchtung für Schaufenster - clip 45mm - mit Trafo

Ref

- 3008.STEP.1.45
- 3008.STEP.2.45
- 3008.STEP.11.45
- 3008.STEP.14.45

Lamp type

QR-CB 51 GU5,3/GX5,3 (1) 50W 12V

Dimensions

H350xD590

L90xB90xH39

build-up  
60VA - cable 1,5m - curved rod  
Kabel 1,5m - gekrümmte Stange

1289/.. - FLATFACE

~230V   IP20    2,5800   

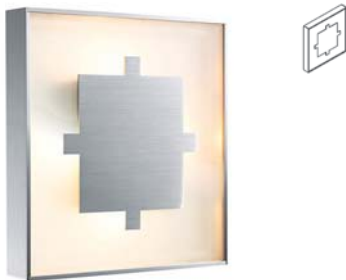

build-up wall light - standard matt white glass - inside square  
140x140 - with transformer  
Wandleuchte für Aufbau - standard Glas Weiß matt - Karree  
innen 140x140 - mit Trafo

Ref

1289.14

Lamp type

QT12 GY6,35 (4) 20W 12V

Dimensions

B270xH270xD35

build-up  
105VA

1606/.. - GENIO

~230V  IP20    0,4500   



build-up wall light  
Wandleuchte für Aufbau

Ref

- 1606.5
- 1606.7
- 1606.14
- 1606.16

Lamp type

QT14 G9 (1) 60W 230V

Dimensions

B200xH200xD82

L120xB120

build-up

1290/.. - FORUM Portable Lamp

~230V   IP20    1,3300 0,5 m 05.10.02 



build-up wall light - directional - standard cable 1m50 with switch - with transformer  
Wandleuchte für Aufbau - schwenkbar - Kabel standard 1,5m mit Schalter - mit Trafo

Ref  
1290.11  
1290.14

Lamptype

QR-CB 51 coolfit GU5,3/GX5,3 (2) 50W 12V

Dimensions

↔ B80xH350xD95

↖ L80xB80



build-up  
105VA - use coolfit lamp  
Coolfit-Lampe verwenden

1291/.. - FORUM Fixed Lamp

~230V   IP20    1,3400 0,5 m 05.10.02 



build-up wall light - directional - with transformer  
Wandleuchte für Aufbau - schwenkbar - mit Trafo

Ref  
1291.11  
1291.14

Lamptype

QR-CB 51 coolfit GU5,3/GX5,3 (2) 50W 12V

Dimensions

↔ B80xH350xD105

↖ Ø69



build-up  
105VA - use coolfit lamp  
Coolfit-Lampe verwenden

1605/.. - GOYA

~230V   IP20   0,5 m 05.10.02 



build-up wall light - with transformer  
Wandleuchte für Aufbau - mit Trafo

Ref  
1605.14

Lamptype

QR-CB 35 GU4/GZ4 (1) 20W 12V

Dimensions

↔ Ø50xH600xD85

↖ B40xH85xD30

build-up  
60VA

4026.W1/.. - GUILIA

~230V  IP20   0,7027 0,5 m 05.10.02 



build-up wall light - with glass  
Wandleuchte für Aufbau - mit Glas

Ref  
4026.W1.13  
4026.W1.14  
4026.W1.16

Lamptype

QT14 G9 (1) 25W 230V

or CFL G9 (1) 7W 230V

Dimensions

↔ B80xH225xD130

↖ L55xB55

Options

R1029/.. - GUILIA A spare glass

build-up

4026.W2/.. - GUILIA

~230V



build-up



build-up wall light - with glass  
Wandleuchte für Aufbau - mit Glas

Lamp type

☐ QT14 G9 (2) 25W 230V  
or ☐ CFL G9 (2) 7W 230V

Dimensions

↔ B190xH225xD130  
⤴ L165xB55

Options

R1029/.. - GUILIA A spare glass

Ref

4026.W2.13  
4026.W2.14  
4026.W2.16

4027.W1/.. - GUILIA

~230V

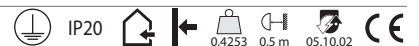

build-up



build-up wall light - with glass  
Wandleuchte für Aufbau - mit Glas

Lamp type

☐ QT14 G9 (1) 25W 230V  
or ☐ CFL G9 (1) 7W 230V

Dimensions

↔ B80xH225xD130  
⤴ L55xB55

Options

R1028/.. - GUILIA B spare glass

Ref

4027.W1.13  
4027.W1.14  
4027.W1.16

4027.W2/.. - GUILIA

~230V



build-up



build-up wall light - with glass  
Wandleuchte für Aufbau - mit Glas

Lamp type

☐ QT14 G9 (2) 25W 230V  
or ☐ CFL G9 (2) 7W 230V

Dimensions

↔ B190xH225xD130  
⤴ L165xB55

Options

R1028/.. - GUILIA B spare glass

Ref

4027.W2.13  
4027.W2.14  
4027.W2.16

4025.W1/.. - MAX

~230V



build-up



build-up wall light - with glass  
Wandleuchte für Aufbau - mit Glas

Lamp type

☐ QT14 G9 (1) 25W 230V  
or ☐ CFL G9 (1) 7W 230V

Dimensions

↔ B80xH255xD130  
⤴ L55xB55

Options

461507/.. - MAX spare glass

Ref

4025.W1.14  
4025.W1.16

4025.W2/.. - MAX

~230V  IP20   1,7505  0,5 m  05.10.02 



build-up wall light - with glass  
Wandleuchte für Aufbau - mit Glas

Ref

4025.W2.14

4025.W2.16

**Lamptype**

 QT14 G9 (2) 25W 230V

or  CFL G9 (2) 7W 230V

**Dimensions**

 B190xH255xD130

 L165xB55

**Options**

461507/.. - MAX spare glass

build-up

1259/.. - HAVANA I

~230V  IP20   0,5000  0,5 m  05.10.02 



build-up wall light - with transformer  
Wandleuchte für Aufbau - mit Trafo

Ref

1259.11

1259.14

**Lamptype**

 QR-CB 51 coolfit GU5,3/GX5,3 (1) 50W 12V

**Dimensions**

 B70xH110xD85

 B60xH85

build-up

60VA - use coolfit lamp

Coolfit-Lampe verwenden

1260/.. - HAVANA I

~12V  IP20   0,2600  0,5 m  05.10.02 



build-up wall light - without transformer  
Wandleuchte für Aufbau - ohne Trafo

Ref

1260.11

1260.14

**Lamptype**

 QR-CB 51 coolfit GU5,3/GX5,3 (1) 50W 12V

**Dimensions**

 B70xH100xD85

 L60xB60

build-up

use coolfit lamp

Coolfit-Lampe verwenden

1261/.. - HAVANA I

~230V  IP20   0,2700  1 m  05.10.02 



build-up wall light  
Wandleuchte für Aufbau

Ref

1261.11

1261.14

**Lamptype**

 QPAR 51 GU10 (1) 50W 230V

**Dimensions**

 B70xH100xD85

 L60xB60

build-up

1262/.. - HAVANA II

~12V 0,4000 0,5 m 05.10.02



build-up wall light - without transformer  
Wandleuchte für Aufbau - ohne Trafo

Ref

1262.11

**Lamptype**

QR-CB 51 coolfit GU5,3/GX5,3 (2) 50W 12V

1262.14

**Dimensions**

B130xH100xD85

L60xB60

build-up  
use coolfit lamp  
Coolfit-Lampe verwenden

1263/.. - HAVANA II

~230V IP20 0,4000 1 m 05.10.02



build-up wall light  
Wandleuchte für Aufbau

Ref

1263.11

**Lamptype**

QPAR 51 GU10 (2) 50W 230V

1263.14

**Dimensions**

B130xH100xD85

L60xB60

build-up

1266/.. - HAVANA MIRROR

~12V 0,7100 0,5 m 05.10.02



build-up wall light - without transformer  
Wandleuchte für Aufbau - ohne Trafo

Ref

1266.11

**Lamptype**

QR-CB 51 coolfit GU5,3/GX5,3 (2) 50W 12V

1266.14

**Dimensions**

B130xH225xD85

L60xB60

build-up  
use coolfit lamp  
Coolfit-Lampe verwenden

1267/.. - HAVANA MIRROR

~230V IP20 0,7000 1 m 05.10.02



build-up wall light  
Wandleuchte für Aufbau

Ref

1267.11

**Lamptype**

QPAR 51 GU10 (2) 50W 230V

1267.14

**Dimensions**

B130xH225xD85

L60xB60

build-up

4024/.. - KOBUS

~230V IP20 0,1725 1 m 05.10.02



build-up wall light - choice between brown glass (BR) with white curved stripes or complete in alu without glass  
Wandleuchte für Aufbau - Wahl zwischen braunem Glas (BR) mit weißen gekrümmten Linien oder ganz in Alu ohne Glas

Ref  
4024.BR.14  
4024.14

Lamptype

QT14 G9 (1) 25W 230V  
or CFL G9 (1) 7W 230V

Dimensions

B100xH70xD125  
L60xB60

build-up

1600/.. - LARA

~230V IP20 0,1725 1 m 05.10.02



build-up wall light - with glass  
Wandleuchte für Aufbau - mit Glas

Ref  
1600.7  
1600.14

Lamptype

QT14 G9 (1) 25W 230V

Dimensions

B80xH80xD80  
L80xB80

build-up

1602/.. - LARA

~230V IP20 0,8750 1 m 05.10.02



build-up wall light - with glass  
Wandleuchte für Aufbau - mit Glas

Ref  
1602.7  
1602.14

Lamptype

QT14 G9 (2) 25W 230V

Dimensions

B180xH80xD80  
L180xB80

build-up

3036/.. - LOFT

~230V IP20 0,5075 0,5 m 05.10.02



build-up wall light - with transformer  
Wandleuchte für Aufbau - mit Trafo

Ref  
3036.11S  
3036.14

Lamptype

QR-CB 51 coolfit GU5,3/GX5,3 (1) 50W 12V

Dimensions

B80xH170xD145  
B40xH158xD32

build-up  
60VA - use coolfit lamp  
Coolfit-Lampe verwenden



3017/.. - LOLA

~230V  IP44    0,1950  0,5 m  05.10.50 



build-up wall light - with electronic gear  
Wandleuchte für Aufbau - mit elektronischem Vorschaltgerät

Ref

3017.7  
3017.14  
3017.40

Lamp type

TC-DEL G24Q2 (1) 18W 230V

Dimensions

B80xH210xD105  
L80xB80

build-up

1400/.. - LOTUS UP

~230V  IP20    2,1800  1 m  05.10.02 



build-up wall light  
Wandleuchte für Aufbau

Ref

1400.10

Lamp type

QT-DE 12 74,9mm R7s (1) 100W 230V

Dimensions

B210xH210xD160  
L170xB170

build-up

1401/.. - LOTUS UP

~230V  IP20    2,7950  1 m  05.10.02 



build-up wall light  
Wandleuchte für Aufbau

Ref

1401.10

Lamp type

QT-DE 12 74,9mm R7s (1) 150W 230V

Dimensions

B200xH300xD160  
B170xH260

build-up

1402/.. - LOTUS UP

~230V  IP20    3,5900  1 m  05.10.02 



build-up wall light  
Wandleuchte für Aufbau

Ref

1402.10

Lamp type

QT-DE 12 114,1mm R7s (1) 200W 230V

Dimensions

B300xH300xD160  
L260xB260

build-up

3002A/.. - LUCIFER

~230V



build-up wall light  
Wandleuchte für Aufbau

Ref

3002A.40

Lamptype

— QT-DE 12 74,9mm R7s (1) 150W 230V

Dimensions

↔ B180xH110xD140

⌞ L180xB35

build-up

3002B/.. - LUCIFER

~230V



build-up wall light  
Wandleuchte für Aufbau

Ref

3002B.40

Lamptype

— QT-DE 12 114,1mm R7s (1) 200W 230V

Dimensions

↔ B220xH110xD140

⌞ L220xB35

build-up

3030/.. - MAMBO

~230V

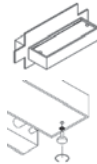

build-up wall light - up & down  
Wandleuchte für Aufbau - up & down

Ref

3030.11

Lamptype

— QT-DE 12 114,1mm R7s (1) 200W 230V

3030.14

Dimensions

↔ B325xH135xD138

3030.16

⌞ L235xB45

build-up  
do not screw on too tightly  
nicht zu fest verschrauben

3031/.. - MAMBO

~230V



build-up wall light - up & down - with magnetic gear  
Wandleuchte für Aufbau - up & down - mit magnetischem  
Vorschaltgerät

Ref

3031.11

Lamptype

← TC-D G24D-3 (1) 26W 230V

3031.14

Dimensions

↔ B325xH135xD138

3031.16

⌞ L235xB45

build-up  
do not screw on too tightly  
nicht zu fest verschrauben

3032/.. - MAMBO

~230V

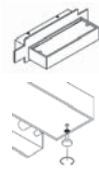

build-up wall light - up & down  
Wandleuchte für Aufbau - up & down

Ref

3032.11

Lamp type

— QT-DE 12 114,1mm R7s (1) 200W 230V

3032.14

Dimensions

↔ B325xH90xD138

3032.16

⌞ L235xB45

*build-up*  
do not screw on too tightly  
nicht zu fest verschrauben

3033/.. - MAMBO

~230V

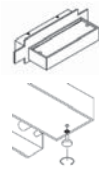

build-up wall light - up & down - with magnetic gear  
Wandleuchte für Aufbau - up & down - mit magnetischem  
Vorschaltgerät

Ref

3033.11

Lamp type

← TC-D G24D-3 (1) 26W 230V

3033.14

Dimensions

↔ B325xH90xD138

3033.16

⌞ L235xB45

*build-up*  
do not screw on too tightly  
nicht zu fest verschrauben

3034/.. - MAMBO

~230V

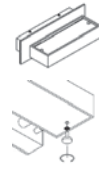

build-up wall light - up & down  
Wandleuchte für Aufbau - up & down

Ref

3034.11

Lamp type

— QT-DE 12 114,1mm R7s (1) 200W 230V

3034.14

Dimensions

↔ B285xH90xD135

3034.16

⌞ L235xB45

*build-up*  
do not screw on too tightly  
nicht zu fest verschrauben

3035/.. - MAMBO

~230V



build-up wall light - up & down - with magnetic gear  
Wandleuchte für Aufbau - up & down - mit magnetischem  
Vorschaltgerät

Ref

3035.11

Lamp type

← TC-D G24D-3 (1) 26W 230V

3035.14

Dimensions

↔ B285xH90xD135

3035.16

⌞ L235xB45

*build-up*  
do not screw on too tightly  
nicht zu fest verschrauben

3050/.. - MAMBO

~230V

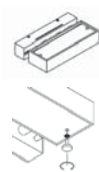

build-up wall light - up & down  
Wandleuchte für Aufbau - up & down

Lamp type

— QT-DE 12 114,1mm R7s (1) 200W 230V

Dimensions

↔ B235xH45xD135

⌞ L235xB45

Ref

3050.11

3050.14

3050.16

**build-up**  
do not screw on too tightly  
nicht zu fest verschrauben

3051/.. - MAMBO

~230V



build-up wall light - up & down - with magnetic gear  
Wandleuchte für Aufbau - up & down - mit magnetischem  
Vorschaltgerät

Lamp type

↔ TC-D G24D-3 (1) 26W 230V

Dimensions

↔ B235xH45xD135

⌞ L235xB45

Ref

3051.11

3051.14

3051.16

**build-up**  
do not screw on too tightly  
nicht zu fest verschrauben

3052/.. - MAMBO

~230V



ceiling light  
Deckenleuchte

Lamp type

— QT-DE 12 114,1mm R7s (1) 150W 230V

Dimensions

↔ L220xB80xH105

⌞ L220xB40xH50

Ref

3052.2

3052.11

3052.14

**build-up**  
do not screw on too tightly  
nicht zu fest verschrauben

3053/.. - MAMBO

~230V



ceiling light - with magnetic gear  
Deckenleuchte - mit magnetischem Vorschaltgerät

Lamp type

↔ TC-D G24D-3 (1) 26W 230V

Dimensions

↔ L250xB80xH137

⌞ L250xB50xH50

Ref







3053.2



3053.11

3053.14

**build-up**  
do not screw on too tightly  
nicht zu fest verschrauben

LED colours: cold white (CW) or warm white (WW) - other LED colours on request  
 LED Farben: kalt Weiß (CW) oder warm Weiß (WW) - andere LED Farben auf Anfrage



**3028/.. - MAMBO LED** ~230V  IP20    0,0938  05.10.02 







build-up wall light - down  
 Wandleuchte für Aufbau - down



**Ref**  
 3028.1M.CW  
 3028.1M.WW  
 3028.10.CW  
 3028.10.WW  
 3028.14.CW  
 3028.14.WW  
 3028.22.CW  
 3028.22.WW

**Lamptype**  
 led 230V . (2) 3W 230V

**Dimensions**  
 B200xH35xD80  
 L200xB35

build-up



**3029/.. - MAMBO LED** ~230V  IP20    0,0938  05.10.02 







build-up wall light - up & down  
 Wandleuchte für Aufbau - up & down



**Ref**  
 3029.1M.CW  
 3029.1M.WW  
 3029.10.CW  
 3029.10.WW  
 3029.14.CW  
 3029.14.WW  
 3029.22.CW  
 3029.22.WW

**Lamptype**  
 led 230V . (3) 3W 230V

**Dimensions**  
 B200xH35xD80  
 L200xB35

build-up



**3043/.. - MICRO** ~230V  IP20    0,5333  0,5 m  05.10.02 







build-up wall light - with transformer  
 Wandleuchte für Aufbau - mit Trafo



**Ref**  
 3043.7  
 3043.11  
 3043.14

**Lamptype**  
 QR-CB 51 coolfit GU5,3/GX5,3 (1) 35W 12V

**Dimensions**  
 B60xH60xD121  
 L60xB60

build-up  
 60VA - use coolfit lamp  
 Coolfit-Lampe verwenden



**3042/..T1 - NEMO** ~230V  IP20    0,4400  0,5 m  05.10.02 

build-up wall light - T1 polycarbonate - with transformer  
 Wandleuchte für Aufbau - T1 Polykarbonat - mit Trafo

**Ref**  
 3042.14.T1

**Lamptype**  
 QT12 GY6,35 (1) 50W 12V

**Dimensions**  
 B60xH150xD75  
 Ø60xH56

build-up  
 60VA

3042/..T2 - NEMO

~230V



build-up wall light - T2 alu + polycarbonate - with transformer  
Wandleuchte für Aufbau - T2 Alu + Polykarbonat - mit Trafo

Ref

3042.14.T2

Lamptype

QT12 GY6,35 (1) 50W 12V

Dimensions

B60xH150xD75

Ø60xH56

build-up  
60VA

3042/..T3 - NEMO

~230V



build-up wall light - T3 alu - with transformer  
Wandleuchte für Aufbau - T3 Alu - mit Trafo

Ref

3042.14.T3

Lamptype

QR-CB 51 coolfit GU5,3/GX5,3 (1) 35W 12V

Dimensions

B60xH150xD75

Ø60xH56

build-up  
60VA - use coolfit lamp  
Coolfit-Lampe verwenden

641.HL105/.. - MONET

~230V

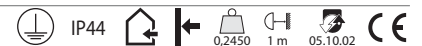

build-up wall light - stainless steel housing + polycarbonate cover  
Wandleuchte für Aufbau - Gehäuse in Edelstahl + Deckel in Polykarbonat

Ref

641.HL105.1M

641.HL105.5

Lamptype

TC-FSE GX53 (1) 6W 230V

Dimensions

B104xH55xD120

build-up

641.HL335/.. - MONET

~230V

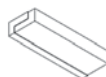

build-up wall light - stainless steel housing + polycarbonate cover - with magnetic gear  
Wandleuchte für Aufbau - Gehäuse in Edelstahl + Deckel in Polykarbonat - mit magnetischem Vorschaltgerät

Ref

641.HL335.1M

641.HL335.5

Lamptype

TC-S G23 (1) 11W 230V

Dimensions

B335xH55xD94

build-up

641.HL600/.. - MONET

~230V

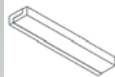

build-up wall light - stainless steel housing + polycarbonate cover - with electronic gear  
Wandleuchte für Aufbau - Gehäuse in Edelstahl + Deckel in Polykarbonat - mit elektronischem Vorschaltgerät

Ref

641.HL600.1M  
641.HL600.5

Lamp type

⇒ T16FQ T5 G5 (1) 24W 230V

Dimensions

↔ B604xH55xD94

build-up

641.SL335/.. - MONET STRIP

~230V



build-up ceiling or wall light - stainless steel housing + polycarbonate cover - with magnetic gear  
Decken- oder Wandleuchte für Aufbau - Gehäuse in Edelstahl + Deckel in Polykarbonat - mit magnetischem Vorschaltgerät

Ref

641.SL335.1M  
641.SL335.5

Lamp type

← TC-S G23 (1) 11W 230V

Dimensions

↔ L335xB55xH95

build-up

641.SL600/.. - MONET STRIP

~230V



build-up ceiling or wall light - stainless steel housing + polycarbonate cover - with electronic gear  
Decken- oder Wandleuchte für Aufbau - Gehäuse in Edelstahl + Deckel in Polykarbonat - mit elektronischem Vorschaltgerät

Ref

641.SL600.1M  
641.SL600.5

Lamp type

⇒ T16FQ T5 G5 (1) 24W 230V

Dimensions

↔ L605xB55xH95

build-up

641.VL105/.. - MONET

~230V

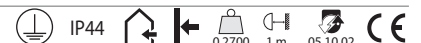

build-up wall light - stainless steel housing + polycarbonate cover  
Wandleuchte für Aufbau - Gehäuse in Edelstahl + Deckel in Polykarbonat

Ref

641.VL105.1M  
641.VL105.5

Lamp type

⊘ TC-FSE GX53 (1) 6W 230V

Dimensions

↔ B104xH120xD55

build-up

641.VL335/.. - MONET

~230V



build-up wall light - stainless steel housing + polycarbonate cover - with magnetic gear  
Wandleuchte für Aufbau - Gehäuse in Edelstahl + Deckel in Polykarbonat - mit magnetischem Vorschaltgerät

Ref

641.VL335.1M

641.VL335.5

Lamp type

← TC-S G23 (1) 11W 230V

Dimensions

↔ B335xH94xD55

build-up

641.VL600/.. - MONET

~230V



build-up wall light - stainless steel housing + polycarbonate cover - with electronic gear  
Wandleuchte für Aufbau - Gehäuse in Edelstahl + Deckel in Polykarbonat - mit elektronischem Vorschaltgerät

Ref

641.VL600.1M

641.VL600.5

Lamp type

→ T16FQ T5 G5 (1) 24W 230V

Dimensions

↔ B604xH94xD55

build-up

646.1200/.. - STRIPE

~230V



build-up ceiling or wall light - with electronic gear  
Decken- oder Wandleuchte für Aufbau - mit elektronischem Vorschaltgerät

Ref

646.1200.1M

646.1200.10

646.1200.14

Lamp type

↔ T16-S HO T5 G5 (1) 54W 230V

Dimensions

↔ L1200xB40xH70

↕ L1190xB36

build-up

646.600/.. - STRIPE

~230V



build-up ceiling or wall light - with electronic gear  
Decken- oder Wandleuchte für Aufbau - mit elektronischem Vorschaltgerät

Ref

646.600.1M

646.600.10

646.600.14

Lamp type

↔ T16-S HO T5 G5 (1) 24W 230V

Dimensions

↔ L580xB40xH70

↕ L574xB36

build-up



646.900/.. - STRIPE

~230V   IP20    05.10.50 



build-up ceiling or wall light - with electronic gear  
Decken- oder Wandleuchte für Aufbau - mit elektronischem Vorschaltgerät

**Ref**  
646.900.1M  
646.900.10  
646.900.14

**Lamp type**  
T16-S HO T5 G5 (1) 39W 230V

**Dimensions**  
L900xB40xH70  
L890xB36

build-up

3001/.. - SWING

~230V   IP20    0,8600  0,5 m  05.10.02 



build-up wall light - with transformer  
Wandleuchte für Aufbau - mit Trafo

**Ref**  
3001.1  
3001.2  
3001.4  
3001.7  
3001.11  
3001.13  
3001.14  
3001.16

**Lamp type**  
QR-CB 51 coolfit GU5,3/GX5,3 (2) 35W 12V

**Dimensions**  
L245xB110xH130-180  
L110xB110

build-up  
105VA - use coolfit lamp  
Coolfit-Lampe verwenden

4018/.. - NOA glass + alu

~230V   IP20    1,1330  0,5 m  05.10.02 



build-up wall light - with glass - with transformer  
Wandleuchte für Aufbau - mit Glas - mit Trafo

**Ref**  
4018.14  
4018.16

**Lamp type**  
QR-CB 51 coolfit GU5,3/GX5,3 (1) 50W 12V

**Dimensions**  
Ø60xH350xD140  
Ø60

build-up  
60VA - use coolfit lamp  
Coolfit-Lampe verwenden

4023/.. - NOA glass + alu

~230V  IP20    1,0650  0,5 m  05.10.50 



build-up wall light - with glass  
Wandleuchte für Aufbau - mit Glas

**Ref**  
4023.14  
4023.16

**Lamp type**  
TC-DEL G24Q2 (1) 18W 230V

**Dimensions**  
Ø60xH350xD140  
Ø60

build-up

4020/.. - NOA PC

~230V



build-up wall light - polycarbonate  
Wandleuchte für Aufbau - Polykarbonat

Ref

4020.14

Lamptype

mini lynx longlife E27 (1) 11W 230V

4020.16

Dimensions

Ø60xH350xD140

Ø60

build-up

4022/.. - NOA PC

~230V



build-up wall light - polycarbonate - with transformer  
Wandleuchte für Aufbau - Polykarbonat - mit Trafo

Ref

4022.14

Lamptype

QR-CB 51 coolfit GU5,3/GX5,3 (1) 35W 12V

4022.16

Dimensions

Ø60xH350xD140

Ø60

build-up

60VA - use coolfit lamp  
Coolfit-Lampe verwenden

1272/.. - PAVO

~12V



build-up wall light - without transformer  
Wandleuchte für Aufbau - ohne Trafo

Ref

1272.14

Lamptype

QR-CB 51 coolfit GU5,3/GX5,3 (1) 50W 12V

Dimensions

B62xH115xD85

L62xB85

build-up

use coolfit lamp  
Coolfit-Lampe verwenden

1273/.. - PAVO

~230V



build-up wall light  
Wandleuchte für Aufbau

Ref

1273.14

Lamptype

QPAR 51 GU10 (1) 50W 230V

Dimensions

B62xH115xD85

L62xB85

build-up

1250/.. - OUTSIDER

~12V 0,4300 0,5 m 05.10.02



build-up wall light - without transformer  
Wandleuchte für Aufbau - ohne Trafo

Ref  
1250.36

**Lamptype**

QT12 GY6,35 (1) 50W 12V

**Dimensions**

B100xH100xD38

build-up

1250/.. /C - OUTSIDER

~12V 0,4300 0,5 m 05.10.02



build-up wall light - without transformer  
Wandleuchte für Aufbau - ohne Trafo

Ref  
1250.36.C

**Lamptype**

QT12 GY6,35 (1) 50W 12V

**Dimensions**

B100xH100xD38

build-up

3040/.. - RAYA

~230V IP20 1,2600 1 m 05.10.02



build-up wall light  
Wandleuchte für Aufbau

Ref  
3040.40

**Lamptype**

QT-DE 12 74,9mm R7s (1) 100W 230V

**Dimensions**

B120xH180xD60

build-up

3041/.. - RAYA MINI

~230V IP20 0,6150 1 m 05.10.02



build-up wall light  
Wandleuchte für Aufbau

Ref  
3041.40

**Lamptype**

QPAR 51 GU10 (1) 50W 230V

**Dimensions**

B100xH100xD80

build-up



1269/.. - SURF

~230V   IP20    0,6400  0,5 m  05.10.02 



build-up wall light - with transformer  
Wandleuchte für Aufbau - mit Trafo

Ref  
1269.14

Lamptype

 QR-CB 51 coolfit GU5,3/GX5,3 (1) 50W 12V

Dimensions

 B100xH120xD105

 B60xH100

build-up  
60VA - use coolfit lamp  
Coolfit-Lampe verwenden

1270/.. - SURF

~12V   IP20    0,4400  0,5 m  05.10.02 



build-up wall light - without transformer  
Wandleuchte für Aufbau - ohne Trafo

Ref  
1270.14

Lamptype

 QR-CB 51 coolfit GU5,3/GX5,3 (1) 50W 12V

Dimensions

 B100xH120xD105

 B60xH60

build-up  
use coolfit lamp  
Coolfit-Lampe verwenden

1271.ES63/.. - SURF

~230V  IP20    0,5000  1 m  05.10.02 



build-up wall light  
Wandleuchte für Aufbau

Ref  
1271.ES63.40

Lamptype

 QPAR64 GU10 (1) 75W 230V

Dimensions

 B100xH120xD105

 L60xB60

build-up

1271/.. - SURF

~230V  IP20    0,4500  1 m  05.10.02 



build-up wall light  
Wandleuchte für Aufbau

Ref  
1271.14

Lamptype

 QPAR 51 GU10 (1) 50W 230V

Dimensions

 B100xH120xD105

 L60xB60

build-up

3010/.. - VITO

~12V



build-up wall light - up or down - without transformer  
Wandleuchte für Aufbau - up oder down - ohne Trafo

Ref

Lamptype

QR-CB 51 coolfit GU5,3/GX5,3 (1) 50W 12V

Dimensions

Ø55xH125xD100

B40xH55

- 3010.1
- 3010.2
- 3010.7
- 3010.11
- 3010.13
- 3010.14
- 3010.16

build-up  
use coolfit lamp  
Coolfit-Lampe verwenden

3011/.. - VITO

~230V



build-up wall light - up or down - with transformer  
Wandleuchte für Aufbau - up oder down - mit Trafo

Ref

Lamptype

QR-CB 51 coolfit GU5,3/GX5,3 (1) 35W 12V

Dimensions

Ø55xH125xD100

B40xH117

- 3011.1
- 3011.2
- 3011.7
- 3011.11
- 3011.13
- 3011.14
- 3011.16

build-up  
60VA - use coolfit lamp  
Coolfit-Lampe verwenden

3012/.. - VITO

~12V



build-up wall light - up & down - without transformer  
Wandleuchte für Aufbau - up & down - ohne Trafo

Ref

Lamptype

QR-CB 51 coolfit GU5,3/GX5,3 (2) 50W 12V

Dimensions

Ø55xH150xD100

B40xH55

- 3012.1
- 3012.2
- 3012.7
- 3012.11
- 3012.13
- 3012.14
- 3012.16

build-up  
use coolfit lamp  
Coolfit-Lampe verwenden

3013/.. - VITO

~230V



build-up wall light - up & down - with transformer  
Wandleuchte für Aufbau - up & down - mit Trafo

Ref

Lamptype

QR-CB 51 coolfit GU5,3/GX5,3 (2) 20W 12V

Dimensions

Ø55xH150xD100

B40xH117

- 3013.1
- 3013.2
- 3013.7
- 3013.11
- 3013.13
- 3013.14
- 3013.16

build-up  
60VA - use coolfit lamp  
Coolfit-Lampe verwenden

3076/.. - TOLEDO WALL

~230V  IP20    0.5 m  05.10.02 



build-up wall light - with mounting bracket at the back  
Wandleuchte für Aufbau - mit Befestigungsbügel hinten

Ref

Lamptype

⊙ TC-FSE GX53 (1) 9W 230V

3076.1M

3076.7

3076.14

Dimensions

↔ B90xH30xD120

⌞ L90xB30

build-up  
CFL GX53 4W on request  
auf Anfrage

3076B/.. - TOLEDO WALL

~230V  IP20    0.5 m  05.10.02 



build-up wall light - stainless steel fixation on top!  
Wandleuchte für Aufbau - Befestigung in Edelstahl oben!

Ref

Lamptype

⊙ TC-FSE GX53 (1) 9W 230V

3076B.1M

3076B.5

Dimensions

↔ B90xH27xD125

⌞ L125xB90

build-up  
for application in kitchen and bathroom closets  
für Anwendung in Badezimmer- & Küchenschranken

1280/.. - ZEN 50

~230V  IP20    0,5300  1 m  05.10.02 



build-up wall light  
Wandleuchte für Aufbau

Ref

Lamptype

⊙ QPAR 51 GU10 (1) 50W 230V

1280.40

Dimensions

↔ B60xH285xD60

build-up

1281/.. - ZEN 100

~230V  IP20    2,2500  1 m  05.10.02 



build-up wall light  
Wandleuchte für Aufbau

Ref

Lamptype

— QT-DE 12 114,1mm R7s (1) 100W 230V

1281.40

Dimensions

↔ B160xH285xD60

build-up

1282/.. - ZEN pl26

~230V



build-up wall light - with magnetic gear  
Wandleuchte für Aufbau - mit magnetischem Vorschaltgerät

Ref

1282.40

Lamp type

TC-D G24D-3 (1) 26W 230V

Dimensions

B210xH285xD60

build-up

1294/.. /B - XENON

~230V

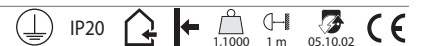

build-up wall light - with blue glass  
Wandleuchte für Aufbau - mit blauem Glas

Ref

1294.40.B

Lamp type

QT14 G9 (1) 40W 230V

Dimensions

B200xH200xD50

L150xB150

build-up

1294/.. /W - XENON

~230V

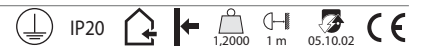

build-up wall light - with opal white glass  
Wandleuchte für Aufbau - mit opalweißem Glas

Ref

1294.40.W

Lamp type

QT14 G9 (1) 40W 230V

Dimensions

B200xH200xD50

L150xB150

build-up

1500/.. - WAVE

~230V



build-up wall light - with electronic gear  
Wandleuchte für Aufbau - mit elektronischem Vorschaltgerät

Ref

1500

Lamp type

T16FHT5 G5 (4) 14W 230V

Dimensions

B600xH600xD112

build-up  
with LED on request  
mit LED auf Anfrage



INDOOR | Led

**ZIA LED**

ZIALED/.. P.366



**ZIAMINI LED**

ZIAMINILED/.. P.366



**ZIAMINI LED**

ZIAMINI.C.LED/.. P.367



**FELIX**

1370/.. P.368



**FELIX**

W1376/.. P.370



**TUCAN**

3103/.. P.371



**TUCAN**

W3106/.. P.372



**SCOTT**

W3083B/.. P.375



**SCOTT**

W3083C/.. P.375



**SCOTT**

W3084.25/.. P.375



**EXIT**

3056/.. P.377



**EXIT**

3057/.. P.377



**DOTS**

3054/.. P.378



**LED PRISMA**

3055/.. P.378



**MIRO**

1230.LED/.. P.401



**CESAR**

1356/..S1 P.382



**CESAR**

W1358/..S1 P.389



**OSCAR**

1344/..S1 P.393



**OSCAR**

1345/..S1 P.395



**SUN LED**

1240.LED/.. P.400



**MOON LED**

1244.LED/.. P.397



**TRIPLE MOON**

1246.LED/..GL P.398



**PRADO**

3058/.. P.401



**PICTO**

1663/.. P.427



**STONE LED**

W1218A/.. P.425



**MIA**

1630/.. P.404



**MIA X**

1634.230V/.. P.406



**BRUNA**

1635.230V/.. P.408



**BRUNA**

1636.230V/.. P.410



**DRIVER**

P.412-417

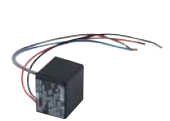

**ECHO**

3086/.. P.418



**FUNGO**

W2400/..4LED P.419



**FOYER**

3096.ZT/.. P.420



**BOLERO LED**

W1097.LED/.. P.424



**MAMBO LED**

3029/.. P.426

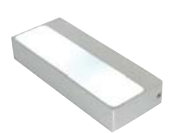

**UNO**

3081.10/.. P.421



**DUO**

3082.10/.. P.421



**PLUTO**

3077/..40 P.423



**ORKA**

3022C/.. P.431



**ORKA**

3089/.. P.433





BOLERO LED	424
BRUNA voor frame bticino	408, 411
CESAR	379 - 382, 388, 389, 391, 392
CESAR X	382 - 388, 390, 391
DOTS - GEARER14PU06/..	378
DRIVER	412 - 417
DUO	421, 422
ECHO - ECHO SQ	418
EXIT - GEARER15PU04/..	377
FELIX	368, 369, 370
FOYER	420
FUNGO	419
LED PRISMA - GEARER14PU06/..	378
MAMBO LED	426
MIA	403, 404, 405
MIA X- voor niko afdekkader	406, 407
MIRO	401
MOON - MOON + GLASS	399
ORKA	430 - 433
OSCAR	393, 394, 395
OSCAR X	395, 396
PICTO - PICTO SENSOR	427, 428, 429
PLUTO	423
PRADO	401, 402
SCOTT - SCOTT CARREE	374, 375, 376
SINGLE MOON - SINGLE MOON + GLASS	397
STONE LED	425
SUN - SUN + GLASS	400
TRIPLE MOON - TRIPLE MOON + GLASS	398
TUCAN	371, 372, 373
UNO	421
ZIALED/..	366
ZIALED.230V/..	366
ZIAMINI.C.LED/..	367
ZIAMINILED/..	366

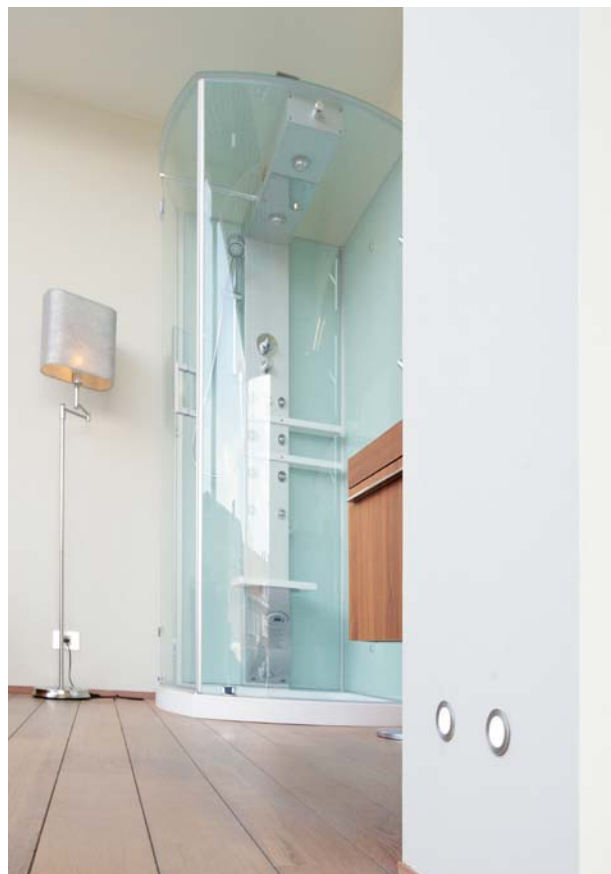

## INDOOR | Led | Ø29 | Ø48

LED colours: cold white (CW) warm white (WW) or blue (B) - other LED colours on request  
LED Farben: kalt Weiß (CW) warm Weiß (WW) oder Blau (B) - andere LED Farben auf Anfrage

### ZIAMINILED/.. - Ø29

=350mA



build-in ceiling and wall light - without LED driver  
Decken- und Wandleuchte für Einbau - ohne Driver LED

#### Lamptype

powered 350mA . (1) 1W 350mA

#### Dimensions

Ø38xH16

Ø29 16

#### Options

S6.30/.. - PLASTERKIT

#### Ref

ZIAMINILED.1.CW

ZIAMINILED.1.B

ZIAMINILED.7.CW

ZIAMINILED.7.B

ZIAMINILED.11.CW

ZIAMINILED.11.B

ZIAMINILED.13.CW

ZIAMINILED.13.B

ZIAMINILED.14.CW

ZIAMINILED.14.B

ZIAMINILED.16.CW

ZIAMINILED.16.B

ZIAMINILED.36.CW

ZIAMINILED.36.B

build-in  
colour 36 IP44  
Farbe 36 IP44

### ZIALED.230V/.. - Ø48

~230V



build-in ceiling and wall light  
Decken- und Wandleuchte für Einbau

#### Lamptype

3 led 230V . (1) 4,8VA 230V

#### Dimensions

Ø58,5xH64

Ø48 74

#### Options

S6.50/.. - PLASTERKIT

#### Ref

ZIALED.230V.14.CW

ZIALED.230V.14.B

ZIALED.230V.37.CW

ZIALED.230V.37.B

build-in

### ZIALED/.. - Ø48

=350mA



build-in ceiling and wall light - without LED driver  
Decken- und Wandleuchte für Einbau - ohne Driver LED

#### Lamptype

powered 350mA . (1) 1W 350mA

#### Dimensions

Ø58,5xH64

Ø48 74

#### Options

S6.50/.. - PLASTERKIT

#### Ref

ZIALED.14.CW

ZIALED.14.WW

ZIALED.14.B

ZIALED.37.CW

ZIALED.37.WW

ZIALED.37.B

build-in  
clear glass + reflector on request  
helles Glas + Reflektor auf Anfrage

LED colours: cold white (CW) warm white (WW) or blue (B) - other LED colours on request  
 LED Farben: kalt Weiß (CW) warm Weiß (WW) oder Blau (B) - andere LED Farben auf Anfrage

**ZIAMINI.C.LED/.. - Ø29**

=350mA



build-in ceiling and wall light - without LED driver  
 Decken- und Wandleuchte für Einbau - ohne Driver LED

**Lamptype**

powered 350mA . (1) 1W 350mA

**Dimensions**

L40xB40xH16

Ø29 16

**Options**

S6.30/.. - PLASTERKIT

**Ref**

- ZIAMINI.C.LED.1.CW
- ZIAMINI.C.LED.1.B
- ZIAMINI.C.LED.7.CW
- ZIAMINI.C.LED.7.B
- ZIAMINI.C.LED.11.CW
- ZIAMINI.C.LED.11.B
- ZIAMINI.C.LED.13.CW
- ZIAMINI.C.LED.13.B
- ZIAMINI.C.LED.14.CW
- ZIAMINI.C.LED.14.B
- ZIAMINI.C.LED.16.CW
- ZIAMINI.C.LED.16.B
- ZIAMINI.C.LED.36.CW
- ZIAMINI.C.LED.36.B

build-in  
 colour 36 IP44  
 Farbe 36 IP44



LED indoor

## INDOOR | Led | FELIX

downlights for verandas and pergolas - LED colour: naturel white (NW) - other LED colours on demand

Einbaustrahler für Veranden und Pergolen - LED Farbe: naturell Weiß (NW) - andere LED Farben auf Anfrage

### 1370/.. - FELIX

=700mA



S1

IP44



0,0450

0,5

05.10.02



downlight for veranda profiles - without LED driver  
Einbaustrahler für Verandaprofilen - ohne Driver LED

#### Lamptype

powered 700mA . (1) 3W 700mA

#### Dimensions

Ø44xH38 40° reflector

Ø40 50

#### Ref

1370.1M.NW

1370.14.NW

1370.24.NW

1370.40.NW

#### build-in

other °angle reflector on demand  
andere °Winkel Reflektor auf Anfrage

### 1371/.. - FELIX

=700mA



S1

IP44



0,5

05.10.02



downlight for veranda profiles - with optical lens in  
aluminium housing - without LED driver  
Einbaustrahler für Verandaprofilen - mit optischer Linse in  
einem aluminium Gehäuse - ohne Driver LED

#### Lamptype

powered 700mA . (1) 3W 700mA

#### Dimensions

Ø44xH42 40° reflector

Ø40 56

#### Ref

1371.1M.NW

1371.14.NW

1371.24.NW

1371.40.NW

#### build-in

other °angle reflector on demand  
andere °Winkel Reflektor auf Anfrage

### 1372/.. - FELIX

=700mA



S1

IP44



0,5

05.10.02



downlight for veranda profiles - with optical lens in plexi  
housing - without LED driver  
Einbaustrahler für Verandaprofilen - mit optischer Linse in  
einem plexi Gehäuse - ohne Driver LED

#### Lamptype

powered 700mA . (1) 3W 700mA

#### Dimensions

Ø44xH44 40° reflector

Ø40 58

#### Ref

1372.1M.NW

1372.14.NW

1372.24.NW

1372.40.NW

#### build-in

other °angle reflector on demand - IP54 with closed  
plexi on request  
andere °Winkel Reflektor auf Anfrage - IP54 mit  
geschlossenem Plexi auf Anfrage

### 1374/.. - FELIX

=700mA



S1

IP44



0,0275

0,5

05.10.02



downlight for veranda profiles - without LED driver  
Einbaustrahler für Verandaprofilen - ohne Driver LED

#### Lamptype

powered 700mA . (1) 3W 700mA

#### Dimensions

L44xB44xH38 40° reflector

Ø40 50

#### Ref

1374.1M.NW

1374.14.NW

1374.24.NW

1374.40.NW

#### build-in

other °angle reflector on demand  
andere °Winkel Reflektor auf Anfrage

downlights for verandas and pergolas - LED colour: naturel white (NW) - other LED colours on demand  
 Einbaustrahler für Veranden und Pergolen - LED Farbe: naturell Weiß (NW) - andere LED Farben auf Anfrage

**1375/.. - FELIX**

=700mA IP44



downlight for veranda profiles - with optical lens in aluminium housing - without LED driver  
 Einbaustrahler für Verandaprofilen - mit optischer Linse in einem aluminium Gehäuse - ohne Driver LED

Ref
1375.1M.NW
1375.14.NW
1375.24.NW
1375.40.NW

Lamptype	700mA
powered 700mA . (1) 3W	

Dimensions
L44xB44xH42  40° reflector
Ø40  56

**build-in**  
 other °angle reflector on demand  
 andere °Winkel Reflektor auf Anfrage

**1376/.. - FELIX**

=700mA IP44



downlight for veranda profiles - with optical lens in plexi housing - without LED driver  
 Einbaustrahler für Verandaprofilen - mit optischer Linse in einem plexi Gehäuse - ohne Driver LED

Ref
1376.1M.NW
1376.14.NW
1376.24.NW
1376.40.NW

Lamptype	700mA
powered 700mA . (1) 3W	

Dimensions
L44xB44xH44  40° reflector
Ø40  58

**build-in**  
 other °angle reflector on demand - IP54 with closed plexi on request  
 andere °Winkel Reflektor auf Anfrage - IP54 mit geschlossenem Plexi auf Anfrage

**W1370/.. - FELIX**

=700mA IP44



downlight for veranda profiles - without LED driver  
 Einbaustrahler für Verandaprofilen - ohne Driver LED

Ref
W1370.31M.NW
W1370.36.NW
W1370.40.NW

Lamptype	700mA
powered 700mA . (1) 3W	

Dimensions
Ø44xH38  40° reflector
Ø40  50

**build-in**  
 with encapsulated cable 1,5m - other °angle reflector on demand  
 mit gekapselter Leitung 1,5m - andere °Winkel Reflektor auf Anfrage

**W1371/.. - FELIX**

=700mA IP44



downlight for veranda profiles - with optical lens in aluminium housing - without LED driver  
 Einbaustrahler für Verandaprofilen - mit optischer Linse in einem aluminium Gehäuse - ohne Driver LED

Ref
W1371.31M.NW
W1371.36.NW
W1371.40.NW

Lamptype	700mA
powered 700mA . (1) 3W	

Dimensions
Ø44xH42  40° reflector
Ø40  56

**build-in**  
 with encapsulated cable 1,5m - other °angle reflector on demand  
 mit gekapselter Leitung 1,5m - andere °Winkel Reflektor auf Anfrage

## INDOOR | Led | FELIX

downlights for verandas and pergolas - LED colour: naturel white (NW) - other LED colours on demand

Einbaustrahler für Veranden und Pergolen - LED Farbe: naturell Weiß (NW) - andere LED Farben auf Anfrage

### W1372/.. - FELIX

=700mA



downlight for veranda profiles - with optical lens in plexi housing - without LED driver  
Einbaustrahler für Verandaprofilen - mit optischer Linse in einem plexi Gehäuse - ohne Driver LED

#### Ref

W1372.31M.NW

W1372.36.NW

W1372.40.NW

#### Lamptype

powered 700mA . (1) 3W 700mA

#### Dimensions

Ø44xH44 40° reflector

Ø40 58

#### build-in

with encapsulated cable 1,5m - other °angle reflector on demand - IP65 with closed plexi on request  
mit gekapselter Leitung 1,5m - andere °Winkel Reflektor auf Anfrage - IP65 mit geschlossenem Plexi auf Anfrage

### W1374/.. - FELIX

=700mA



downlight for veranda profiles - without LED driver  
Einbaustrahler für Verandaprofilen - ohne Driver LED

#### Ref

W1374.31M.NW

W1374.36.NW

W1374.40.NW

#### Lamptype

powered 700mA . (1) 3W 700mA

#### Dimensions

L44xB44xH38 40° reflector

Ø40 50

#### build-in

with encapsulated cable 1,5m - other °angle reflector on demand  
mit gekapselter Leitung 1,5m - andere °Winkel Reflektor auf Anfrage

### W1375/.. - FELIX

=700mA



downlight for veranda profiles - with optical lens in aluminium housing - without LED driver  
Einbaustrahler für Verandaprofilen - mit optischer Linse in einem aluminium Gehäuse - ohne Driver LED

#### Ref

W1375.31M.NW

W1375.36.NW

W1375.40.NW

#### Lamptype

powered 700mA . (1) 3W 700mA

#### Dimensions

L44xB44xH42 40° reflector

Ø40 56

#### build-in

with encapsulated cable 1,5m - other °angle reflector on demand  
mit gekapselter Leitung 1,5m - andere °Winkel Reflektor auf Anfrage

### W1376/.. - FELIX

=700mA



downlight for veranda profiles - with optical lens in plexi housing - without LED driver  
Einbaustrahler für Verandaprofilen - mit optischer Linse in einem plexi Gehäuse - ohne Driver LED

#### Ref

W1376.31M.NW

W1376.36.NW

W1376.40.NW

#### Lamptype

powered 700mA . (1) 3W 700mA

#### Dimensions

L44xB44xH44 40° reflector

Ø40 58

#### build-in

with encapsulated cable 1,5m - other °angle reflector on demand - IP65 with closed plexi on request  
mit gekapselter Leitung 1,5m - andere °Winkel Reflektor auf Anfrage - IP65 mit geschlossenem Plexi auf Anfrage

LED colours: cold white (CW) or blue (B) - other LED colours on request  
 LED Farben: kalt Weiß (CW) oder Blau (B) - andere LED Farben auf Anfrage

**3101/.. - TUCAN**

=350mA III S2 IP65 0,0800 0,5 m 05.10.02 CE



build-in wall light - without LED driver  
 Einbau Wandleuchte - ohne Driver LED

**Ref**

- 3101.14.CW
- 3101.14.B
- 3101.40.CW
- 3101.40.B

**Lamptype**

powered 350mA . (1) 1W 350mA

**Dimensions**

Ø50xD40  
 Ø36 45

**Options**

- W3109/.. - TUCAN
- W3110/.. - TUCAN
- W3111/.. - TUCAN

build-in  
 colour 14 IP20  
 Farbe 14 IP20

**3102/.. - TUCAN**

=350mA III S2 IP65 0,0900 0,5 m 05.10.02 CE



build-in wall light - without LED driver  
 Einbau Wandleuchte - ohne Driver LED

**Ref**

- 3102.14.CW
- 3102.14.B
- 3102.40.CW
- 3102.40.B

**Lamptype**

powered 350mA . (1) 1W 350mA

**Dimensions**

B50xH50xD40  
 Ø36 45

**Options**

- W3109/.. - TUCAN
- W3111/.. - TUCAN

build-in  
 colour 14 IP20  
 Farbe 14 IP20

**3103/.. - TUCAN**

=350mA III S2 IP65 0,0800 0,5 m 05.10.02 CE



build-in wall light - without LED driver  
 Einbau Wandleuchte - ohne Driver LED

**Ref**

- 3103.14.CW
- 3103.14.B
- 3103.40.CW
- 3103.40.B

**Lamptype**

powered 350mA . (1) 1W 350mA

**Dimensions**

Ø50xD40  
 Ø36 45

**Options**

- W3109/.. - TUCAN
- W3110/.. - TUCAN
- W3111/.. - TUCAN

build-in  
 colour 14 IP20  
 Farbe 14 IP20

**3104/.. - TUCAN**

=350mA III S2 IP65 0,0900 0,5 m 05.10.02 CE



build-in wall light - without LED driver  
 Einbau Wandleuchte - ohne Driver LED

**Ref**

- 3104.14.CW
- 3104.14.B
- 3104.40.CW
- 3104.40.B

**Lamptype**

powered 350mA . (1) 1W 350mA

**Dimensions**

B50xH50xD40  
 Ø36 45

**Options**

- W3109/.. - TUCAN
- W3111/.. - TUCAN

build-in  
 colour 14 IP20  
 Farbe 14 IP20

## INDOOR | Led | TUCAN

LED colours: cold white (CW) or blue (B) - other LED colours on request  
LED Farben: kalt Weiß (CW) oder Blau (B) - andere LED Farben auf Anfrage

### W3105/.. - TUCAN

=350mA III S2 IP65 0,1000 0,5 m 05.10.02 CE



build-in wall light - glass 5mm thick - without LED driver  
Einbau Wandleuchte - Glasdicke 5mm - ohne Driver LED

#### Ref

W3105.14.CW  
W3105.14.B  
W3105.40.CW  
W3105.40.B

#### Lamptype

powered 350mA . (1) 1W 350mA

#### Dimensions

Ø50xD40

Ø36 45

#### Options

W3107/.. - TUCAN  
W3109/.. - TUCAN  
W3110/.. - TUCAN  
W3111/.. - TUCAN

build-in  
colour 14 IP20  
Farbe 14 IP20

### W3107/.. - TUCAN

IP20 0,2150 CE



build-in box - for the floor  
Einbaudose - für den Boden

#### Ref

W3107

#### Dimensions

L110xB75xH40

#### Options

W3105/.. - TUCAN

### W3110/.. - TUCAN

IP20 CE



build-in tube - for the wall  
Einbaurohr - für die Wand

#### Ref

W3110

#### Dimensions

Ø52,6

#### Options

3101/.. - TUCAN  
3103/.. - TUCAN  
W3105/.. - TUCAN

### W3106/.. - TUCAN

=350mA III S2 IP65 0,1100 0,5 m 05.10.02 CE



build-in wall light - glass 5mm thick - without LED driver  
Einbau Wandleuchte - Glasdicke 5mm - ohne Driver LED

#### Ref

W3106.14.CW  
W3106.14.B  
W3106.40.CW  
W3106.40.B

#### Lamptype

powered 350mA . (1) 1W 350mA

#### Dimensions

B50xH50xD40

Ø36 45

#### Options

W3108/.. - TUCAN  
W3109/.. - TUCAN  
W3111/.. - TUCAN

build-in  
colour 14 IP20  
Farbe 14 IP20



LED colours: cold white (CW) or blue (B) - other LED colours on request  
 LED Farben: kalt Weiß (CW) oder Blau (B) - andere LED Farben auf Anfrage

**W3108/.. - TUCAN**

IP20

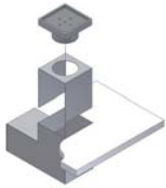

build-in box - for the floor  
 Einbaudose - für den Boden

Ref

W3108

**Dimensions**

↔ L110xB52xH75

**Options**

W3106/.. - TUCAN

**W3109/.. - TUCAN**

IP20

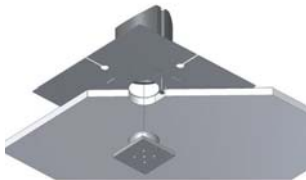

plasterkit + gyproc box  
 Einputzrahmen + Gyprocdose

Ref

W3109

🔪 Ø40

**Options**

3101/.. - TUCAN

3102/.. - TUCAN

3103/.. - TUCAN

3104/.. - TUCAN

W3105/.. - TUCAN

W3106/.. - TUCAN

**W3111/.. - TUCAN**

IP20



build-in tube - for the wall  
 Einbaurohr - für die Wand

Ref

W3111

**Dimensions**

↔ Ø41

**Options**

3101/.. - TUCAN

3102/.. - TUCAN

3103/.. - TUCAN

3104/.. - TUCAN

W3105/.. - TUCAN

W3106/.. - TUCAN

## INDOOR | Led | SCOTT

LED colours: cold white (CW) naturel white (NW) or blue (B) - other LED colours on request

LED Farben: kalt Weiß (CW) naturell Weiß (NW) oder Blau (B) - andere LED Farben auf Anfrage

### W3083.10/.. - SCOTT

=350mA



build-in wall, ceiling or floor light - stainless steel 316 - without LED driver  
Wand-, Decken- oder Bodenleuchte für Einbau - Edelstahl 316 - ohne Driver LED

#### Ref

W3083.10.5.CW

W3083.10.5.B

W3083.10.5B.CW

W3083.10.5B.B

#### Lamp type

powered 350mA . (1) 1W 350mA

#### Dimensions

Ø60xH66 10° reflector

Ø50 66

#### build-in

RGB LED + opal glass on request

RGB LED + Opalglas auf Anfrage

### W3083.25/.. - SCOTT

=350mA



build-in wall, ceiling or floor light - stainless steel 316 - without LED driver  
Wand-, Decken- oder Bodenleuchte für Einbau - Edelstahl 316 - ohne Driver LED

#### Ref

W3083.25.5.CW

W3083.25.5.B

W3083.25.5B.CW

W3083.25.5B.B

#### Lamp type

powered 350mA . (1) 1W 350mA

#### Dimensions

Ø60xH66 25° reflector

Ø50 66

#### build-in

RGB LED + opal glass on request

RGB LED + Opalglas auf Anfrage

### W3083.40/.. - SCOTT

=350mA



build-in wall, ceiling or floor light - stainless steel 316 - without LED driver  
Wand-, Decken- oder Bodenleuchte für Einbau - Edelstahl 316 - ohne Driver LED

#### Ref

W3083.40.5.CW

W3083.40.5.B

W3083.40.5B.CW

W3083.40.5B.B

#### Lamp type

powered 350mA . (1) 1W 350mA

#### Dimensions

Ø60xH66 40° reflector

Ø50 66

#### build-in

RGB LED + opal glass on request

RGB LED + Opalglas auf Anfrage

### W3083A/.. - SCOTT

=350mA



semi build-in and build-up floor or wall light - stainless steel housing + polycarbonate cover - without LED driver  
Halbeinbau und Halbaufbau Boden- oder Wandleuchte - Gehäuse in Edelstahl + Deckel in Polycarbonat - ohne Driver LED

#### Ref

W3083A.5.NW

W3083A.5.B

W3083A.5B.NW

W3083A.5B.B

#### Lamp type

powered 350mA . (1) 1W 350mA

#### Dimensions

Ø60xH77 40° reflector

Ø50 77

semi build in/up

LED colours: cold white (CW) naturel white (NW) or blue (B) - other LED colours on request  
 LED Farben: kalt Weiß (CW) naturel Weiß (NW) oder Blau (B) - andere LED Farben auf Anfrage

**W3083B/.. - SCOTT**

=350mA III S2 IP66 0.5 m 05.10.02 CE



semi build in/up

semi build-in and build-up floor or wall light - stainless steel housing + plexi with stainless steel cover plate - without LED driver  
 Halbeinbau und Halbaufbau Boden- oder Wandleuchte - Gehäuse in Edelstahl + Plexi mit Abdeckplatte in Edelstahl - ohne Driver LED

**Ref**  
 W3083B.5.NW  
 W3083B.5.B  
 W3083B.5B.NW  
 W3083B.5B.B

**Lamptype**  
 powered 350mA . (1) 1W 350mA

**Dimensions**  
 Ø60xH77 40° reflector  
 Ø50 77

**W3083C/.. - SCOTT**

=350mA III S2 IP66 0.5 m 05.10.02 CE



semi build in/up

semi build-in and build-up floor or wall light - stainless steel housing + plexi with aluminium cover - without LED driver  
 Halbeinbau und Halbaufbau Boden- oder Wandleuchte - Gehäuse in Edelstahl + Plexi mit Deckel in Aluminium - ohne Driver LED

**Ref**  
 W3083C.5.40.NW  
 W3083C.5.40.B

**Lamptype**  
 powered 350mA . (1) 1W 350mA

**Dimensions**  
 Ø60xH77 40° reflector  
 Ø50 77

**W3084.10/.. - SCOTT CARREE**

=350mA III S2 IP66 0.5 m 05.10.02 CE



build-in  
 RGB LED + opal glass on request  
 RGB LED + Opalglas auf Anfrage

build-in wall, ceiling or floor light - stainless steel 316 - without LED driver  
 Wand-, Decken- oder Bodenleuchte für Einbau - Edelstahl 316 - ohne Driver LED

**Ref**  
 W3084.10.5.CW  
 W3084.10.5.B  
 W3084.10.5B.CW  
 W3084.10.5B.B

**Lamptype**  
 powered 350mA . (1) 1W 350mA

**Dimensions**  
 L60xB60xH66 10° reflector  
 Ø50 66

**W3084.25/.. - SCOTT CARREE**

=350mA III S2 IP66 0.0688 0.5 m 05.10.02 CE



build-in  
 RGB LED + opal glass on request  
 RGB LED + Opalglas auf Anfrage

build-in wall, ceiling or floor light - stainless steel 316 - without LED driver  
 Wand-, Decken- oder Bodenleuchte für Einbau - Edelstahl 316 - ohne Driver LED

**Ref**  
 W3084.25.5.CW  
 W3084.25.5.B  
 W3084.25.5B.CW  
 W3084.25.5B.B

**Lamptype**  
 powered 350mA . (1) 1W 350mA

**Dimensions**  
 L60xB60xH66 25° reflector  
 Ø50 66

## INDOOR | Led | SCOTT CARREE

LED colours: cold white (CW) naturel white (NW) or blue (B) - other LED colours on request

LED Farben: kalt Weiß (CW) naturell Weiß (NW) oder Blau (B) - andere LED Farben auf Anfrage

### W3084.40/.. - SCOTT CARREE

≈350mA



IP66



0.0700

0.5 m

05.10.02



#### Ref

W3084.40.5.CW

W3084.40.5.B

W3084.40.5B.CW

W3084.40.5B.B

build-in wall, ceiling or floor light - stainless steel 316 - without LED driver  
Wand-, Decken- oder Bodenleuchte für Einbau - Edelstahl 316 - ohne Driver LED

#### Lamp type

powerled 350mA . (1) 1W 350mA

#### Dimensions

L60xB60xH66 40° reflector

Ø50 66



build-in  
RGB LED + opal glass on request  
RGB LED + Opalglas auf Anfrage

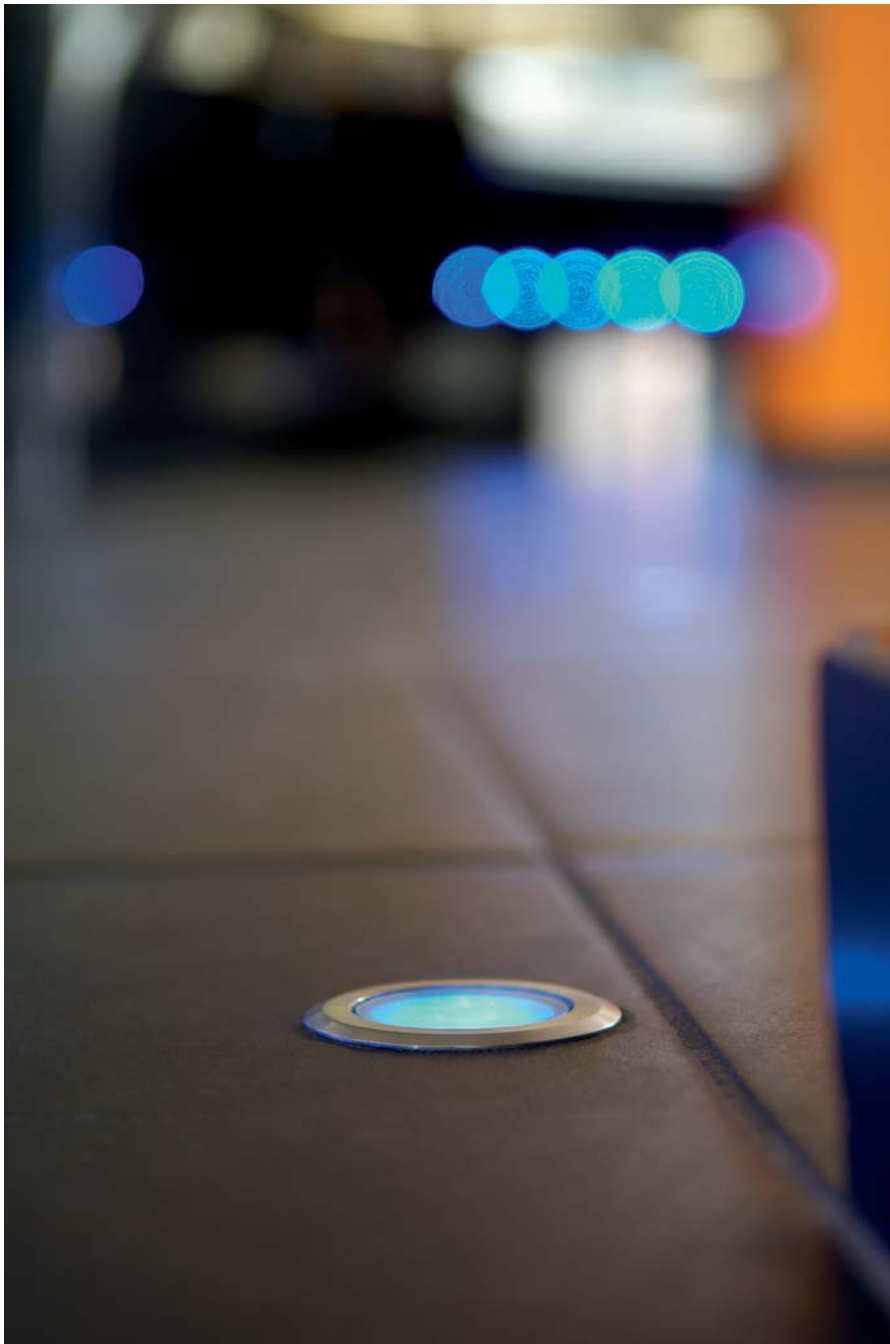

# INDOOR | Led | EXIT | TRANSFO voltage power supply

Lighting Fixture in stainless steel 316 - LED colour cold white - other LED colours on request  
 Leuchte in Edelstahl 316 - LED Farbe kalt Weiß - andere LED Farben auf Anfrage

## 3056/.. - EXIT

=14V-DC III IP44 0,1350 0,5 m 05.10.02 CE



build-in wall light - without LED driver  
 Einbau Wandleuchte - ohne Driver LED

Ref  
 3056.5

### Lamp type

led 14V-DC 40mA (1) 0,56W 14V-DC

### Dimensions

Ø70xD32

29x29 38

### Options

GEARER15PU04/.. - TRANSFO voltage power supply

*build-in  
 driver ER15PU04 to order separately  
 Driver ER15PU04 separat bestellen*

## 3057/.. - EXIT

=14V-DC III IP44 0,1500 0,5 m 05.10.02 CE



build-in wall light - without LED driver  
 Einbau Wandleuchte - ohne Driver LED

Ref  
 3057.5

### Lamp type

led 14V-DC 40mA (1) 0,56W 14V-DC

### Dimensions

B52xH52xD32

29x29 38

### Options

GEARER15PU04/.. - TRANSFO voltage power supply

*build-in  
 driver ER15PU04 to order separately  
 Driver ER15PU04 separat bestellen*

## GEARER15PU04/.. - TRANSFO voltage power supply

IP20 0,1400 CE



transformer - 14V-DC - 10W  
 Trafo

Ref  
 GEARER15PU04

### Dimensions

L100xB48xH27

ER 15PU04 driver max. 10W

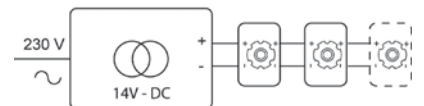

*build-in*

# INDOOR | Led | DOTS | LED PRISMA | TRANSFO voltage power supply

LED colour cold white  
LED Farbe kalt Weiß

## 3054A/.. - DOTS

=24V-DC III S2 IP20 0,0825 0,5 m 05.10.02 CE



build-in wall light - without LED driver  
Einbau Wandleuchte - ohne Driver LED

Ref

3054.11

### Lamptype

led 24V-DC 20mA (1) 0,48W 24V-DC

3054.14

### Dimensions

B80xH60xD20

70x48 20

### Options

3054A/.. - DOTS

GEARER14PU06/.. - TRANSFO voltage power supply

*build-in  
driver ER14PU06 to order separately  
Driver ER14PU06 separat bestellen*

## 3054A/.. - DOTS

IP20 0,0350 CE



build-in box  
Einbaudose

Ref

3054A

### Dimensions

B73xH50xD50

## 3055/.. - LED PRISMA

=24V-DC III S2 IP20 0,4300 0,5 m 05.10.02 CE



build-in wall light - without LED driver  
Einbau Wandleuchte - ohne Driver LED

Ref

3055.14

### Lamptype

led 24V-DC 20mA (1) 0,48W 24V-DC

### Dimensions

B80xH80xD37

76x76 37

### Options

GEARER14PU06/.. - TRANSFO voltage power supply

*build-in  
driver ER14PU06 to order separately  
Driver ER14PU06 separat bestellen*

## GEARER14PU06/.. - TRANSFO voltage power supply

IP20 0,1400 CE



transformer - 24V-DC - 10W  
Trafo

Ref

GEARER14PU06

### Dimensions

L100xB48xH27

ER 14PU06 driver max. 10W

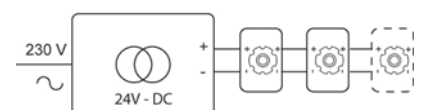

*build-in*

LED colours: cold white (CW) naturel white (NW) warm white (WW) or blue (B) - other LED colours on request  
 LED Farben: kalt Weiß (CW) naturell Weiß (NW) warm Weiß (WW) oder Blau (B) - andere LED Farben auf Anfrage



1355/./S1 - CESAR

=700mA 0,0278 0,5 m 05.10.02



build-in  
 especially for kitchen & bathroom cabinets and  
 elevators  
 für Anwendung in Badezimmer- & Küchenschranken  
 und Aufzügen

build-in ceiling and wall light - connection with terminal  
 block - without LED driver  
 Decken- und Wandleuchte für Einbau - Anschluss mit  
 Klemmenleiste - ohne Driver LED

**Lamptype**

powered 700mA . (1) 3W 700mA

**Dimensions**

Ø70xH17

Ø60 45

**Options**

S6.60/.. - PLASTERKIT

**Ref**

- 1355.1M.CW.S1
- 1355.1M.NW.S1
- 1355.1M.WW.S1
- 1355.1M.B.S1
- 1355.7.CW.S1
- 1355.7.NW.S1
- 1355.7.WW.S1
- 1355.7.B.S1
- 1355.14.CW.S1
- 1355.14.NW.S1
- 1355.14.WW.S1
- 1355.14.B.S1
- 1355.24.CW.S1
- 1355.24.NW.S1
- 1355.24.WW.S1
- 1355.24.B.S1

door

## INDOOR | Led | CESAR

LED colours: cold white (CW) naturel white (NW) warm white (WW) or blue (B) - other LED colours on request

LED Farben: kalt Weiß (CW) naturell Weiß (NW) warm Weiß (WW) oder Blau (B) - andere LED Farben auf Anfrage

### 1355/..S2 - CESAR

=700mA III WW S2 IP44 0,0375 0,5 m 05.10.02 CE



build-in  
especially for kitchen & bathroom cabinets and  
elevators  
für Anwendung in Badezimmer- & Küchenschranken  
und Aufzügen

build-in ceiling and wall light - connection with terminal  
block - without LED driver  
Decken- und Wandleuchte für Einbau - Anschluss mit  
Klemmenleiste - ohne Driver LED

#### Lamp type

powered 700mA . (1) 3W 700mA

#### Dimensions

Ø70xH17

Ø60 17,5

#### Options

S6.60/.. - PLASTERKIT

#### Ref

1355.1M.CW.S2

1355.1M.NW.S2

1355.1M.WW.S2

1355.1M.B.S2

1355.7.CW.S2

1355.7.NW.S2

1355.7.WW.S2

1355.7.B.S2

1355.14.CW.S2

1355.14.NW.S2

1355.14.WW.S2

1355.14.B.S2

1355.24.CW.S2

1355.24.NW.S2

1355.24.WW.S2

1355.24.B.S2

### 1354/..S1 - CESAR

=700mA III WW S1 IP44 0,0800 0,5 m 05.10.02 CE



build-in  
especially for kitchen & bathroom cabinets and  
elevators  
für Anwendung in Badezimmer- & Küchenschranken  
und Aufzügen

build-in ceiling and wall light - connection with terminal  
block - without LED driver  
Decken- und Wandleuchte für Einbau - Anschluss mit  
Klemmenleiste - ohne Driver LED

#### Lamp type

powered 700mA . (1) 3W 700mA

#### Dimensions

L70xB70xH17

Ø60 45

#### Options

S6.60/.. - PLASTERKIT

#### Ref

1354.1M.CW.S1

1354.1M.NW.S1

1354.1M.WW.S1

1354.1M.B.S1

1354.7.CW.S1

1354.7.NW.S1

1354.7.WW.S1

1354.7.B.S1

1354.14.CW.S1

1354.14.NW.S1

1354.14.WW.S1

1354.14.B.S1

1354.24.CW.S1

1354.24.NW.S1

1354.24.WW.S1

1354.24.B.S1



LED colours: cold white (CW) naturel white (NW) warm white (WW) or blue (B) - other LED colours on request  
 LED Farben: kalt Weiß (CW) naturell Weiß (NW) warm Weiß (WW) oder Blau (B) - andere LED Farben auf Anfrage

1354/./S2 - CESAR

=700mA III WW S2 IP44 0,0066 0,5 m 05.10.02 CE



build-in ceiling and wall light - connection with terminal block - without LED driver  
 Decken- und Wandleuchte für Einbau - Anschluss mit Klemmenleiste - ohne Driver LED

Ref

- 1354.1M.CW.S2
- 1354.1M.NW.S2
- 1354.1M.WW.S2
- 1354.1M.B.S2
- 1354.7.CW.S2
- 1354.7.NW.S2
- 1354.7.WW.S2
- 1354.7.B.S2
- 1354.14.CW.S2
- 1354.14.NW.S2
- 1354.14.WW.S2
- 1354.14.B.S2
- 1354.24.CW.S2
- 1354.24.NW.S2
- 1354.24.WW.S2
- 1354.24.B.S2

Lamp type

powered 700mA . (1) 3W 700mA

Dimensions

L70xB70xH17

Ø60 JL 17,5

Options

S6.60/.. - PLASTERKIT

build-in especially for kitchen & bathroom cabinets and elevators  
 für Anwendung in Badezimmer- & Küchenschranken und Aufzügen

1358/./S1 - CESAR

=700mA III WW S1 IP44 0,0078 0,5 m 05.10.02 CE



build-in ceiling and wall light - connection with terminal block - without LED driver  
 Decken- und Wandleuchte für Einbau - Anschluss mit Klemmenleiste - ohne Driver LED

Ref

- 1358.1M.CW.S1
- 1358.1M.NW.S1
- 1358.1M.WW.S1
- 1358.1M.B.S1
- 1358.7.CW.S1
- 1358.7.NW.S1
- 1358.7.WW.S1
- 1358.7.B.S1
- 1358.14.CW.S1
- 1358.14.NW.S1
- 1358.14.WW.S1
- 1358.14.B.S1
- 1358.24.CW.S1
- 1358.24.NW.S1
- 1358.24.WW.S1
- 1358.24.B.S1

Lamp type

powered 700mA . (1) 3W 700mA

Dimensions

L70xB70xH17

Ø60 JL 45

Options

S6.60/.. - PLASTERKIT

build-in especially for kitchen & bathroom cabinets and elevators  
 für Anwendung in Badezimmer- & Küchenschranken und Aufzügen

## INDOOR | Led | CESAR | CESAR X

LED colours: cold white (CW) naturel white (NW) warm white (WW) or blue (B) - other LED colours on request

LED Farben: kalt Weiß (CW) naturell Weiß (NW) warm Weiß (WW) oder Blau (B) - andere LED Farben auf Anfrage

### 1358/./S2 - CESAR

=700mA



build-in ceiling and wall light - connection with terminal block - without LED driver  
Decken- und Wandleuchte für Einbau - Anschluss mit Klemmenleiste - ohne Driver LED

#### Lamptype

powered 700mA . (1) 3W 700mA

#### Dimensions

L70xB70xH17

Ø60 17,5

#### Options

S6.60/.. - PLASTERKIT

#### Ref

1358.1M.CW.S2  
1358.1M.NW.S2  
1358.1M.WW.S2  
1358.1M.B.S2  
1358.7.CW.S2  
1358.7.NW.S2  
1358.7.WW.S2  
1358.7.B.S2  
1358.14.CW.S2  
1358.14.NW.S2  
1358.14.WW.S2  
1358.14.B.S2  
1358.24.CW.S2  
1358.24.NW.S2  
1358.24.WW.S2  
1358.24.B.S2

build-in  
especially for kitchen & bathroom cabinets and elevators  
für Anwendung in Badezimmer- & Küchenschranken und Aufzügen

### 1356/./S1 - CESAR X

=700mA



build-in ceiling and wall light - connection with terminal block - with optical lens in aluminium housing - without LED driver  
Decken- und Wandleuchte für Einbau - Anschluss mit Klemmenleiste - mit optischer Linse in einem aluminium Gehäuse - ohne Driver LED

#### Lamptype

powered 700mA . (1) 3W 700mA

#### Dimensions

Ø70xH17 40° reflector

Ø60 45

#### Options

S6.60/.. - PLASTERKIT

#### Ref

1356.1M.CW.S1  
1356.1M.NW.S1  
1356.1M.WW.S1  
1356.1M.B.S1  
1356.7.CW.S1  
1356.7.NW.S1  
1356.7.WW.S1  
1356.7.B.S1  
1356.14.CW.S1  
1356.14.NW.S1  
1356.14.WW.S1  
1356.14.B.S1  
1356.24.CW.S1  
1356.24.NW.S1  
1356.24.WW.S1  
1356.24.B.S1

build-in  
other °angle reflector on demand  
andere °Winkel Reflektor auf Anfrage  
especially for kitchen & bathroom cabinets and elevators  
für Anwendung in Badezimmer- & Küchenschranken und Aufzügen

LED colours: cold white (CW) naturel white (NW) warm white (WW) or blue (B) - other LED colours on request  
 LED Farben: kalt Weiß (CW) naturell Weiß (NW) warm Weiß (WW) oder Blau (B) - andere LED Farben auf Anfrage

1356/..S2 - CESAR X

=700mA III WW S2 IP20 0.5 m 05.10.02 CE



**build-in**  
 other °angle reflector on demand  
 andere °Winkel Reflektor auf Anfrage  
 especially for kitchen & bathroom cabinets and  
 elevators  
 für Anwendung in Badezimmer- & Küchenschranken  
 und Aufzügen

build-in ceiling and wall light - connection with terminal  
 block - with optical lens in aluminium housing - without LED  
 driver  
 Decken- und Wandleuchte für Einbau - Anschluss mit  
 Klemmenleiste - mit optischer Linse in einem aluminium  
 Gehäuse - ohne Driver LED

**Lamptype**

powered 700mA . (1) 3W 700mA

**Dimensions**

Ø70xH17 40° reflector

Ø60 17,5

**Options**

S6.60/.. - PLASTERKIT

**Ref**

- 1356.1M.CW.S2
- 1356.1M.NW.S2
- 1356.1M.WW.S2
- 1356.1M.B.S2
- 1356.7.CW.S2
- 1356.7.NW.S2
- 1356.7.WW.S2
- 1356.7.B.S2
- 1356.14.CW.S2
- 1356.14.NW.S2
- 1356.14.WW.S2
- 1356.14.B.S2
- 1356.24.CW.S2
- 1356.24.NW.S2
- 1356.24.WW.S2
- 1356.24.B.S2

1360/..S1 - CESAR X

=700mA III WW S1 IP20 0.5m 05.10.02 CE



**build-in**  
 other °angle reflector on demand  
 andere °Winkel Reflektor auf Anfrage  
 especially for kitchen & bathroom cabinets and  
 elevators  
 für Anwendung in Badezimmer- & Küchenschranken  
 und Aufzügen

build-in ceiling and wall light - connection with terminal  
 block - with optical lens in plexi housing - without LED driver  
 Decken- und Wandleuchte für Einbau - Anschluss mit  
 Klemmenleiste - mit optischer Linse in einem plexi Gehäuse -  
 ohne Driver LED

**Lamptype**

powered 700mA . (1) 3W 700mA

**Dimensions**

Ø70xH17 40° reflector

Ø60 45

**Options**

S6.60/.. - PLASTERKIT

**Ref**

- 1360.1M.CW.S1
- 1360.1M.NW.S1
- 1360.1M.WW.S1
- 1360.1M.B.S1
- 1360.7.CW.S1
- 1360.7.NW.S1
- 1360.7.WW.S1
- 1360.7.B.S1
- 1360.14.CW.S1
- 1360.14.NW.S1
- 1360.14.WW.S1
- 1360.14.B.S1
- 1360.24.CW.S1
- 1360.24.NW.S1
- 1360.24.WW.S1
- 1360.24.B.S1

## INDOOR | Led | CESAR X

LED colours: cold white (CW) naturel white (NW) warm white (WW) or blue (B) - other LED colours on request

LED Farben: kalt Weiß (CW) naturell Weiß (NW) warm Weiß (WW) oder Blau (B) - andere LED Farben auf Anfrage

### 1360../S2 - CESAR X

=700mA IP20



build-in ceiling and wall light - connection with terminal block - with optical lens in plexi housing - without LED driver  
Decken- und Wandleuchte für Einbau - Anschluss mit Klemmenleiste - mit optischer Linse in einem plexi Gehäuse - ohne Driver LED

#### Lamptype

powered 700mA . (1) 3W 700mA

#### Dimensions

Ø70xH17 40° reflector

Ø60 17,5

#### Options

S6.60/.. - PLASTERKIT

#### Ref

1360.1M.CW.S2  
1360.1M.NW.S2  
1360.1M.WW.S2  
1360.1M.B.S2  
1360.7.CW.S2  
1360.7.NW.S2  
1360.7.WW.S2  
1360.7.B.S2  
1360.14.CW.S2  
1360.14.NW.S2  
1360.14.WW.S2  
1360.14.B.S2  
1360.24.CW.S2  
1360.24.NW.S2  
1360.24.WW.S2  
1360.24.B.S2

#### build-in

other °angle reflector on demand  
andere °Winkel Reflektor auf Anfrage  
especially for kitchen & bathroom cabinets and elevators  
für Anwendung in Badezimmer- & Küchenschranken und Aufzügen

### 1357../S1 - CESAR X

=700mA IP20



build-in ceiling and wall light - connection with terminal block - with optical lens in aluminium housing - without LED driver  
Decken- und Wandleuchte für Einbau - Anschluss mit Klemmenleiste - mit optischer Linse in einem aluminium Gehäuse - ohne Driver LED

#### Lamptype

powered 700mA . (1) 3W 700mA

#### Dimensions

L70xB70xH17 40° reflector

Ø60 45

#### Options

S6.60/.. - PLASTERKIT

#### Ref

1357.1M.CW.S1  
1357.1M.NW.S1  
1357.1M.WW.S1  
1357.1M.B.S1  
1357.7.CW.S1  
1357.7.NW.S1  
1357.7.WW.S1  
1357.7.B.S1  
1357.14.CW.S1  
1357.14.NW.S1  
1357.14.WW.S1  
1357.14.B.S1  
1357.24.CW.S1  
1357.24.NW.S1  
1357.24.WW.S1  
1357.24.B.S1

#### build-in

other °angle reflector on demand  
andere °Winkel Reflektor auf Anfrage  
especially for kitchen & bathroom cabinets and elevators  
für Anwendung in Badezimmer- & Küchenschranken und Aufzügen

LED colours: cold white (CW) naturel white (NW) warm white (WW) or blue (B) - other LED colours on request  
 LED Farben: kalt Weiß (CW) naturell Weiß (NW) warm Weiß (WW) oder Blau (B) - andere LED Farben auf Anfrage

1357../S2 - CESAR X

=700mA III WW S2 IP20 0.5 m 05.10.02 CE



**build-in**  
 other °angle reflector on demand  
 andere °Winkel Reflektor auf Anfrage  
 especially for kitchen & bathroom cabinets and  
 elevators  
 für Anwendung in Badezimmer- & Küchenschranken  
 und Aufzügen

build-in ceiling and wall light - connection with terminal  
 block - with optical lens in aluminium housing - without LED  
 driver  
 Decken- und Wandleuchte für Einbau - Anschluss mit  
 Klemmenleiste - mit optischer Linse in einem aluminium  
 Gehäuse - ohne Driver LED

**Lamp type**

powered 700mA . (1) 3W 700mA

**Dimensions**

L70xB70xH17 40° reflector

Ø60 17,5

**Options**

S6.60/.. - PLASTERKIT

**Ref**

- 1357.1M.CW.S2
- 1357.1M.NW.S2
- 1357.1M.WW.S2
- 1357.1M.B.S2
- 1357.7.CW.S2
- 1357.7.NW.S2
- 1357.7.WW.S2
- 1357.7.B.S2
- 1357.14.CW.S2
- 1357.14.NW.S2
- 1357.14.WW.S2
- 1357.14.B.S2
- 1357.24.CW.S2
- 1357.24.NW.S2
- 1357.24.WW.S2
- 1357.24.B.S2

1359../S1 - CESAR X

=700mA III WW S1 IP20 0,0800 0,5 m 05.10.02 CE



**build-in**  
 especially for kitchen & bathroom cabinets and  
 elevators  
 für Anwendung in Badezimmer- & Küchenschranken  
 und Aufzügen

build-in ceiling and wall light - connection with terminal  
 block - with optical lens in aluminium housing - without LED  
 driver  
 Decken- und Wandleuchte für Einbau - Anschluss mit  
 Klemmenleiste - mit optischer Linse in einem aluminium  
 Gehäuse - ohne Driver LED

**Lamp type**

powered 700mA . (1) 3W 700mA

**Dimensions**

L70xB70xH17

Ø60 45

**Options**

S6.60/.. - PLASTERKIT

**Ref**

- 1359.1M.CW.S1
- 1359.1M.NW.S1
- 1359.1M.WW.S1
- 1359.1M.B.S1
- 1359.7.CW.S1
- 1359.7.NW.S1
- 1359.7.WW.S1
- 1359.7.B.S1
- 1359.14.CW.S1
- 1359.14.NW.S1
- 1359.14.WW.S1
- 1359.14.B.S1
- 1359.24.CW.S1
- 1359.24.NW.S1
- 1359.24.WW.S1
- 1359.24.B.S1

## INDOOR | Led | CESAR X

LED colours: cold white (CW) naturel white (NW) warm white (WW) or blue (B) - other LED colours on request

LED Farben: kalt Weiß (CW) naturell Weiß (NW) warm Weiß (WW) oder Blau (B) - andere LED Farben auf Anfrage

### 1359/..S2 - CESAR X

=700mA



*build-in  
especially for kitchen & bathroom cabinets and  
elevators  
für Anwendung in Badezimmer- & Küchenschranken  
und Aufzügen*

build-in ceiling and wall light - connection with terminal block - with optical lens in aluminium housing - without LED driver

Decken- und Wandleuchte für Einbau - Anschluss mit Klemmenleiste - mit optischer Linse in einem aluminium Gehäuse - ohne Driver LED

#### Lamptype

powered 700mA . (1) 3W 700mA

#### Dimensions

L70xB70xH17

Ø60 17,5

#### Options

S6.60/.. - PLASTERKIT

#### Ref

1359.1M.CW.S2

1359.1M.NW.S2

1359.1M.WW.S2

1359.1M.B.S2

1359.7.CW.S2

1359.7.NW.S2

1359.7.WW.S2

1359.7.B.S2

1359.14.CW.S2

1359.14.NW.S2

1359.14.WW.S2

1359.14.B.S2

1359.24.CW.S2

1359.24.NW.S2

1359.24.WW.S2

1359.24.B.S2

### 1361/..S1 - CESAR X

=700mA



*build-in  
other °angle reflector on demand  
andere °Winkel Reflektor auf Anfrage  
especially for kitchen & bathroom cabinets and  
elevators  
für Anwendung in Badezimmer- & Küchenschranken  
und Aufzügen*

build-in ceiling and wall light - connection with terminal block - with optical lens in plexi housing - without LED driver  
Decken- und Wandleuchte für Einbau - Anschluss mit Klemmenleiste - mit optischer Linse in einem plexi Gehäuse - ohne Driver LED

#### Lamptype

powered 700mA . (1) 3W 700mA

#### Dimensions

L70xB70xH17 40° reflector

Ø60 45

#### Options

S6.60/.. - PLASTERKIT

#### Ref

1361.1M.CW.S1

1361.1M.NW.S1

1361.1M.WW.S1

1361.1M.B.S1

1361.7.CW.S1

1361.7.NW.S1

1361.7.WW.S1

1361.7.B.S1

1361.14.CW.S1

1361.14.NW.S1

1361.14.WW.S1

1361.14.B.S1

1361.24.CW.S1

1361.24.NW.S1

1361.24.WW.S1

1361.24.B.S1

LED colours: cold white (CW) naturel white (NW) warm white (WW) or blue (B) - other LED colours on request

LED Farben: kalt Weiß (CW) naturell Weiß (NW) warm Weiß (WW) oder Blau (B) - andere LED Farben auf Anfrage

1361../S2 - CESAR X

=700mA III WW S2 IP20 0,0800 0,5 m 05.10.02 CE



**build-in**  
 other °angle reflector on demand  
 andere °Winkel Reflektor auf Anfrage  
 especially for kitchen & bathroom cabinets and  
 elevators  
 für Anwendung in Badezimmer- & Küchenschranken  
 und Aufzügen

build-in ceiling and wall light - connection with terminal  
 block - with optical lens in plexi housing - without LED driver  
 Decken- und Wandleuchte für Einbau - Anschluss mit  
 Klemmenleiste - mit optischer Linse in einem plexi Gehäuse -  
 ohne Driver LED

**Lamptype**  
 powered 700mA . (1) 3W 700mA

**Dimensions**  
 L70xB70xH17 40° reflector  
 Ø60 17,5

**Options**  
 S6.60/.. - PLASTERKIT

Ref
1361.1M.CW.S2
1361.1M.NW.S2
1361.1M.WW.S2
1361.1M.B.S2
1361.7.CW.S2
1361.7.NW.S2
1361.7.WW.S2
1361.7.B.S2
1361.14.CW.S2
1361.14.NW.S2
1361.14.WW.S2
1361.14.B.S2
1361.24.CW.S2
1361.24.NW.S2
1361.24.WW.S2
1361.24.B.S2

1362../S1 - CESAR X

=700mA III WW S1 IP20 0,0800 0,5 m 05.10.02 CE



**build-in**  
 other °angle reflector on demand  
 andere °Winkel Reflektor auf Anfrage  
 especially for kitchen & bathroom cabinets and  
 elevators  
 für Anwendung in Badezimmer- & Küchenschranken  
 und Aufzügen

build-in ceiling and wall light - connection with terminal  
 block - with optical lens in plexi housing - without LED driver  
 Decken- und Wandleuchte für Einbau - Anschluss mit  
 Klemmenleiste - mit optischer Linse in einem plexi Gehäuse -  
 ohne Driver LED

**Lamptype**  
 powered 700mA . (1) 3W 700mA

**Dimensions**  
 L70xB70xH17 40° reflector  
 Ø60 45

**Options**  
 S6.60/.. - PLASTERKIT

Ref
1362.1M.CW.S1
1362.1M.NW.S1
1362.1M.WW.S1
1362.1M.B.S1
1362.7.CW.S1
1362.7.NW.S1
1362.7.WW.S1
1362.7.B.S1
1362.14.CW.S1
1362.14.NW.S1
1362.14.WW.S1
1362.14.B.S1
1362.24.CW.S1
1362.24.NW.S1
1362.24.WW.S1
1362.24.B.S1

## INDOOR | Led | CESAR X | CESAR

LED colours: cold white (CW) naturel white (NW) warm white (WW) or blue (B) - other LED colours on request

LED Farben: kalt Weiß (CW) naturell Weiß (NW) warm Weiß (WW) oder Blau (B) - andere LED Farben auf Anfrage

### 1362../S2 - CESAR X

=700mA III WW S2 IP20 0,0800 0,5 m 05.10.02 CE



#### build-in

other °angle reflector on demand  
andere °Winkel Reflektor auf Anfrage  
especially for kitchen & bathroom cabinets and  
elevators  
für Anwendung in Badezimmer- & Küchenschranken  
und Aufzügen

build-in ceiling and wall light - connection with terminal  
block - with optical lens in plexi housing - without LED driver  
Decken- und Wandleuchte für Einbau - Anschluss mit  
Klemmenleiste - mit optischer Linse in einem plexi Gehäuse -  
ohne Driver LED

#### Lamptype

powered 700mA . (1) 3W 700mA

#### Dimensions

L70xB70xH17 40° reflector

Ø60 17,5

#### Options

S6.60/.. - PLASTERKIT

#### Ref

1362.1M.CW.S2  
1362.1M.NW.S2  
1362.1M.WW.S2  
1362.1M.B.S2  
1362.7.CW.S2  
1362.7.NW.S2  
1362.7.WW.S2  
1362.7.B.S2  
1362.14.CW.S2  
1362.14.NW.S2  
1362.14.WW.S2  
1362.14.B.S2  
1362.24.CW.S2  
1362.24.NW.S2  
1362.24.WW.S2  
1362.24.B.S2

### W1355../S1 - CESAR

=700mA III WW S1 IP54 0,0142 0,5 m 05.10.02 CE



#### build-in

especially for cooker hoods - bathrooms - showers -  
elevators  
für Anwendung in Dunstabzugshauben -  
Badezimmern - Duschen - Aufzügen

build-in ceiling and wall light - connection with 1,5m cable -  
without LED driver  
Decken- und Wandleuchte für Einbau - Anschluss mit 1,5m  
Kabel - ohne Driver LED

#### Lamptype

powered 700mA . (1) 3W 700mA

#### Dimensions

Ø70xH17

Ø60 45

#### Options

S6.60/.. - PLASTERKIT

#### Ref

W1355.7.CW.S1  
W1355.7.NW.S1  
W1355.7.WW.S1  
W1355.7.B.S1  
W1355.31.CW.S1  
W1355.31.NW.S1  
W1355.31.WW.S1  
W1355.31.B.S1  
W1355.37.CW.S1  
W1355.37.NW.S1  
W1355.37.WW.S1  
W1355.37.B.S1

### W1355../S2 - CESAR

=700mA III WW S2 IP54 0,0108 0,5 m 05.10.02 CE



#### build-in

especially for cooker hoods - bathrooms - showers -  
elevators  
für Anwendung in Dunstabzugshauben -  
Badezimmern - Duschen - Aufzügen

build-in ceiling and wall light - connection with 1,5m cable -  
without LED driver  
Decken- und Wandleuchte für Einbau - Anschluss mit 1,5m  
Kabel - ohne Driver LED

#### Lamptype

powered 700mA . (1) 3W 700mA

#### Dimensions

Ø70xH17

Ø60 17,5

#### Options

S6.60/.. - PLASTERKIT

#### Ref

W1355.7.CW.S2  
W1355.7.NW.S2  
W1355.7.WW.S2  
W1355.7.B.S2  
W1355.31.CW.S2  
W1355.31.NW.S2  
W1355.31.WW.S2  
W1355.31.B.S2  
W1355.37.CW.S2  
W1355.37.NW.S2  
W1355.37.WW.S2  
W1355.37.B.S2



LED colours: cold white (CW) naturel white (NW) warm white (WW) or blue (B) - other LED colours on request  
 LED Farben: kalt Weiß (CW) naturell Weiß (NW) warm Weiß (WW) oder Blau (B) - andere LED Farben auf Anfrage

**W1354/./S1 - CESAR**

=700mA III WW S1 IP54 0,0800 0,5 m 05.10.02 CE



build-in ceiling and wall light - connection with 1,5m cable - without LED driver  
 Decken- und Wandleuchte für Einbau - Anschluss mit 1,5m Kabel - ohne Driver LED

**Lamptype**

powered 700mA . (1) 3W 700mA

**Dimensions**

L70xB70xH17

Ø60 JL 45

**Options**

S6.60/.. - PLASTERKIT

**Ref**

- W1354.7.CW.S1
- W1354.7.NW.S1
- W1354.7.WW.S1
- W1354.7.B.S1
- W1354.31.CW.S1
- W1354.31.NW.S1
- W1354.31.WW.S1
- W1354.31.B.S1
- W1354.37.CW.S1
- W1354.37.NW.S1
- W1354.37.WW.S1
- W1354.37.B.S1

build-in especially for cooker hoods - bathrooms - showers - elevators  
 für Anwendung in Dunstabzugshauben - Badezimmern - Duschen - Aufzügen

**W1354/./S2 - CESAR**

=700mA III WW S2 IP54 0,0800 0,5 m 05.10.02 CE



build-in ceiling and wall light - connection with 1,5m cable - without LED driver  
 Decken- und Wandleuchte für Einbau - Anschluss mit 1,5m Kabel - ohne Driver LED

**Lamptype**

powered 700mA . (1) 3W 700mA

**Dimensions**

L70xB70xH17

Ø60 JL 17,5

**Options**

S6.60/.. - PLASTERKIT

**Ref**

- W1354.7.CW.S2
- W1354.7.NW.S2
- W1354.7.WW.S2
- W1354.7.B.S2
- W1354.31.CW.S2
- W1354.31.NW.S2
- W1354.31.WW.S2
- W1354.31.B.S2
- W1354.37.CW.S2
- W1354.37.NW.S2
- W1354.37.WW.S2
- W1354.37.B.S2

build-in especially for cooker hoods - bathrooms - showers - elevators  
 für Anwendung in Dunstabzugshauben - Badezimmern - Duschen - Aufzügen

**W1358/./S1 - CESAR**

=700mA III WW S1 IP54 0,0213 0,5 m 05.10.02 CE



build-in ceiling and wall light - connection with 1,5m cable - without LED driver  
 Decken- und Wandleuchte für Einbau - Anschluss mit 1,5m Kabel - ohne Driver LED

**Lamptype**

powered 700mA . (1) 3W 700mA

**Dimensions**

L70xB70xH17

Ø60 JL 45

**Options**

S6.60/.. - PLASTERKIT

**Ref**

- W1358.7.CW.S1
- W1358.7.NW.S1
- W1358.7.WW.S1
- W1358.7.B.S1
- W1358.31.CW.S1
- W1358.31.NW.S1
- W1358.31.WW.S1
- W1358.31.B.S1
- W1358.37.CW.S1
- W1358.37.NW.S1
- W1358.37.WW.S1
- W1358.37.B.S1

build-in especially for cooker hoods - bathrooms - showers - elevators  
 für Anwendung in Dunstabzugshauben - Badezimmern - Duschen - Aufzügen

**W1358/./S2 - CESAR**

=700mA III WW S2 IP54 0,0213 0,5 m 05.10.02 CE



build-in ceiling and wall light - connection with 1,5m cable - without LED driver  
 Decken- und Wandleuchte für Einbau - Anschluss mit 1,5m Kabel - ohne Driver LED

**Lamptype**

powered 700mA . (1) 3W 700mA

**Dimensions**

L70xB70xH17

Ø60 JL 17,5

**Options**

S6.60/.. - PLASTERKIT

**Ref**

- W1358.7.CW.S2
- W1358.7.NW.S2
- W1358.7.WW.S2
- W1358.7.B.S2
- W1358.31.CW.S2
- W1358.31.NW.S2
- W1358.31.WW.S2
- W1358.31.B.S2
- W1358.37.CW.S2
- W1358.37.NW.S2
- W1358.37.WW.S2
- W1358.37.B.S2

build-in especially for cooker hoods - bathrooms - showers - elevators  
 für Anwendung in Dunstabzugshauben - Badezimmern - Duschen - Aufzügen

## INDOOR | Led | CESAR X

LED colours: cold white (CW) naturel white (NW) warm white (WW) or blue (B) - other LED colours on request

LED Farben: kalt Weiß (CW) naturell Weiß (NW) warm Weiß (WW) oder Blau (B) - andere LED Farben auf Anfrage

### W1360/./S1 - CESAR X

=700mA



build-in ceiling and wall light - connection with 1,5 m cable - with optical lens in plexi housing - without LED driver  
Decken- und Wandleuchte für Einbau - Anschluss mit 1,5m Kabel - mit optischer Linse in einem plexi Gehäuse - ohne Driver LED

#### Lamptype

powered 700mA . (1) 3W 700mA

#### Dimensions

Ø70xH17

Ø60 JL 45

#### Options

S6.60/.. - PLASTERKIT

#### Ref

W1360.7.CW.S1

W1360.7.NW.S1

W1360.7.WW.S1

W1360.7.B.S1

W1360.31.CW.S1

W1360.31.NW.S1

W1360.31.WW.S1

W1360.31.B.S1

W1360.37.CW.S1

W1360.37.NW.S1

W1360.37.WW.S1

W1360.37.B.S1

build-in especially for cooker hoods - bathrooms - showers - elevators

für Anwendung in Dunstabzugshauben - Badezimmer - Duschen - Aufzügen

### W1360/./S2 - CESAR X

=700mA



build-in ceiling and wall light - connection with 1,5 m cable - with optical lens in plexi housing - without LED driver  
Decken- und Wandleuchte für Einbau - Anschluss mit 1,5m Kabel - mit optischer Linse in einem plexi Gehäuse - ohne Driver LED

#### Lamptype

powered 700mA . (1) 3W 700mA

#### Dimensions

Ø70xH17

Ø60 JL 17,5

#### Options

S6.60/.. - PLASTERKIT

#### Ref

W1360.7.CW.S2

W1360.7.NW.S2

W1360.7.WW.S2

W1360.7.B.S2

W1360.31.CW.S2

W1360.31.NW.S2

W1360.31.WW.S2

W1360.31.B.S2

W1360.37.CW.S2

W1360.37.NW.S2

W1360.37.WW.S2

W1360.37.B.S2

build-in especially for cooker hoods - bathrooms - showers - elevators

für Anwendung in Dunstabzugshauben - Badezimmer - Duschen - Aufzügen

### W1361/./S1 - CESAR X

=700mA



build-in ceiling and wall light - connection with 1,5 m cable - with optical lens in plexi housing - without LED driver  
Decken- und Wandleuchte für Einbau - Anschluss mit 1,5m Kabel - mit optischer Linse in einem plexi Gehäuse - ohne Driver LED

#### Lamptype

powered 700mA . (1) 3W 700mA

#### Dimensions

L70xB70xH17

Ø60 JL 45

#### Options

S6.60/.. - PLASTERKIT

#### Ref

W1361.7.CW.S1

W1361.7.NW.S1

W1361.7.WW.S1

W1361.7.B.S1

W1361.31.CW.S1

W1361.31.NW.S1

W1361.31.WW.S1

W1361.31.B.S1

W1361.37.CW.S1

W1361.37.NW.S1

W1361.37.WW.S1

W1361.37.B.S1

build-in especially for cooker hoods - bathrooms - showers - elevators

für Anwendung in Dunstabzugshauben - Badezimmer - Duschen - Aufzügen

### W1361/./S2 - CESAR X

=700mA



build-in ceiling and wall light - connection with 1,5 m cable - with optical lens in plexi housing - without LED driver  
Decken- und Wandleuchte für Einbau - Anschluss mit 1,5m Kabel - mit optischer Linse in einem plexi Gehäuse - ohne Driver LED

#### Lamptype

powered 700mA . (1) 3W 700mA

#### Dimensions

L70xB70xH17

Ø60 JL 17,5

#### Options

S6.60/.. - PLASTERKIT

#### Ref

W1361.7.CW.S2

W1361.7.NW.S2

W1361.7.WW.S2

W1361.7.B.S2

W1361.31.CW.S2

W1361.31.NW.S2

W1361.31.WW.S2

W1361.31.B.S2

W1361.37.CW.S2

W1361.37.NW.S2

W1361.37.WW.S2

W1361.37.B.S2

build-in especially for cooker hoods - bathrooms - showers - elevators

für Anwendung in Dunstabzugshauben - Badezimmer - Duschen - Aufzügen

LED colours: cold white (CW) naturel white (NW) warm white (WW) or blue (B) - other LED colours on request  
 LED Farben: kalt Weiß (CW) naturell Weiß (NW) warm Weiß (WW) oder Blau (B) - andere LED Farben auf Anfrage

**W1362/..S1 - CESAR X**

=700mA III WW S1 IP54 0,0800 0,5 m 05.10.02 CE



build-in ceiling and wall light - connection with 1,5 m cable - with optical lens in plexi housing - without LED driver  
 Decken- und Wandleuchte für Einbau - Anschluss mit 1,5m Kabel - mit optischer Linse in einem plexi Gehäuse - ohne Driver LED

**Ref**

W1362.7.CW.S1  
 W1362.7.NW.S1  
 W1362.7.WW.S1

**Lamptype**

powered 700mA . (1) 3W 700mA

**Dimensions**

L70xB70xH17

Ø60 45

**Options**

S6.60/.. - PLASTERKIT

W1362.7.B.S1  
 W1362.31.CW.S1  
 W1362.31.NW.S1  
 W1362.31.WW.S1  
 W1362.31.B.S1  
 W1362.37.CW.S1  
 W1362.37.NW.S1  
 W1362.37.WW.S1  
 W1362.37.B.S1

build-in especially for cooker hoods - bathrooms - showers - elevators  
 für Anwendung in Dunstabzugshauben - Badezimmer - Duschen - Aufzügen

**W1362/..S2 - CESAR X**

=700mA III WW S2 IP54 0,0800 0,5 m 05.10.02 CE



build-in ceiling and wall light - connection with 1,5 m cable - with optical lens in plexi housing - without LED driver  
 Decken- und Wandleuchte für Einbau - Anschluss mit 1,5m Kabel - mit optischer Linse in einem plexi Gehäuse - ohne Driver LED

**Ref**

W1362.7.CW.S2  
 W1362.7.NW.S2  
 W1362.7.WW.S2  
 W1362.7.B.S2  
 W1362.31.CW.S2  
 W1362.31.NW.S2  
 W1362.31.WW.S2  
 W1362.31.B.S2  
 W1362.37.CW.S2  
 W1362.37.NW.S2  
 W1362.37.WW.S2  
 W1362.37.B.S2

**Lamptype**

powered 700mA . (1) 3W 700mA

**Dimensions**

L70xB70xH17

Ø60 17,5

**Options**

S6.60/.. - PLASTERKIT

build-in especially for cooker hoods - bathrooms - showers - elevators  
 für Anwendung in Dunstabzugshauben - Badezimmer - Duschen - Aufzügen

**1365/.. - CESAR**

IP20 0,0575 CE



build-up base for downlight  
 Aufbaubase für Einbaustrahler

**Ref**

1365.1M  
 1365.7  
 1365.14  
 1365.24

**Dimensions**

Ø75xH24,5

build-up to combine with cesar recessed round zu kombinieren mit cesar Einbau rund

**1366/.. - CESAR**

IP20 0,0575 CE



build-up base for downlight  
 Aufbaubase für Einbaustrahler

**Ref**

1366.1M  
 1366.7  
 1366.14  
 1366.24

**Dimensions**

L75xB75xH24,5

build-up to combine with cesar recessed square zu kombinieren mit cesar Einbau quadratisch

## INDOOR | Led | CESAR

LED colours: cold white (CW) naturel white (NW) warm white (WW) or blue (B) - other LED colours on request  
LED Farben: kalt Weiß (CW) naturell Weiß (NW) warm Weiß (WW) oder Blau (B) - andere LED Farben auf Anfrage

### 1367/.. - CESAR

IP20   



build-up base for downlight  
Aufbaubase für Einbaustrahler

#### Dimensions

↔ L75xB75xH24,5

#### Ref

1367.1M

1367.7

1367.11M

1367.14

1367.24

**build-up**  
to combine with cesar recessed square  
zu kombinieren mit cesar Einbau quadratisch

### W1365/.. - CESAR

IP20   



build-up base for downlight  
Aufbaubase für Einbaustrahler

#### Dimensions

↔ Ø75xH24,5

#### Ref

W1365.7

W1365.31

W1365.37

**build-up**  
to combine with cesar recessed round  
zu kombinieren mit cesar Einbau rund

### W1366/.. - CESAR

IP20    



build-up base for downlight  
Aufbaubase für Einbaustrahler

#### Dimensions

↔ L75xB75xH24,5

#### Ref

W1366.7

W1366.31

W1366.37

**build-up**  
to combine with cesar recessed square  
zu kombinieren mit cesar Einbau quadratisch

### W1367/.. - CESAR

IP20   



build-up base for downlight  
Aufbaubase für Einbaustrahler

#### Dimensions

↔ L75xB75xH24,5

#### Ref

W1367.7

W1367.31

W1367.37

**build-up**  
to combine with cesar recessed square  
zu kombinieren mit cesar Einbau quadratisch

other LED colours on request  
andere LED Farben auf Anfrage

1344/..S1 - OSCAR

=350mA III S1 IP20 0,4100 0,5m 05.10.02



build-in wall light - with glass - without LED driver  
Einbau Wandleuchte - mit Glas - ohne Driver LED

Ref  
1344.1M.CW.B.S1  
1344.5.CW.B.S1

**Lamp type**  
powered 350mA . (2) 1W 350mA

**Dimensions**  
L85xB85xH65  
74x74 65

**Options**  
1347/..A - OSCAR

build-in  
standard inside cold white LED - outside blue LED  
standard LED Farbe innen kalt Weiß - außen Blau

1344/..S2 - OSCAR

=350mA III S2 IP20 0,4100 0,5m 05.10.02



build-in wall light - with glass - without LED driver  
Einbau Wandleuchte - mit Glas - ohne Driver LED

Ref  
1344.1M.CW.B.S2  
1344.5.CW.B.S2

**Lamp type**  
powered 350mA . (2) 1W 350mA

**Dimensions**  
L85xB85xH65  
74x74 65

**Options**  
1347/..A - OSCAR  
1347/..B - OSCAR  
1347/..C - OSCAR

build-in  
standard inside cold white LED - outside blue LED  
standard LED Farbe innen kalt Weiß - außen Blau

1347/..A - OSCAR

IP20 0,0650

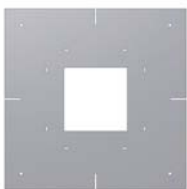

plasterkit  
Einputzrahmen

Ref  
1347.A

**Dimensions**  
L225xB225

build-in

1347/..B - OSCAR

IP20 0,0650



build-in box - for flat springs S2  
Einbaudose - für Blattfedern S2

Ref  
1347.B

**Dimensions**  
B75xH75xD67

build-in

## INDOOR | Led | OSCAR

other LED colours on request  
andere LED Farben auf Anfrage

### 1347/./C - OSCAR



build-in box - with room for driver - for S2 springs  
Einbaudose - mit Platz für Driver - für Blattfedern S2

Ref

1347.C

#### Dimensions

↔ B75xH125xD67

build-in

### 1346/./S1 - OSCAR



build-in wall light - with glass - without LED driver  
Einbau Wandleuchte - mit Glas - ohne Driver LED

Ref

1346.1M.CW.B.S1

1346.5.CW.B.S1

#### Lamp type

⚙️ powered 350mA . (2) 1W 350mA

#### Dimensions

↔ Ø85xH65

📏 Ø74 ↙ 65

#### Options

S6.75/.. - PLASTERKIT

build-in

standard inside cold white LED - outside blue LED  
standard LED Farbe innen kalt Weiß - außen Blau

### 1346/./S2 - OSCAR



build-in wall light - with glass - without LED driver  
Einbau Wandleuchte - mit Glas - ohne Driver LED

Ref

1346.1M.CW.B.S2

1346.5.CW.B.S2

#### Lamp type

⚙️ powered 350mA . (2) 1W 350mA

#### Dimensions

↔ Ø85xH65

📏 Ø74 ↙ 65

#### Options

1348/./B - OSCAR

1348/./C - OSCAR

S6.75/.. - PLASTERKIT

build-in

standard inside cold white LED - outside blue LED  
standard LED Farbe innen kalt Weiß - außen Blau

### 1348/./B - OSCAR



build-in box - for flat springs S2  
Einbaudose - für Blattfedern S2

Ref

1348.B

#### Dimensions

↔ B75xH75xD67

build-in

other LED colours on request  
andere LED Farben auf Anfrage

1348/./C - OSCAR



build-in box - with room for driver - for S2 springs  
Einbaudose - mit Platz für Driver - für Blattfedern S2

Ref

1348.C

Dimensions

↔ B74xH125xD67

build-in

1345/./S1 - OSCAR X



build-in wall light - with stainless steel centre plate - without LED driver  
Einbau Wandleuchte - mit Mittelplatte in Edelstahl - ohne Driver LED

Ref

1345.1M.CW.S1

1345.1M.B.S1

Lamptype

1345.5.CW.S1

1345.5.B.S1

⚙️ powered 350mA . (1) 1W

350mA

Dimensions

↔ Ø85xH45

📏 Ø74 ↙ ↘ 48

Options

S6.75/.. - PLASTERKIT

build-in  
LED blue or cold white  
LED Blau oder kalt Weiß

1345/./S2 - OSCAR X



build-in wall light - with stainless steel centre plate - without LED driver  
Einbau Wandleuchte - mit Mittelplatte in Edelstahl - ohne Driver LED

Ref

1345.1M.CW.S2

1345.1M.B.S2

Lamptype

1345.5.CW.S2

1345.5.B.S2

⚙️ powered 350mA . (1) 1W

350mA

Dimensions

↔ Ø85xH45

📏 Ø74 ↙ ↘ 48

Options

1348/./B - OSCAR

1348/./C - OSCAR

S6.75/.. - PLASTERKIT

build-in  
LED blue or cold white  
LED Blau oder kalt Weiß

1351/./S1 - OSCAR X



build-in wall light - with stainless steel centre plate - without LED driver  
Einbau Wandleuchte - mit Mittelplatte in Edelstahl - ohne Driver LED

Ref

1351.1M.CW.S1

1351.1M.B.S1

Lamptype

1351.5.CW.S1

1351.5.B.S1

⚙️ powered 350mA . (1) 1W

350mA

Dimensions

↔ L85xB85xH45

📏 74x74 ↙ ↘ 48

Options

1347/./A - OSCAR

build-in  
LED blue or cold white  
LED Blau oder kalt Weiß

# INDOOR | Led | OSCAR X

other LED colours on request  
andere LED Farben auf Anfrage

## 1351../S2 - OSCAR X

=350mA III S2 IP20 0,1737 0,5 m 05.10.02



**build-in**  
LED blue or cold white  
LED Blau oder kalt Weiß

build-in wall light - with stainless steel centre plate - without LED driver  
Einbau Wandleuchte - mit Mittelplatte in Edelstahl - ohne Driver LED

**Ref**  
1351.1M.CW.S2  
1351.1M.B.S2  
1351.5.CW.S2  
1351.5.B.S2

### Lamptype

powered 350mA . (1) 1W 350mA

### Dimensions

L85xB85xH45

74x74 48

### Options

1347../A - OSCAR  
1347../B - OSCAR  
1347../C - OSCAR

## 1352../S1 - OSCAR X

=350mA III S1 IP20 0,0800 0,5 m 05.10.02



**build-in**  
LED blue or cold white  
LED Blau oder kalt Weiß

build-in wall light - with stainless steel centre plate - without LED driver  
Einbau Wandleuchte - mit Mittelplatte in Edelstahl - ohne Driver LED

**Ref**  
1352.1M.CW.S1  
1352.1M.B.S1  
1352.5.CW.S1  
1352.5.B.S1

### Lamptype

powered 350mA . (1) 1W 350mA

### Dimensions

L85xB85xH45

74x74 48

### Options

1347../A - OSCAR

## 1352../S2 - OSCAR X

=350mA III S2 IP20 0,0800 0,5 m 05.10.02



**build-in**  
LED blue or cold white  
LED Blau oder kalt Weiß

build-in wall light - with stainless steel centre plate - without LED driver  
Einbau Wandleuchte - mit Mittelplatte in Edelstahl - ohne Driver LED

**Ref**  
1352.1M.CW.S2  
1352.1M.B.S2  
1352.5.CW.S2  
1352.5.B.S2

### Lamptype

powered 350mA . (1) 1W 350mA

### Dimensions

L85xB85xH45

74x74 48

### Options

1347../A - OSCAR  
1347../B - OSCAR  
1347../C - OSCAR

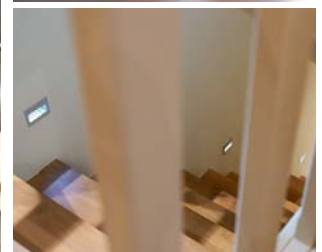



# INDOOR | Led | SINGLE MOON | SINGLE MOON + GLASS

LED colours: cold white (CW) warm white (WW) or blue (B) - other LED colours on request

LED Farben: kalt Weiß (CW) warm Weiß (WW) oder Blau (B) - andere LED Farben auf Anfrage

## 1244.LED/.. - SINGLE MOON

=350mA IP20 0,3600 0,5 m 05.10.02



build-in wall light - without LED driver  
Einbau Wandleuchte - ohne Driver LED

### Lamp type

powered 350mA . (1) 1W 350mA

### Dimensions

B100xH90xD55

85x80 55

### Options

1245A/.. - SINGLE MOON box ZT

1245B/.. - SINGLE MOON box VT

### Ref

1244.LED.5.CW

1244.LED.5.WW

1244.LED.5.B

1244.LED.13.CW

1244.LED.13.WW

1244.LED.13.B

1244.LED.16.CW

1244.LED.16.WW

1244.LED.16.B

build-in

## 1244.LED/.. /GL - SINGLE MOON + GLASS

=350mA IP20 0,3333 0,5 m 05.10.02



build-in wall light - without LED driver  
Einbau Wandleuchte - ohne Driver LED

### Lamp type

powered 350mA . (1) 1W 350mA

### Dimensions

B100xH90xD55

85x80 55

### Options

1245A/.. - SINGLE MOON box ZT

1245B/.. - SINGLE MOON box VT

### Ref

1244.LED.5.CW.GL

1244.LED.5.WW.GL

1244.LED.5.B.GL

1244.LED.13.CW.GL

1244.LED.13.WW.GL

1244.LED.13.B.GL

1244.LED.16.CW.GL

1244.LED.16.WW.GL

1244.LED.16.B.GL

build-in

## 1245A/.. - SINGLE MOON box ZT

IP20 0,0650



build-in box - no room for transformer  
Einbaudose - kein Platz für Trafo

### Dimensions

B85xH80xD60

### Ref

1245A

build-in

## 1245B/.. - SINGLE MOON box VT

~230V IP20 0,1500



build-in box - with room for transformer  
Einbaudose - mit Platz für Trafo

### Dimensions

B85xH205xD55

### Ref

1245B

build-in

## INDOOR | Led | TRIPLE MOON | TRIPLE MOON + GLASS

LED colours: cold white (CW) warm white (WW) or blue (B) - other LED colours on request  
 LED Farben: kalt Weiß (CW) warm Weiß (WW) oder Blau (B) - andere LED Farben auf Anfrage

### 1246.LED/.. - TRIPLE MOON

=350mA IP20 0,6400 0,5 m 05.10.02



build-in wall light - without LED driver  
 Einbau Wandleuchte - ohne Driver LED

#### Lamp type

powered 350mA . (1) 3x1W 350mA

#### Dimensions

B180xH90xD55

165x76 55

#### Options

1247A/.. - TRIPLE MOON box ZT

1247B/.. - TRIPLE MOON box VT

#### Ref

1246.LED.5.CW

1246.LED.5.WW

1246.LED.5.B

1246.LED.13.CW

1246.LED.13.WW

1246.LED.13.B

1246.LED.16.CW

1246.LED.16.WW

1246.LED.16.B

build-in

### 1246.LED/.. /GL - TRIPLE MOON + GLASS

=350mA IP20 0,6400 0,5 m 05.10.02



build-in wall light - without LED driver  
 Einbau Wandleuchte - ohne Driver LED

#### Lamp type

powered 350mA . (1) 3x1W 350mA

#### Dimensions

B180xH90xD55

165x76 55

#### Options

1247A/.. - TRIPLE MOON box ZT

1247B/.. - TRIPLE MOON box VT

#### Ref

1246.LED.5.CW.GL

1246.LED.5.WW.GL

1246.LED.5.B.GL

1246.LED.13.CW.GL

1246.LED.13.WW.GL

1246.LED.13.B.GL

1246.LED.16.CW.GL

1246.LED.16.WW.GL

1246.LED.16.B.GL

build-in

### 1247A/.. - TRIPLE MOON box ZT

IP20 0,1000



build-in box - no room for transformer  
 Einbaudose - kein Platz für Trafo

#### Dimensions

B165xH80xD60

#### Ref

1247A

build-in

### 1247B/.. - TRIPLE MOON box VT

~230V IP20 0,2000



build-in box - with room for transformer  
 Einbaudose - mit Platz für Trafo

#### Dimensions

B165xH150xD65

#### Ref

1247B

build-in

LED colours: cold white (CW) warm white (WW) or blue (B) - other LED colours on request  
 LED Farben: kalt Weiß (CW) warm Weiß (WW) oder Blau (B) - andere LED Farben auf Anfrage

1248.LED/.. - MOON

=350mA III S2 IP20 1,4000 0,5 m 05.10.02



build-in wall light - without LED driver  
 Einbau Wandleuchte - ohne Driver LED

Ref

- 1248.LED.5.CW
- 1248.LED.5.WW
- 1248.LED.5.B
- 1248.LED.13.CW
- 1248.LED.13.WW
- 1248.LED.13.B
- 1248.LED.16.CW
- 1248.LED.16.WW
- 1248.LED.16.B

Lamp type

powered 350mA . (1) 3x1W 350mA

Dimensions

B180xH180xD65  
 166x166 65

Options

- 1249A/.. - MOON box ZT
- 1249B/.. - MOON box VT

build-in

1248.LED/.. /GL - MOON + GLASS

=350mA III S2 IP20 1,4000 0,5 m 05.10.02



build-in wall light - without LED driver  
 Einbau Wandleuchte - ohne Driver LED

Ref

- 1248.LED.5.CW.GL
- 1248.LED.5.WW.GL
- 1248.LED.5.B.GL
- 1248.LED.13.CW.GL
- 1248.LED.13.WW.GL
- 1248.LED.13.B.GL
- 1248.LED.16.CW.GL
- 1248.LED.16.WW.GL
- 1248.LED.16.B.GL

Lamp type

powered 350mA . (1) 3x1W 350mA

Dimensions

B180xH180xD65  
 166x166 65

Options

- 1249A/.. - MOON box ZT
- 1249B/.. - MOON box VT

build-in

1249A/.. - MOON box ZT

IP20 0,1900



build-in box - no room for transformer  
 Einbaudose - kein Platz für Trafo

Ref

- 1249A

Dimensions

B168xH165xD72

build-in

1249B/.. - MOON box VT

~230V IP20 0,3000



build-in box - with room for transformer  
 Einbaudose - mit Platz für Trafo

Ref

- 1249B

Dimensions

B165xH240xD72

build-in

# INDOOR | Led | SUN | SUN + Glass | SUN

LED colours: cold white (CW) or warm white (WW) - other LED colours on request  
 LED Farben: kalt Weiß (CW) oder warm Weiß (WW) - andere LED Farben auf Anfrage

## 1240.LED/.. - SUN

=350mA



build-in



build-in wall light - without LED driver  
 Einbau Wandleuchte - ohne Driver LED

### Lamp type

powered 350mA . (1) 1W 350mA

### Dimensions

Ø92xH55

Ø80 55

### Options

1241A/.. - SUN

1241B/.. - SUN

### Ref

1240.LED.1.CW

1240.LED.1.WW

1240.LED.7.CW

1240.LED.7.WW

1240.LED.11.CW

1240.LED.11.WW

1240.LED.13.CW

1240.LED.13.WW

1240.LED.14.CW

1240.LED.14.WW

1240.LED.16.CW

1240.LED.16.WW

## 1240.LED/.. /GL - SUN + Glass

=350mA



build-in



build-in wall light - without LED driver  
 Einbau Wandleuchte - ohne Driver LED

### Lamp type

powered 350mA . (1) 1W 350mA

### Dimensions

Ø92xH55

Ø80 55

### Options

1241A/.. - SUN

1241B/.. - SUN

### Ref

1240.LED.14.CW.GL

1240.LED.14.WW.GL

1240.LED.16.CW.GL

1240.LED.16.WW.GL

## 1241A/.. - SUN

IP20



build-in



build-in box - no room for transformer  
 Einbaudose - kein Platz für Trafo

### Dimensions

Ø80xH67

### Ref

1241A

## 1241B/.. - SUN

~230V IP20

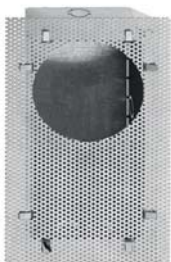

build-in



build-in box - with room for transformer  
 Einbaudose - mit Platz für Trafo

### Dimensions

B85xH170xD65

### Ref

1241B

1230.LED.GYP/.. - MIRO

~230V



build-in wall light  
Einbau Wandleuchte

Ref

1230.LED.GYP.40.CW  
1230.LED.GYP.40.B

Lamptype

led 230V . (1) 1W 230V

Dimensions

B90xH90xD60

Ø68 60

Options

1231/.. - MIRO plasterkit

build-in

1230.LED/.. - MIRO

~230V



build-in wall light  
Einbau Wandleuchte

Ref

1230.LED.40.CW  
1230.LED.40.B

Lamptype

led 230V . (1) 1W 230V

Dimensions

B90xH90xD60

79x68 61

Options

1231/.. - MIRO plasterkit

build-in

1231/.. - MIRO plasterkit

IP20

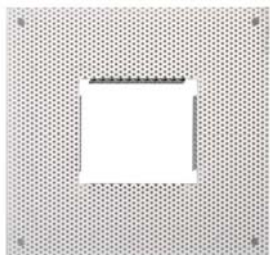
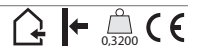

plasterkit  
Einputzrahmen

Ref

1231

Dimensions

L180xB170

79x68

3058/.. - PRADO

~230V



build-in wall light - polycarbonate  
Einbau Wandleuchte - Polykarbonat

Ref

3058.5

Lamptype

3 led 230V . (1) 4,8VA 230V

Dimensions

B80xH80xD57

51x49 57

Options

3058B/.. - PRADO box

build-in

3058B/.. - PRADO box

IP20    0,0400 



build-in box - Helia nr 96  
Einbaudose - Helia Nr 96

Ref

3058B

Dimensions

 L68xB68xH68

3059/.. - PRADO X

~230V  S2 IP20    0,2820  0,5 m  05.10.02 



build-in wall light - polycarbonate  
Einbau Wandleuchte - Polykarbonat

Ref

3059.5

Lamp type

 3 led 230V . (2) 4,8VA 230V

Dimensions

 B120xH80xD57

 96x49  57

Options

3059B/.. - PRADO X box

build-in

3059B/.. - PRADO X box

 IP20    0,0710 



build-in box  
Einbaudose

Ref

3059B

Dimensions

 B105xH70xD68



12V / 24V ~AC or 12V / 24V =DC on request - LED colour cold white 6500K (CW) - natural white 4000K (NW) - warm white 2800K (WW) - (for 1,4W version only colour NW) blue (B) or green (GR) on request - 12V / 24V ~AC oder 12V / 24V =DC auf Anfrage - LED Farbe kalt Weiß 6500K (CW) - naturell Weiß 4000K (NW) - warm Weiß 2800K (WW) (für Version 1,4W nur Farbe NW) - Blau (B) oder Grün (GR) auf Anfrage



1630B/.. - MIA

~230V IP20 0,0207 05.10.02



build-in wall light - complete with cover plate  
Einbau Wandleuchte - komplett mit Abdeckplatte

**Lamptype**

led 230V . (1) 1,4W 230V

**Dimensions**

L85xB85

50

**Ref**

- 1630B.1M.NW
- 1630B.10.NW
- 1630B.13.NW
- 1630B.14.NW
- 1630B.23.NW
- 1630B.40.NW
- 1630B.RAL 9001.NW

**build-in**  
for Helia box nr 275-276 (not included)  
für Helia Dose nr 275-276 (nicht einbegriffen)  
for bedrooms - less brightness  
für Schlafzimmer - weniger Lichtstärke

door

## INDOOR | Led | MIA

12V / 24V ~AC or 12V / 24V =DC on request - LED colour cold white 6500K (CW) - natural white 4000K (NW) - warm white 2800K (WW) - (for 1,4W version only colour NW) blue (B) or green (GR) on request - 12V / 24V ~AC oder 12V / 24V =DC auf Anfrage - LED Farbe kalt Weiß 6500K (CW) - naturell Weiß 4000K (NW) - warm Weiß 2800K (WW) (für Version 1,4W nur Farbe NW) - Blau (B) oder Grün (GR) auf Anfrage

### 1630/.. - MIA

~230V  IP20    0.0212  05.10.02 



build-in wall light - complete with cover plate  
Einbau Wandleuchte - komplett mit Abdeckplatte

#### Lamptype

 led 230V . (1) 3W 230V

#### Dimensions

 L85xB85

 50

#### Ref

1630.1M.CW  
1630.1M.NW  
1630.1M.WW  
1630.10.CW  
1630.10.NW  
1630.10.WW  
1630.13.CW  
1630.13.NW  
1630.13.WW  
1630.14.CW  
1630.14.NW  
1630.14.WW  
1630.23.CW  
1630.23.NW  
1630.23.WW  
1630.40.CW  
1630.40.NW  
1630.40.WW  
1630.RAL 9001.CW  
1630.RAL 9001.NW  
1630.RAL 9001.WW

**build-in**  
for Helia box nr 275-276 (not included)  
für Helia Dose nr 275-276 (nicht einbegriffen)

### 1631B/.. - MIA

~230V  IP20    05.10.02 



build-in wall light - complete with cover plate  
Einbau Wandleuchte - komplett mit Abdeckplatte

#### Lamptype

 led 230V . (1) 1,4W 230V

#### Dimensions

 L115xB80

 50

#### Ref

1631B.1M.NW  
1631B.10.NW  
1631B.13.NW  
1631B.14.NW  
1631B.23.NW  
1631B.40.NW  
1631B.RAL 9001.NW

**build-in**  
for Bticino box nr 503 (not included)  
für Bticino Dose nr 503 (nicht einbegriffen)  
for bedrooms - less brightness  
für Schlafzimmer - weniger Lichtstärke



12V / 24V ~AC or 12V / 24V =DC on request - LED colour cold white 6500K (CW) - natural white 4000K (NW) - warm white 2800K (WW) - (for 1,4W version only colour NW) blue (B) or green (GR) on request - 12V / 24V ~AC oder 12V / 24V =DC auf Anfrage - LED Farbe kalt Weiß 6500K (CW) - naturell Weiß 4000K (NW) - warm Weiß 2800K (WW) (für Version 1,4W nur Farbe NW) - Blau (B) oder Grün (GR) auf Anfrage

1631../. - MIA

~230V  IP20    05.10.02 

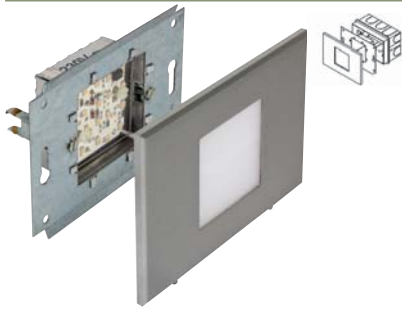

build-in wall light - complete with cover plate  
Einbau Wandleuchte - komplett mit Abdeckplatte

Lamptype

 led 230V .(1) 3W 230V

Dimensions

 L115x80

 50

Ref

- 1631.1M.CW
- 1631.1M.NW
- 1631.1M.WW
- 1631.10.CW
- 1631.10.NW
- 1631.10.WW
- 1631.13.CW
- 1631.13.NW
- 1631.13.WW
- 1631.14.CW
- 1631.14.NW
- 1631.14.WW
- 1631.23.CW
- 1631.23.NW
- 1631.23.WW
- 1631.40.CW
- 1631.40.NW
- 1631.40.WW
- 1631.RAL 9001.CW
- 1631.RAL 9001.NW
- 1631.RAL 9001.WW

build-in  
for Bticino box nr 503 (not included)  
für Bticino Dose nr 503 (nicht einbegriffen)

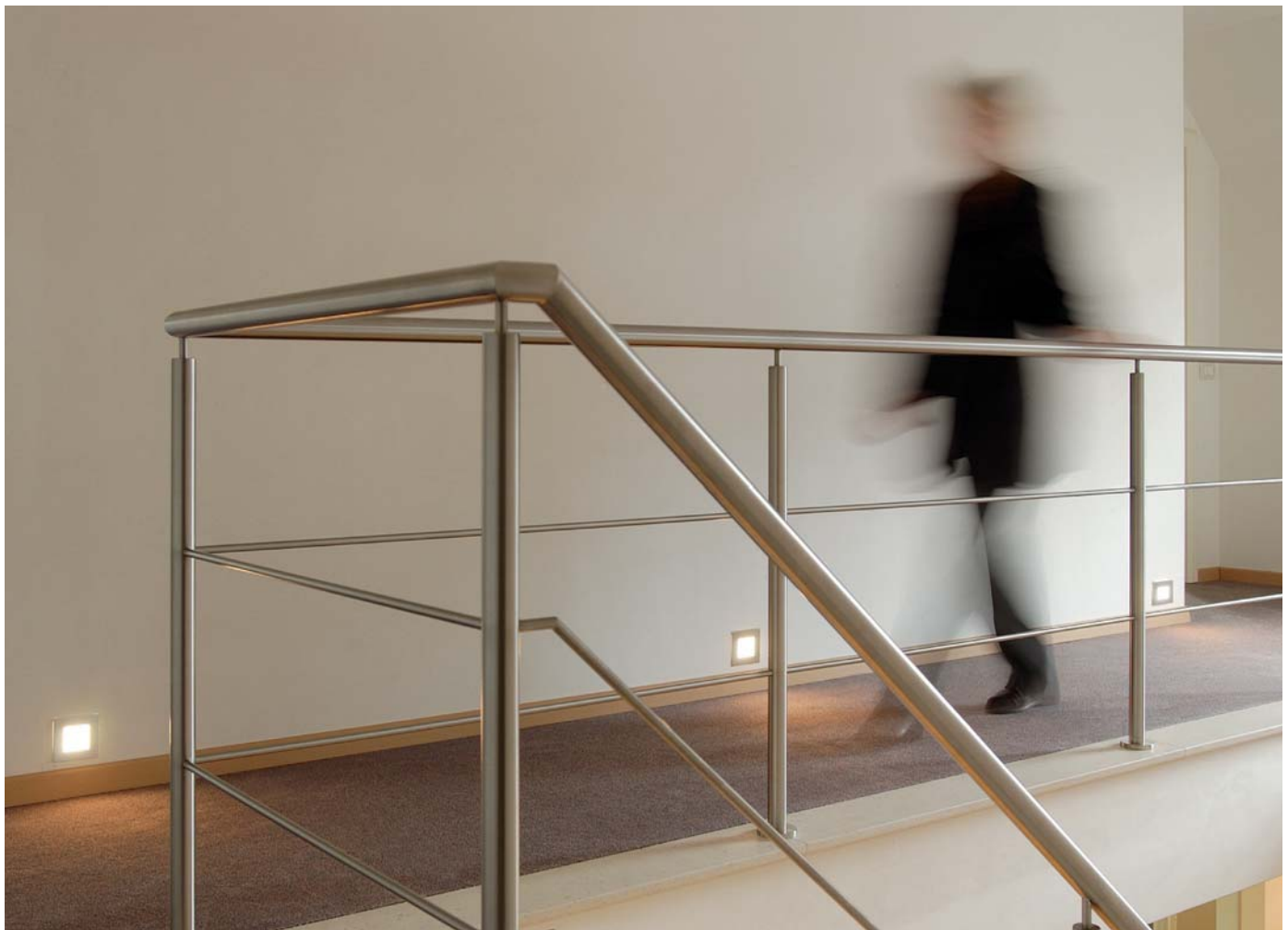

LED indoor

## INDOOR | Led | MIA X - voor niko afdekkader

only frame + led - for NIKO cover plate (not included) - LED colour cold white 6500K (CW) - natural white 4000K (NW) - warm white 2800K (WW) - blue (B) or green (GR) - for Helia box 275-276 or gyproc box (not included) - nur frame + led - für NIKO Abdeckplatte (nicht einbegriffen) - LED Farbe kalt Weiß 6500K (CW) - naturell Weiß 4000K (NW) - warm Weiß 2800K (WW) - Blau (B) oder Grün (GR) - für Helia Dose 275-276 oder gyproc Dose (nicht einbegriffen)

### 1634B.230V/.. - MIA X - voor niko afdekkader

~230V  IP20    0.1100  05.10.02 

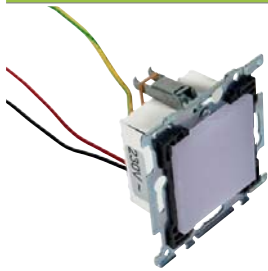

**niko**

build-in wall light  
Einbau Wandleuchte

#### Lamptype

 led 230V . (1) 1,4W 230V

#### Ref

1634B.230V.NW

*build-in  
for bedrooms - less brightness  
für Schlafzimmer - weniger Lichtstärke*

### 1634.230V/.. - MIA X - voor niko afdekkader

~230V  IP20    0.0840  05.10.02 

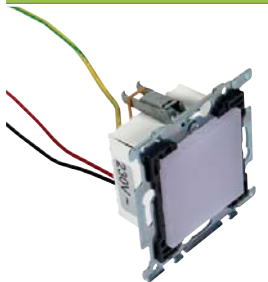

**niko**

build-in wall light  
Einbau Wandleuchte

#### Lamptype

 led 230V . (1) 3W 230V

#### Ref

1634.230V.CW  
1634.230V.NW  
1634.230V.WW  
1634.230V.B  
1634.230V.GR

*build-in*

### 1634.12V-AC/.. - MIA X - voor niko afdekkader

~12V-AC   IP20    0.0210  05.10.02 

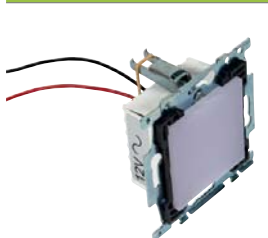

**niko**

build-in wall light - alternating current - without transformer  
Einbau Wandleuchte - Wechselstrom - ohne Trafo

#### Lamptype

 led 12V-AC . (1) 3W 12V-AC

#### Ref

1634.12V-AC.CW  
1634.12V-AC.NW  
1634.12V-AC.WW  
1634.12V-AC.B  
1634.12V-AC.GR

*build-in*

### 1634.12V-DC/.. - MIA X - voor niko afdekkader

=12V-DC   IP20    05.10.02 

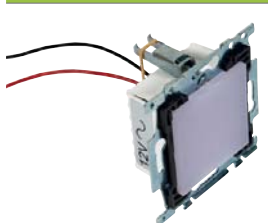

**niko**

build-in wall light - direct current - without transformer  
Einbau Wandleuchte - Gleichstrom - ohne Trafo

#### Lamptype

 led 12V-DC . (1) 3W 12V-DC

#### Ref

1634.12V-DC.CW  
1634.12V-DC.NW  
1634.12V-DC.WW  
1634.12V-DC.B  
1634.12V-DC.GR

*build-in*

## INDOOR | Led | MIA X - voor niko afdekkader

only frame + led - for NIKO cover plate (not included) - LED colour cold white 6500K (CW) - natural white 4000K (NW) - warm white 2800K (WW) - blue (B) or green (GR) - for Helia box 275-276 or gyproc box (not included) - nur frame + led - für NIKO Abdeckplatte (nicht einbegriffen) - LED Farbe kalt Weiß 6500K (CW) - naturell Weiß 4000K (NW) warm Weiß 2800K (WW) - Blau (B) oder Grün (GR) - für Helia Dose 275-276 oder gyproc Dose (nicht einbegriffen)

### 1634.24V-AC/.. - MIA X - voor niko afdekkader

~24V-AC IP20

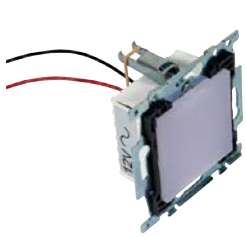

build-in wall light - alternating current - without transformer  
Einbau Wandleuchte - Wechselstrom - ohne Trafo

#### Lamptype

led 24V-AC . (1) 3W 24V-AC

#### Ref

1634.24V-AC.CW  
1634.24V-AC.NW  
1634.24V-AC.WW  
1634.24V-AC.B  
1634.24V-AC.GR

build-in

### 1634.24V-DC/.. - MIA X - voor niko afdekkader

=24V-DC IP20

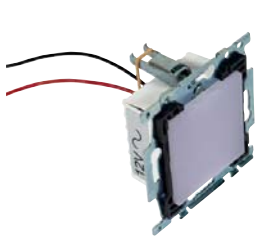

build-in wall light - direct current - without transformer  
Einbau Wandleuchte - Gleichstrom - ohne Trafo

#### Lamptype

led 24V-DC . (1) 3W 24V-DC

#### Ref

1634.24V-DC.CW  
1634.24V-DC.NW  
1634.24V-DC.WW  
1634.24V-DC.B  
1634.24V-DC.GR

build-in

LED indoor

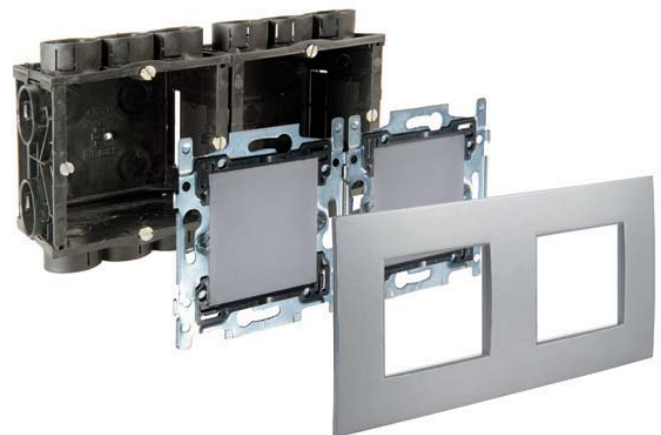
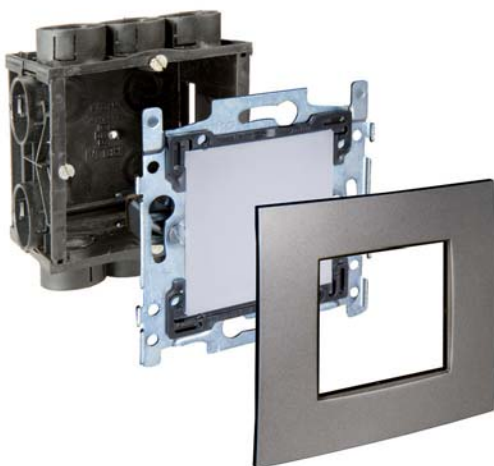

## INDOOR | Led | BRUNA voor frame bticino

only convertible LED cassette for several applications (to build in and build up) - e.g. for all frames BTICINO (2 modules) - without build-in box - LED colour cold white 6500K (CW) - natural white 4000K (NW) - warm white 2800K (WW) - blue (B) or green (GR) - nur austauschbare LED Kassette für verschiedene Anwendungen (Ein- und Aufbau) - z.B für alle Frames BTICINO (2 Moduln) - ohne Einbaudose - LED Farbe kalt Weiß 6500K (CW) - naturell Weiß 4000K (NW) - warm Weiß 2800K (WW) - Blau (B) oder Grün (GR)

### 1635B.230V/.. - BRUNA voor frame bticino

~230V  IP20    0,0850  05.10.02 

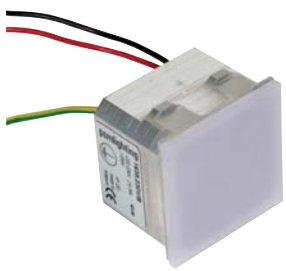

build-in wall light  
Einbau Wandleuchte

#### Lamptype

 led 230V . (1) 1,4W 230V

#### Dimensions

 L45xB45

#### Ref

1635B.230V.NW

*build-in*  
other IP level on request  
andere IP Wert auf Anfrage  
for bedrooms - less brightness  
für Schlafzimmer - weniger Lichtstärke

### 1635.230V/.. - BRUNA voor frame bticino

~230V  IP20    0,0720  05.10.02 

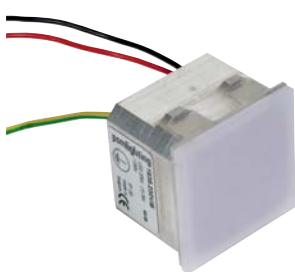

build-in wall light  
Einbau Wandleuchte

#### Lamptype

 led 230V . (1) 3W 230V

#### Dimensions

 L45xB45

#### Ref

1635.230V.CW  
1635.230V.NW  
1635.230V.WW  
1635.230V.B  
1635.230V.GR

*build-in*  
other IP level on request  
andere IP Wert auf Anfrage

### 1635.12V-AC/.. - BRUNA voor frame bticino

~12V-AC   IP20    0,0160  05.10.02 

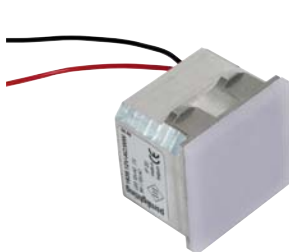

build-in wall light - alternating current - without transformer  
Einbau Wandleuchte - Wechselstrom - ohne Trafo

#### Lamptype

 led 12V-AC . (1) 3W 12V-AC

#### Dimensions

 L45xB45

#### Ref

1635.12V-AC.CW  
1635.12V-AC.NW  
1635.12V-AC.WW  
1635.12V-AC.B  
1635.12V-AC.GR

*build-in*  
other IP level on request  
andere IP Wert auf Anfrage

### 1635.12V-DC/.. - BRUNA voor frame bticino

=12V-DC   IP20    05.10.02 

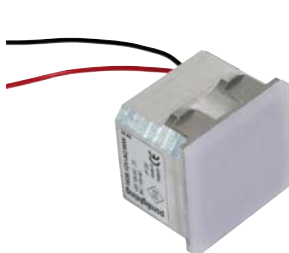

build-in wall light - direct current - without transformer  
Einbau Wandleuchte - Gleichstrom - ohne Trafo

#### Lamptype

 led 12V-DC . (1) 3W 12V-DC

#### Dimensions

 L45xB45

#### Ref

1635.12V-DC.CW  
1635.12V-DC.NW  
1635.12V-DC.WW  
1635.12V-DC.B  
1635.12V-DC.GR

*build-in*  
other IP level on request  
andere IP Wert auf Anfrage

## INDOOR | Led | BRUNA voor frame bticino

only convertible LED cassette for several applications (to build in and build up) - e.g. for all frames BTICINO (2 modules) - without build-in box - LED colour cold white 6500K (CW) - natural white 4000K (NW) - warm white 2800K (WW) - blue (B) or green (GR) - nur austauschbare LED Kassette für verschiedene Anwendungen (Ein- und Aufbau) - z.B für alle Frames BTICINO (2 Moduln) - ohne Einbaudose - LED Farbe kalt Weiß 6500K (CW) - naturell Weiß 4000K (NW) - warm Weiß 2800K (WW) - Blau (B) oder Grün (GR)

### 1635.24V-AC/.. - BRUNA voor frame bticino

~24V-AC IP20 05.10.02

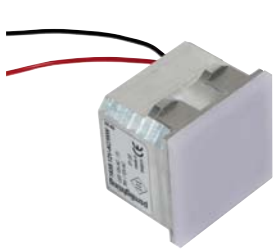

build-in wall light - alternating current - without transformer  
Einbau Wandleuchte - Wechselstrom - ohne Trafo

#### Lamp type

led 24V-AC . (1) 3W 24V-AC

#### Dimensions

L45xB45

#### Ref

1635.24V-AC.CW  
1635.24V-AC.NW  
1635.24V-AC.WW  
1635.24V-AC.B  
1635.24V-AC.GR

*build-in*  
other IP level on request  
andere IP Wert auf Anfrage

### 1635.24V-DC/.. - BRUNA voor frame bticino

=24V-DC IP20 05.10.02

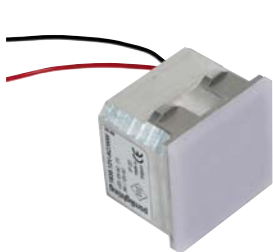

build-in wall light - direct current - without transformer  
Einbau Wandleuchte - Gleichstrom - ohne Trafo

#### Lamp type

led 24V-DC . (1) 3W 24V-DC

#### Dimensions

L45xB45

#### Ref

1635.24V-DC.CW  
1635.24V-DC.NW  
1635.24V-DC.WW  
1635.24V-DC.B  
1635.24V-DC.GR

*build-in*  
other IP level on request  
andere IP Wert auf Anfrage



## INDOOR | Led | BRUNA voor frame bticino

double convertible LED cassette for several applications (to build in and build up) - e.g. for all frames BTICINO (4 modules - not included) - without build-in box - LED colour cold white 6500K (CW) - natural white 4000K (NW) - warm white 2800K (WW) - blue (B) or Green (GR)

doppelte austauschbare LED Kassette für verschiedene Anwendungen (Ein- und Aufbau) - z.B für alle Frames BTICINO (4 Moduln - nicht einbegriffen) - ohne Einbaudose - LED Farbe kalt Weiß 6500K (CW) - naturell Weiß 4000K (NW) - warm Weiß 2800K (WW) - Blau (B) oder Grün (GR)

### 1636B.230V/.. - BRUNA voor frame bticino

~230V  IP20   05.10.02 

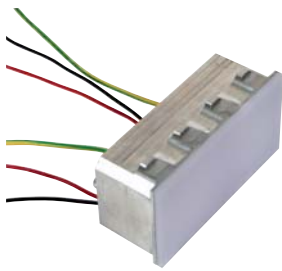

build-in wall light  
Einbau Wandleuchte

#### Lamptype

 led 230V . (2) 1,4W 230V

#### Dimensions

 L90xB45

#### Ref

1636B.230V.NW

**build-in**  
other IP level on request  
andere IP Wert auf Anfrage  
for bedrooms - less brightness  
für Schlafzimmer - weniger Lichtstärke

### 1636.230V/.. - BRUNA voor frame bticino

~230V  IP20   05.10.02 

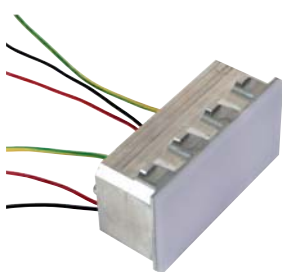

build-in wall light  
Einbau Wandleuchte

#### Lamptype

 led 230V . (2) 3W 230V

#### Dimensions

 L90xB45

#### Ref

1636.230V.CW  
1636.230V.NW  
1636.230V.WW  
1636.230V.B  
1636.230V.GR

**build-in**  
other IP level on request  
andere IP Wert auf Anfrage

### 1636.12V-AC/.. - BRUNA voor frame bticino

~12V-AC   IP20   05.10.02 

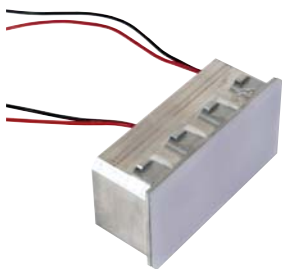

build-in wall light - alternating current - without transformer  
Einbau Wandleuchte - Wechselstrom - ohne Trafo

#### Lamptype

 led 12V-AC . (2) 3W 12V-AC

#### Dimensions

 L90xB45

#### Ref

1636.12V-AC.CW  
1636.12V-AC.NW  
1636.12V-AC.WW  
1636.12V-AC.B  
1636.12V-AC.GR

**build-in**  
other IP level on request  
andere IP Wert auf Anfrage

### 1636.12V-DC/.. - BRUNA voor frame bticino

=12V-DC   IP20   05.10.02 

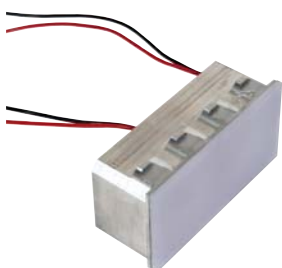

build-in wall light - direct current - without transformer  
Einbau Wandleuchte - Gleichstrom - ohne Trafo

#### Lamptype

 led 12V-DC . (2) 3W 12V-DC

#### Dimensions

 L90xB45

#### Ref

1636.12V-DC.CW  
1636.12V-DC.NW  
1636.12V-DC.WW  
1636.12V-DC.B  
1636.12V-DC.GR

**build-in**  
other IP level on request  
andere IP Wert auf Anfrage

## INDOOR | Led | BRUNA voor frame bticino

double convertible LED cassette for several applications (to build in and build up) - e.g. for all frames BTICINO (4 modules - not included) - without build-in box - LED colour cold white 6500K (CW) - natural white 4000K (NW) - warm white 2800K (WW) - blue (B) or Green (GR)

doppelte austauschbare LED Kassette für verschiedene Anwendungen (Ein- und Aufbau) - z.B für alle Frames BTICINO (4 Moduln - nicht einbegriffen) - ohne Einbaudose - LED Farbe kalt Weiß 6500K (CW) - naturell Weiß 4000K (NW) - warm Weiß 2800K (WW) - Blau (B) oder Grün (GR)

### 1636.24V-AC/.. - BRUNA voor frame bticino

~24V-AC IP20 05.10.02

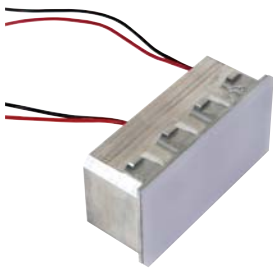

**bticino**

build-in wall light - alternating current - without transformer  
Einbau Wandleuchte - Wechselstrom - ohne Trafo

#### Lamp type

led 24V-AC . (2) 3W 24V-AC

#### Dimensions

L90xB45

#### Ref

1636.24V-AC.CW  
1636.24V-AC.NW  
1636.24V-AC.WW  
1636.24V-AC.B  
1636.24V-AC.GR

**build-in**  
other IP level on request  
andere IP Wert auf Anfrage

### 1636.24V-DC/.. - BRUNA voor frame bticino

=24V-DC IP20 05.10.02

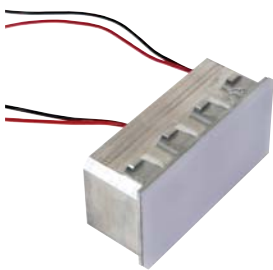

**bticino**

build-in wall light - direct current - without transformer  
Einbau Wandleuchte - Gleichstrom - ohne Trafo

#### Lamp type

led 24V-DC . (2) 3W 24V-DC

#### Dimensions

L90xB45

#### Ref

1636.24V-DC.CW  
1636.24V-DC.NW  
1636.24V-DC.WW  
1636.24V-DC.B  
1636.24V-DC.GR

**build-in**  
other IP level on request  
andere IP Wert auf Anfrage



## INDOOR | Led | DRIVER constant current

different types of LED drivers - pay attention to the maximum number of LEDs to connect!  
verschiedene Typen LED Drivers - achten Sie auf das Maximum an anzuschließen LEDs!

### 024CV350/.. - DRIVER constant current

IP65   



driver - 7,7W 350mA - for 6 LEDs x 1W - serial connection  
Driver - 7,7W 350mA - für 6 LEDs x 1W - Serienschaltung

Ref

024CV350

#### Dimensions

↔ L22xB25xH15



**build-in**  
lead-in voltage 24VDC  
Eingangsspannung 24VDC

### 024CV700/.. - DRIVER constant current

IP65   



driver - 15,4W 700mA - for 5 LEDs x 3W - serial connection  
Driver - 15,4W 700mA - für 5 LEDs x 3W - Serienschaltung

Ref

024CV700

#### Dimensions

↔ L22xB25xH15



**build-in**  
lead-in voltage 24VDC  
Eingangsspannung 24VDC

### 350PU004/.. - DRIVER constant current

IP65   



driver - 4,2W 350mA - for 3 LEDs x 1W - serial connection  
Driver - 4,2W 350mA - für 3 LEDs x 1W - Serienschaltung

Ref

350PU004

#### Dimensions

↔ L45xB45xH25

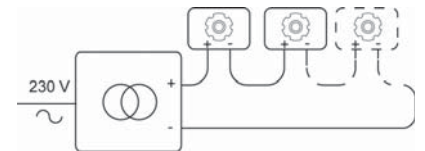

**build-in**

### 700PU004/.. - DRIVER constant current

IP65   



driver - 4,2W 700mA - for 1 LED x 3W - serial connection  
Driver - 4,2W 700mA - für 1 LED x 3W - Serienschaltung

Ref

700PU004

#### Dimensions

↔ L45xB45xH25

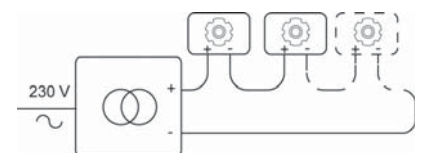

**build-in**



different types of LED drivers - pay attention to the maximum number of LEDs to connect!  
 verschiedene Typen LED Drivers - achten Sie auf das Maximum an anzuschließen LEDs!

**350PU008/.. - DRIVER constant current**

IP65   0,0600 



build-in

driver - 8,4W 350mA - for 6 LEDs x 1W - serial connection  
 Driver - 8,4W 350mA - für 6 LEDs x 1W - Serienschaltung

**Dimensions**

↔ L55xB40xH26

**Ref**

350PU008

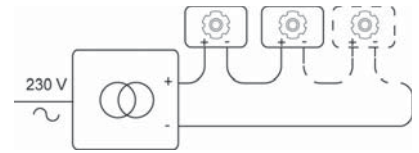

**700PU008/.. - DRIVER constant current**

IP65   0,0600 



build-in

driver - 8,4W 700mA - for 2 LEDs x 3W - serial connection  
 Driver - 8,4W 700mA - für 2 LEDs x 3W - Serienschaltung

**Dimensions**

↔ L55xB40xH26

**Ref**

700PU008

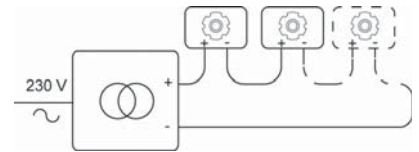

**LTLED1CC.350mA/.. - DRIVER constant current**

IP20  

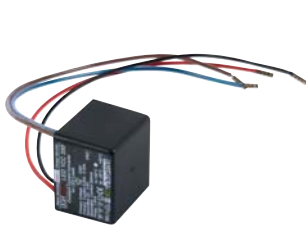

build-in



driver - 1W 350mA - for 1 LED x 1W - serial connection  
 Driver - 1W 350mA - für 1 LED x 1W - Serienschaltung

**Dimensions**

↔ L35xB35xH30

**Ref**

LTLED1CC.350mA

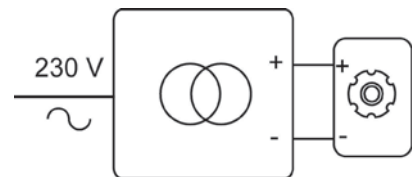

**LTLED4CC.350mA/.. - DRIVER constant current**

IP20  

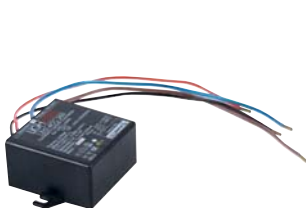

build-in



driver - 4W 350mA - for 3 LEDs x 1W - serial connection  
 Driver - 4W 350mA - für 3 LEDs x 1W - Serienschaltung

**Dimensions**

↔ L45xB45xH25

**Ref**

LTLED4CC.350mA

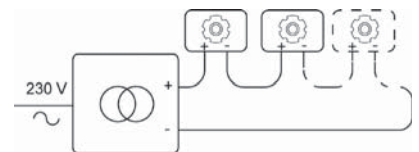

**INDOOR | Led | DRIVER constant current | DRIVER OT9/200-240/350 | DRIVER OT18/200-240/700**

different types of LED drivers - pay attention to the maximum number of LEDs to connect!  
 verschiedene Typen LED Drivers - achten Sie auf das Maximum an anzuschließen LEDs!

**LTLED6CC.350mA/.. - DRIVER constant current**

IP20   



driver - 6W 350mA - for 4 LEDs x 1W - serial connection  
 Driver - 6W 350mA - für 4 LEDs x 1W - Serienschaltung

**Dimensions**

↔ L45x845xH25

**Ref**

LTLED6CC.350mA

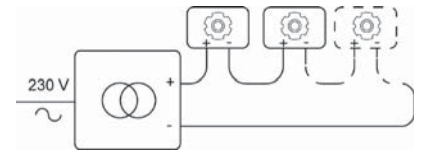

build-in

**LTLED6CC.700MA/.. - DRIVER constant current**

IP20   

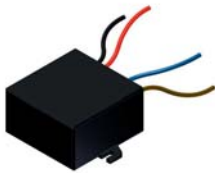

driver - 6W 700mA - for 2 LEDs x 3W - serial connection  
 Driver - 6W 700mA - für 2 LEDs x 3W - Serienschaltung

**Dimensions**

↔ L45x845xH25

**Ref**

LTLED6CC.700MA

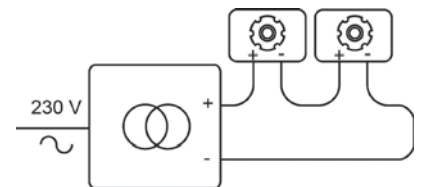

build-in

**OT9D.350MA/.. - DRIVER OT9/200-240/350**

IP20  



dimmable driver - 9W 350mA - for 6 LEDs x 1W - serial connection  
 abblendbarer Driver - 9W 350mA - für 6 LEDs x 1W - Serienschaltung

**Dimensions**

↔ L108x853xH33

**Ref**

OT9D.350MA

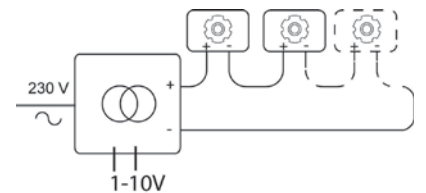

controller 1-10V  
 Regler 1-10V

**OT18D.700MA/.. - DRIVER OT18/200-240/700**

IP20   



dimmable driver - 18W 700mA - for 6 LEDs x 3W - serial connection  
 abblendbarer Driver - 18W 700mA - für 6 LEDs x 3W - Serienschaltung

**Dimensions**

↔ L108x853xH33

**Ref**

OT18D.700MA

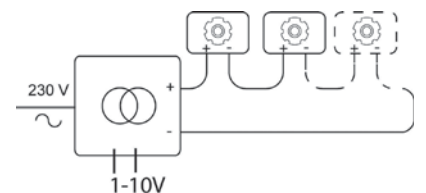

build-in  
 controller 1-10V  
 Regler 1-10V

## INDOOR | Led | DRIVER OT35/200-240/700 | DRIVER constant current

different types of LED drivers - pay attention to the maximum number of LEDs to connect!  
 verschiedene Typen LED Drivers - achten Sie auf das Maximum an anzuschließen LEDs!

### OT35.700MA/.. - DRIVER OT35/200-240/700

IP20   



driver - 35W 700mA - for 10 LEDs x 3W - serial connection  
 Driver - 35W 700mA - für 10 LEDs x 3W - Serienschaltung

**Dimensions**

↔ L190xB30xH21

**Ref**

OT35.700MA

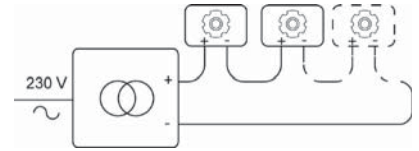

build-in

### PH350MADRIVER/.. - DRIVER constant current

IP20   



driver - 9137 006 158 - 12W 350mA - for 8 LEDs x 1W - serial connection  
 Driver - 9137 006 158 - 12W 350mA - für 8 LEDs x 1W - Serienschaltung

**Dimensions**

↔ L132xB34xH25

**Ref**

PH350MADRIVER

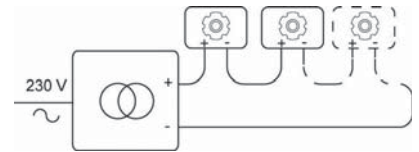

build-in

### VLMPTDCC15.350MA/.. - DRIVER constant current

IP20   

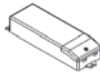

driver - 15W 350mA - for 12 LEDs x 1W - serial connection  
 Driver - 15W 350mA - für 12 LEDs x 1W - Serienschaltung

**Dimensions**

↔ L110xB40xH20

**Ref**

VLMPTDCC15.350MA

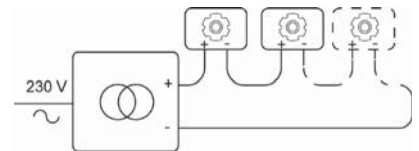

build-in

### VLMPTDCC15.700MA/.. - DRIVER constant current

IP20   

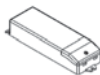

driver - 15W 700mA - for 5 LEDs x 3W - serial connection  
 Driver - 15W 700mA - für 5 LEDs x 3W - Serienschaltung

**Dimensions**

↔ L125xB40xH20

**Ref**

VLMPTDCC15.700MA

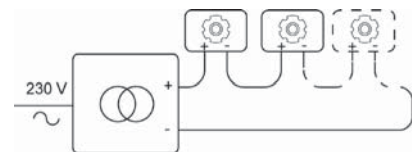

build-in

LED indoor

## INDOOR | Led | DRIVER constant current

different types of LED drivers - pay attention to the maximum number of LEDs to connect!  
verschiedene Typen LED Drivers - achten Sie auf das Maximum an anzuschließen LEDs!

### VLMPTDCC3.350MA/.. - DRIVER constant current

IP20  



driver - 3W 350mA - for 3 LEDs x 1W - serial connection  
Driver - 3W 350mA - für 3 LEDs x 1W - Serienschaltung

#### Dimensions

↔ L40xB40xH20

#### Ref

VLMPTDCC3.350MA

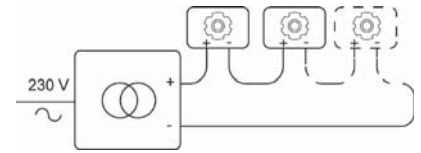

build-in

### VLMPTDCCD15.350MA/.. - DRIVER constant current

IP20  



dimnable driver - 15W 350mA - for 12 LEDs x 1W - serial connection - dimmable with push button  
abblendbarer Driver - 15W 350mA - für 12 LEDs x 1W - Serienschaltung - dimmbar mit Druckknopf

#### Dimensions

↔ L110xB70xH30

#### Ref

VLMPTDCCD15.350MA

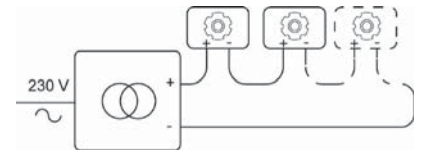

build-in

### VLMPTDCCR.350MA/.. - DRIVER constant current

IP20   



driver - 3W 350mA - for 3 LEDs x 1W - serial connection  
Driver - 3W 350mA - für 3 LEDs x 1W - Serienschaltung

#### Dimensions

↔ L50xB30xH20

#### Ref

VLMPTDCCR.350MA

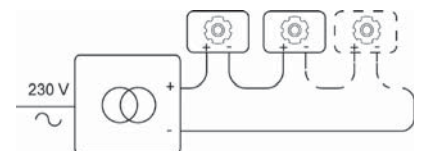

build-in

### VLMPTRDCC15.350MA/.. - DRIVER constant current

IP20  



driver - 15W 350mA - for 12 LEDs x 1W - serial connection  
Driver - 15W 350mA - für 12 LEDs x 1W - Serienschaltung

#### Dimensions

↔ Ø75xH25

#### Ref

VLMPTRDCC15.350MA

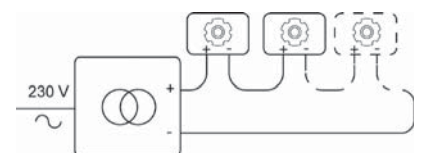

build-in

different types of LED drivers - pay attention to the maximum number of LEDs to connect!  
verschiedene Typen LED Drivers - achten Sie auf das Maximum an anzuschließen LEDs!

**VLMPTRDCC15.700MA/.. - DRIVER constant current**

IP20   0.0800 



driver - 15W 700mA - for 5 LEDs x 3W - serial connection  
Driver - 15W 700mA - für 5 LEDs x 3W - Serienschaltung

**Dimensions**

↔ Ø75xH25

**Ref**

VLMPTRDCC15.700MA

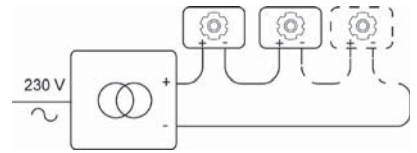

build-in



LED indoor

## INDOOR | Led | ECHO | ECHO SQ

LED colours: cold white (CW) or blue (B) - other LED colours on request  
LED Farben: kalt Weiß (CW) oder Blau (B) - andere LED Farben auf Anfrage

### 3085/.. - ECHO

=350mA



build-up ceiling or wall light - without LED driver  
Decken- oder Wandleuchte für Aufbau - ohne Driver LED

#### Ref

3085.14.CW

3085.14.B

#### Lamp type

powered 350mA . (1) 1W 350mA

#### Dimensions

Ø45xD25

build-up

### 3086/.. - ECHO SQ

=350mA



build-up ceiling or wall light - without LED driver  
Decken- oder Wandleuchte für Aufbau - ohne Driver LED

#### Ref

3086.14.CW

3086.14.B

#### Lamp type

powered 350mA . (1) 1W 350mA

#### Dimensions

B45xH45xD25

build-up



LED colours: cold white (CW) or blue (B) - other LED colours on request  
 LED Farben: kalt Weiß (CW) oder Blau (B) - andere LED Farben auf Anfrage

**W2400/././1LED - FUNGO**

=350mA IP44 0,5 m 05.10.02



build-up floor or wall light - without LED driver  
 Boden oder -Wandleuchte für Aufbau - ohne Driver LED

**Lamptype**  
 powered 350mA . (1) 1W 350mA

**Dimensions**  
 Ø95xH50  
 Ø70

**Ref**  
 W2400.14.CW.1LED  
 W2400.14.B.1LED  
 W2400.36.CW.1LED  
 W2400.36.B.1LED

build-up

**W2400/././2LED - FUNGO**

=350mA IP44 0,5 m 05.10.02



build-up floor or wall light - without LED driver  
 Boden oder -Wandleuchte für Aufbau - ohne Driver LED

**Lamptype**  
 powered 350mA . (2) 1W 350mA

**Dimensions**  
 Ø95xH50  
 Ø70

**Ref**  
 W2400.14.CW.2LED  
 W2400.14.B.2LED  
 W2400.36.CW.2LED  
 W2400.36.B.2LED

build-up

**W2400/././3LED - FUNGO**

=350mA IP44 0,5 m 05.10.02



build-up floor or wall light - without LED driver  
 Boden oder -Wandleuchte für Aufbau - ohne Driver LED

**Lamptype**  
 powered 350mA . (3) 1W 350mA

**Dimensions**  
 Ø95xH50  
 Ø70

**Ref**  
 W2400.14.CW.3LED  
 W2400.14.B.3LED  
 W2400.36.CW.3LED  
 W2400.36.B.3LED

build-up

**W2400/././4LED - FUNGO**

=350mA IP44 0,5 m 05.10.02



build-up floor or wall light - without LED driver  
 Boden oder -Wandleuchte für Aufbau - ohne Driver LED

**Lamptype**  
 powered 350mA . (4) 1W 350mA

**Dimensions**  
 Ø95xH50  
 Ø70

**Ref**  
 W2400.14.CW.4LED  
 W2400.14.B.4LED  
 W2400.36.CW.4LED  
 W2400.36.B.4LED

build-up

## INDOOR | Led | FOYER

LED colours: cold white (CW) or blue (B) - other LED colours on request  
 LED Farben: kalt Weiß (CW) oder Blau (B) - andere LED Farben auf Anfrage

### 3095.ZT/.. - FOYER

=350mA IP20 0,5 m 05.10.02



build-up wall light - without LED driver  
 Wandleuchte für Aufbau - ohne Driver LED

#### Ref

3095.ZT.14.CW

3095.ZT.14.B

#### Lamptype

powered 350mA . (2) 1W 350mA

#### Dimensions

B110xH45xD27

*build-up*

### 3095.MT/.. - FOYER

~230V IP20 0,2775 0,5 m 05.10.02



semi build-in and build-up wall light - with LED driver  
 Halbeinbau und Halbaufbau Wandleuchte - mit Driver LED

#### Ref

3095.MT.14.CW

3095.MT.14.B

#### Lamptype

powered 350mA . (2) 1W 350mA

#### Dimensions

B125xH60xD30

110x49 30

*semi build in/up  
 with build-in box  
 mit Einbaudose*

### 3096.ZT/.. - FOYER

=350mA IP20 0,5 m 05.10.02



build-up wall light - without LED driver  
 Wandleuchte für Aufbau - ohne Driver LED

#### Ref

3096.ZT.14.CW

3096.ZT.14.B

#### Lamptype

powered 350mA . (2) 1W 350mA

#### Dimensions

B110xH45xD27

*build-up*

### 3096.MT/.. - FOYER

~230V IP20 0,2775 0,5 m 05.10.02



semi build-in and build-up wall light - with LED driver  
 Halbeinbau und Halbaufbau Wandleuchte - mit Driver LED

#### Ref

3096.MT.14.CW

3096.MT.14.B

#### Lamptype

powered 350mA . (2) 1W 350mA

#### Dimensions

B125xH60xD30

110x49 30

*semi build in/up  
 with build-in box  
 mit Einbaudose*



LED colours: cold white (CW) or blue (B) - other LED colours on request  
 LED Farben: kalt Weiß (CW) oder Blau (B) - andere LED Farben auf Anfrage

**3081.10/.. - UNO**

=350mA III IP20 0,5 m 05.10.02 CE



build-up wall light - without LED driver  
 Wandleuchte für Aufbau - ohne Driver LED

Ref  
 3081.10.14.CW  
 3081.10.14.B

**Lamptype**  
 powered 350mA . (1) 1W 350mA

**Dimensions**  
 B45xH60xD60 10° reflector

*build-up  
 other °angle reflector on demand  
 andere °Winkel Reflektor auf Anfrage*

**3081.40/.. - UNO**

=350mA III IP20 0,5 m 05.10.02 CE



build-up wall light - without LED driver  
 Wandleuchte für Aufbau - ohne Driver LED

Ref  
 3081.40.14.CW  
 3081.40.14.B

**Lamptype**  
 powered 350mA . (1) 1W 350mA

**Dimensions**  
 B45xH60xD60 40° reflector

*build-up  
 other °angle reflector on demand  
 andere °Winkel Reflektor auf Anfrage*

**3082.10/.. - DUO**

~230V IP20 0,5 m 05.10.02 CE



build-up wall light - with LED driver  
 Wandleuchte für Aufbau - mit Driver LED

Ref  
 3082.10.14.CW  
 3082.10.14.B

**Lamptype**  
 powered 350mA . (2) 1W 350mA

**Dimensions**  
 B45xH104xD60 10° reflector

*build-up  
 other °angle reflector on demand  
 andere °Winkel Reflektor auf Anfrage*

**3082.40/.. - DUO**

~230V IP20 0,5 m 05.10.02 CE



build-up wall light - with LED driver  
 Wandleuchte für Aufbau - mit Driver LED

Ref  
 3082.40.14.CW  
 3082.40.14.B

**Lamptype**  
 powered 350mA . (2) 1W 350mA

**Dimensions**  
 B45xH104xD60 40° reflector

*build-up  
 other °angle reflector on demand  
 andere °Winkel Reflektor auf Anfrage*

## INDOOR | Led | DUO

LED colours: cold white (CW) or blue (B) - other LED colours on request  
LED Farben: kalt Weiß (CW) oder Blau (B) - andere LED Farben auf Anfrage

### W3082.10/.. - DUO

~230V



build-up wall light - with LED driver  
Wandleuchte für Aufbau - mit Driver LED

#### Lamptype

powered 350mA . (2) 1W 350mA

#### Dimensions

B45xH104xD60 10° reflector

#### Ref

W3082.10.36.CW

W3082.10.36.B

W3082.10.40.CW

W3082.10.40.B

**build-up**  
other °angle reflector on demand  
andere °Winkel Reflektor auf Anfrage

### W3082.40/.. - DUO

~230V



build-up wall light - with LED driver  
Wandleuchte für Aufbau - mit Driver LED

#### Lamptype

powered 350mA . (2) 1W 350mA

#### Dimensions

B45xH104xD60 40° reflector

#### Ref

W3082.40.36.CW

W3082.40.36.B

W3082.40.40.CW

W3082.40.40.B

**build-up**  
other °angle reflector on demand  
andere °Winkel Reflektor auf Anfrage



LED colours: cold white (CW) warm white (WW) or blue (B) - other LED colours on request  
 LED Farben: kalt Weiß (CW) warm Weiß (WW) oder Blau (B) - andere LED Farben auf Anfrage

**3077/.. /40 - PLUTO**

~230V   IP20    0.3533  0.5 m  05.10.02 





build-up wall light - with LED driver  
 Wandleuchte für Aufbau - mit Driver LED

**Lamp type**

 powered 700mA . (3) 3W 700mA

**Dimensions**

 B180xH120xD60  40° reflector  
 B155xH95

**Ref**

- 3077.1M.CW.40
- 3077.1M.WW.40
- 3077.1M.B.40
- 3077.14.CW.40
- 3077.14.WW.40
- 3077.14.B.40

*build-up  
 other °angle reflector on demand  
 andere °Winkel Reflektor auf Anfrage*

**3078/.. /40 - PLUTO**

~230V   IP20    0.1917  0.5 m  05.10.02 



build-up wall light - with LED driver  
 Wandleuchte für Aufbau - mit Driver LED

**Lamp type**

 powered 700mA . (2) 3W 700mA

**Dimensions**

 B120xH120xD60  40° reflector  
 B95xH95

**Ref**

- 3078.1M.CW.40
- 3078.1M.WW.40
- 3078.1M.B.40
- 3078.14.CW.40
- 3078.14.WW.40
- 3078.14.B.40

*build-up  
 other °angle reflector on demand  
 andere °Winkel Reflektor auf Anfrage*



## INDOOR | Led | BOLERO LED

LED colours: cold white (CW) warm white (WW) or naturel white (NW) - other LED colours on request

LED Farben: kalt Weiß (CW) warm Weiß (WW) oder naturell Weiß (NW) - andere LED Farben auf Anfrage

### W1096.LED/.. - BOLERO LED

~230V IP54 0.5 m 05.10.02



build-up wall light - down  
Wandleuchte für Aufbau - down

#### Lamptype

led 230V . (1) 3W 230V

#### Dimensions

B60xH40xD100

#### Ref

W1096.LED.1M.CW  
W1096.LED.1M.NW  
W1096.LED.1M.WW  
W1096.LED.10.CW  
W1096.LED.10.NW  
W1096.LED.10.WW  
W1096.LED.14.CW  
W1096.LED.14.NW  
W1096.LED.14.WW  
W1096.LED.21.CW  
W1096.LED.21.NW  
W1096.LED.21.WW  
W1096.LED.34.CW  
W1096.LED.34.NW  
W1096.LED.34.WW  
W1096.LED.36.CW  
W1096.LED.36.NW  
W1096.LED.36.WW  
W1096.LED.37.CW  
W1096.LED.37.NW  
W1096.LED.37.WW

build-up

### W1097.LED/.. - BOLERO LED

~230V IP54 0.5 m 05.10.02



build-up wall light - down sloping  
Wandleuchte für Aufbau - down schräg

#### Lamptype

led 230V . (1) 3W 230V

#### Dimensions

B60xH40xD110

#### Ref

W1097.LED.1M.CW  
W1097.LED.1M.NW  
W1097.LED.1M.WW  
W1097.LED.10.CW  
W1097.LED.10.NW  
W1097.LED.10.WW  
W1097.LED.14.CW  
W1097.LED.14.NW  
W1097.LED.14.WW  
W1097.LED.21.CW  
W1097.LED.21.NW  
W1097.LED.21.WW  
W1097.LED.34.CW  
W1097.LED.34.NW  
W1097.LED.34.WW  
W1097.LED.36.CW  
W1097.LED.36.NW  
W1097.LED.36.WW  
W1097.LED.37.CW  
W1097.LED.37.NW  
W1097.LED.37.WW

build-up

LED colour: cold white (CW) - other LED colours on request

LED Farbe: kalt Weiß (CW) - andere LED Farben auf Anfrage

**W1218A/.. - STONE LED**

~230V



IP54



build-in wall light  
Einbau Wandleuchte

**Lamp type**

led 230V . (1) 3W

230V

**Dimensions**

B60xH150xD55

130x53 56

**Ref**

W1218A.21.CW

W1218A.36.CW

W1218A.37.CW

W1218A.40.CW

*build-in  
for wooden and aluminium profiles  
für Holz- und Aluminiumprofile*

**W1218B/.. - STONE LED**

=24V-DC



IP54



build-in wall light - without transformer  
Einbau Wandleuchte - ohne Trafo

**Lamp type**

led 24V-DC . (1) 3W

24V-DC

**Dimensions**

B60xH150xD55

130x53 56

**Ref**

W1218B.21.CW

W1218B.36.CW

W1218B.37.CW

W1218B.40.CW

*build-in  
for wooden and aluminium profiles  
für Holz- und Aluminiumprofile*

## INDOOR | Led | MAMBO LED

LED colours: cold white (CW) or warm white (WW) - other LED colours on request  
LED Farben: kalt Weiß (CW) oder warm Weiß (WW) - andere LED Farben auf Anfrage

### 3028/.. - MAMBO LED

~230V  IP20    05.10.02 

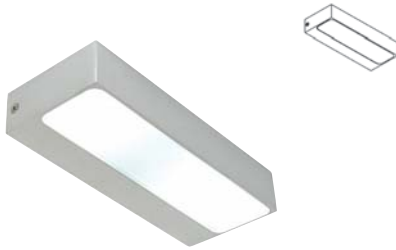

build-up wall light - down  
Wandleuchte für Aufbau - down

#### Lamp type

 led 230V . (2) 3W 230V

#### Dimensions

 B200xH35xD80

 L200xB35

#### Ref

3028.1M.CW  
3028.1M.WW  
3028.10.CW  
3028.10.WW  
3028.14.CW  
3028.14.WW  
3028.22.CW  
3028.22.WW

build-up

### 3029/.. - MAMBO LED

~230V  IP20    0.0938 05.10.02 



build-up wall light - up & down  
Wandleuchte für Aufbau - up & down

#### Lamp type

 led 230V . (3) 3W 230V

#### Dimensions

 B200xH35xD80

 L200xB35

#### Ref

3029.1M.CW  
3029.1M.WW  
3029.10.CW  
3029.10.WW  
3029.14.CW  
3029.14.WW  
3029.22.CW  
3029.22.WW

build-up

image of your preference should be delivered as a dxf/dwg file - LED colour cold white (CW) - other LED colours on request  
 gewünschte Figur soll in einer dxf/dwg Datei angeliefert werden - LED Farbe kalt Weiß (CW) - andere LED Farben auf Anfrage

1660/.. - PICTO

~230V IP20 05.10.02 CE



build-up

build-up wall light  
 Wandleuchte für Aufbau

Ref

1660.10.CW

1660.14.CW

Lamptype

led 230V . (1) 3W 230V

Dimensions

B40xH200xD40

B25xH183

1661/.. - PICTO

~230V IP20 05.10.02 CE



build-up

build-up wall light  
 Wandleuchte für Aufbau

Ref

1661.10.CW

1661.14.CW

Lamptype

led 230V . (1) 3W 230V

Dimensions

B200xH40xD40

B183xH25

1662/.. - PICTO

~230V IP20 05.10.02 CE



build-up

build-up wall light  
 Wandleuchte für Aufbau

Ref

1662.10.CW

1662.14.CW

Lamptype

led 230V . (1) 3W 230V

Dimensions

B40xH120xD40

B25xH103

1663/.. - PICTO

~230V IP20 05.10.02 CE



build-up

build-up wall light  
 Wandleuchte für Aufbau

Ref

1663.10.CW

1663.14.CW

Lamptype

led 230V . (1) 3W 230V

Dimensions





B120xH40xD40

B103xH25

## INDOOR | Led | PICTO | PICTO SENSOR | PICTO

image of your preference should be delivered as a dxf/dwg file - LED colour cold white (CW) - other LED colours on request  
 gewünschte Figur soll in einer dxf/dwg Datei angeliefert werden - LED Farbe kalt Weiß (CW) - andere LED Farben auf Anfrage

### W1663/.. - PICTO

~230V  IP54    



build-up wall light  
 Wandleuchte für Aufbau

Ref  
 W1663.36.CW

#### Lamptype

 led 230V . (1) 3W 230V

#### Dimensions

 B120xH40xD40

 B103xH25

build-up

### W1663.SEN/.. - PICTO SENSOR

~230V  IP54    



build-up wall light - with twilight switch  
 Wandleuchte für Aufbau - mit Dämmerungsschalter

Ref  
 W1663.SEN.36.CW

#### Lamptype

 led 230V . (1) 3W 230V





#### Dimensions

 B120xH40xD40

 B103xH25

build-up

### 1664A/.. - PICTO

~230V  IP20    



build-up wall light  
 Wandleuchte für Aufbau

Ref  
 1664A.10.CW  
 1664A.14.CW

#### Lamptype

 led 230V . (2) 3W 230V



#### Dimensions

 B400xH40xD40

 B382xH25

build-up

### 1664B/.. - PICTO

~230V  IP20    



build-up wall light  
 Wandleuchte für Aufbau

Ref  
 1664B.10.CW  
 1664B.14.CW

#### Lamptype

 led 230V . (3) 3W 230V

#### Dimensions

 B400xH40xD40

 B382xH25

build-up



image of your preference should be delivered as a dxf/dwg file - LED colour cold white (CW) - other LED colours on request  
 gewünschte Figur soll in einer dxf/dwg Datei angeliefert werden - LED Farbe kalt Weiß (CW) - andere LED Farben auf Anfrage

**W1664/.. - PICTO**

~230V  IP54    05.10.02 



build-up wall light  
 Wandleuchte für Aufbau

Ref  
 W1664.36.CW

**Lamptype**

 led 230V . (3) 3W 230V

**Dimensions**

 B400xH40xD40

 B382xH25

build-up

**W1664.SEN/.. - PICTO SENSOR**

~230V  IP54    05.10.02 



build-up wall light - with twilight switch  
 Wandleuchte für Aufbau - mit Dämmerungsschalter

Ref  
 W1664.SEN.36.CW

**Lamptype**

 led 230V . (3) 3W 230V

**Dimensions**

 B400xH40xD40

 B382xH25

build-up

## INDOOR | Led | ORKA WALL

LED colours: cold white (CW) or warm white (WW) - other LED colours on request  
 LED Farben: kalt Weiß (CW) oder warm Weiß (WW) - andere LED Farben auf Anfrage





### 3022A/.. - ORKA WALL ~230V IP20 0.5 m 05.10.02



build-in wall light - with switch - for Helia build-in box 275 or 276 (4 screws) - with LED driver  
 Einbau Wandleuchte - mit Schalter - für Helia Dose 275 oder 276 (4 Schrauben) - mit Driver LED

**Lamp type**  
 powered 700mA . (1) 3W 700mA

**Dimensions**  
 B80xH90  40° reflector

Ref
3022A.7.CW
3022A.7.WW
3022A.10.CW
3022A.10.WW
3022A.14.CW
3022A.14.WW
3022A.22.CW
3022A.22.WW
3022A.23.CW
3022A.23.WW



*build-in  
 other °angle reflector on demand  
 andere °Winkel Reflektor auf Anfrage*

### 3022B/.. - ORKA WALL ~230V IP20 0.5 m 05.10.02



build-in wall light - without switch - for build-in box Helia 275 or 276 (4 screws) - with LED driver  
 Einbau Wandleuchte - ohne Schalter - für Helia Dose 275 oder 276 (4 Schrauben) - mit Driver LED

**Lamp type**  
 powered 700mA . (1) 3W 700mA

**Dimensions**  
 B80xH90  40° reflector

Ref
3022B.7.CW
3022B.7.WW
3022B.10.CW
3022B.10.WW
3022B.14.CW
3022B.14.WW
3022B.22.CW
3022B.22.WW
3022B.23.CW
3022B.23.WW

*build-in  
 other °angle reflector on demand  
 andere °Winkel Reflektor auf Anfrage*

LED colours: cold white (CW) or warm white (WW) - other LED colours on request  
 LED Farben: kalt Weiß (CW) oder warm Weiß (WW) - andere LED Farben auf Anfrage

**3022C/.. - ORKA WALL**

~230V

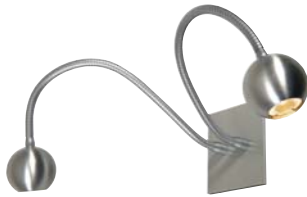

build-in wall light - without switch - for build-in box Helia 275 or 276 (4 screws) - with LED driver  
 Einbau Wandleuchte - ohne Schalter - für Helia Dose 275 oder 276 (4 Schrauben) - mit Driver LED

**Lamp type**

⚙️ powered 700mA . (2) 3W 700mA

**Dimensions**

↔️ B80xH90    ∟ 40° reflector

**Ref**

- 3022C.7.CW
- 3022C.7.WW
- 3022C.10.CW
- 3022C.10.WW
- 3022C.14.CW
- 3022C.14.WW
- 3022C.22.CW
- 3022C.22.WW
- 3022C.23.CW
- 3022C.23.WW

build-in  
 other °angle reflector on demand  
 andere °Winkel Reflektor auf Anfrage

**3088/.. /1W - ORKA (43M)**

=350mA



downlight with swivel - without LED driver  
 Einbaustrahler mit Kugelgelenk - ohne Driver LED

**Lamp type**

⚙️ powered 350mA . (1) 1,2W 350mA

**Dimensions**

↔️ Ø50xD53    ∟ 40° reflector

📏 Ø40    ⚓ 50

**Ref**

- 3088.1M.CW.1W
- 3088.1M.B.1W
- 3088.14.CW.1W
- 3088.14.B.1W

build-in  
 available as long as supplies last  
 verfügbar solange die Vorräte reichen

**3088/.. /3W - ORKA (43M)**

=700mA



downlight with swivel - without LED driver  
 Einbaustrahler mit Kugelgelenk - ohne Driver LED

**Lamp type**

⚙️ powered 700mA . (1) 3W 700mA

**Dimensions**

↔️ Ø50xD53    ∟ 40° reflector

📏 Ø40    ⚓ 50

**Ref**

- 3088.1M.CW.3W
- 3088.1M.WW.3W
- 3088.14.CW.3W
- 3088.14.WW.3W

build-in

**3021A/.. - ORKA WALL**

~230V



build-up wall light - with switch - with LED driver  
 Wandleuchte für Aufbau - mit Schalter - mit Driver LED

**Lamp type**

⚙️ powered 700mA . (1) 3W 700mA

**Dimensions**

↔️ B80xH100xD40    ∟ 40° reflector

📏 L90xB65

**Ref**

- 3021A.7.CW
- 3021A.7.WW
- 3021A.10.CW
- 3021A.10.WW
- 3021A.14.CW
- 3021A.14.WW
- 3021A.22.CW
- 3021A.22.WW
- 3021A.23.CW
- 3021A.23.WW

other °angle reflector on demand  
 andere °Winkel Reflektor auf Anfrage

# INDOOR | Led | ORKA WALL | ORKA TABLE | ORKA M10

LED colours: cold white (CW) or warm white (WW) - other LED colours on request  
 LED Farben: kalt Weiß (CW) oder warm Weiß (WW) - andere LED Farben auf Anfrage

## 3021B/.. - ORKA WALL

~230V   IP20   0.0714  0.5 m  05.10.02 



build-up wall light - without switch - with LED driver  
 Wandleuchte für Aufbau - ohne Schalter - mit Driver LED

### Ref

### Lamp type

 powered 700mA . (1) 3W 700mA

### Dimensions

 B80xH100xD40  40° reflector

 L90xB65

- 3021B.7.CW
- 3021B.7.WW
- 3021B.10.CW
- 3021B.10.WW
- 3021B.14.CW
- 3021B.14.WW
- 3021B.22.CW
- 3021B.22.WW
- 3021B.23.CW
- 3021B.23.WW

other °angle reflector on demand  
 andere °Winkel Reflektor auf Anfrage

## 3020/.. - ORKA TABLE

~230V   IP20     0.5 m  05.10.02 





table lamp - with switch - cable and plug - with LED driver  
 Tischleuchte - mit Schalter - Kabel und Stecker - mit Driver LED

### Ref

### Lamp type

 powered 700mA . (1) 3W 700mA

### Dimensions

 L110xB80xH40  40° reflector

 L90xB65

- 3020.7.CW
- 3020.7.WW
- 3020.10.CW
- 3020.10.WW
- 3020.14.CW
- 3020.14.WW
- 3020.22.CW
- 3020.22.WW
- 3020.23.CW
- 3020.23.WW

other °angle reflector on demand  
 andere °Winkel Reflektor auf Anfrage

## 3023/./... - ORKA M10

=700mA   IP20     0.5  05.10.02 





build-up spotlight LED M10 with flexible tube - without LED driver  
 Aufbaustrahler LED M10 mit flexibler Tube - ohne Driver LED

### Lamp type

 powered 700mA . (1) 3W 700mA

### Dimensions

 Ø50  40° reflector

Colour	3023.300/..	3023.400/..	3023.500/..
	H 300	H 400	H 500
7.CW			
7.WW			
10.CW			
10.WW			
14.CW			
14.WW			

build-up  
 other °angle reflector on demand  
 andere °Winkel Reflektor auf Anfrage

# INDOOR | Led | ORKA PENDEL B1 | ORKA PENDEL B3 | ORKA 9

LED colours: cold white (CW) or warm white (WW) - other LED colours on request  
 LED Farben: kalt Weiß (CW) oder warm Weiß (WW) - andere LED Farben auf Anfrage

## 3087/..B1 - ORKA PENDEL B1 ~230V IP20 0.5 m



pendant with swivel and build-up base - rod can be shortened - with LED driver  
 Pendelleuchte mit Kugelgelenk und Aufbaurosette - kürzbare Stange - mit Driver LED

**Lamptype**  
 powered 700mA . (1) 3W 700mA

**Dimensions**  
 Ø50  $\wedge$  40° reflector - Bar 800mm  
 Ø60xH90

Ref
3087.7.CW.B1
3087.7.WW.B1
3087.14.CW.B1
3087.14.WW.B1
3087.22.CW.B1
3087.22.WW.B1

other lengths available on request - other °angle reflector on demand  
 andere Längen auf Anfrage - andere °Winkel Reflektor auf Anfrage

## 3087/..B3 - ORKA PENDEL B3 =700mA IP20 0.5 m

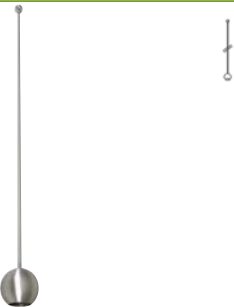

pendant with swivel - rod can be shortened - without LED driver  
 Pendelleuchte mit Kugelgelenk - kürzbare Stange - ohne Driver LED

**Lamptype**  
 powered 700mA . (1) 3W 700mA

**Dimensions**  
 Ø50  $\wedge$  40° reflector - Bar 800mm

Ref
3087.7.CW.B3
3087.7.WW.B3
3087.14.CW.B3
3087.14.WW.B3
3087.22.CW.B3
3087.22.WW.B3

other °angle reflector on demand  
 andere °Winkel Reflektor auf Anfrage

## 3089/.. - ORKA 9 ~230V IP20 0.5 m



ceiling light - rods 4x30cm - 4x40cm - 1x50cm - with LED driver  
 Deckenleuchte - Stangen 4x30cm - 4x40cm - 1x50cm - mit Driver LED

**Lamptype**  
 powered 700mA . (9) 3W 700mA

**Dimensions**  
 Ø350xH80  $\wedge$  40° reflector  
 Ø320xH25

Ref
3089.7.14.CW
3089.7.14.WW
3089.7.CW
3089.7.WW
3089.14.CW
3089.14.WW
3089.22.CW
3089.22.WW

other °angle reflector on demand  
 andere °Winkel Reflektor auf Anfrage

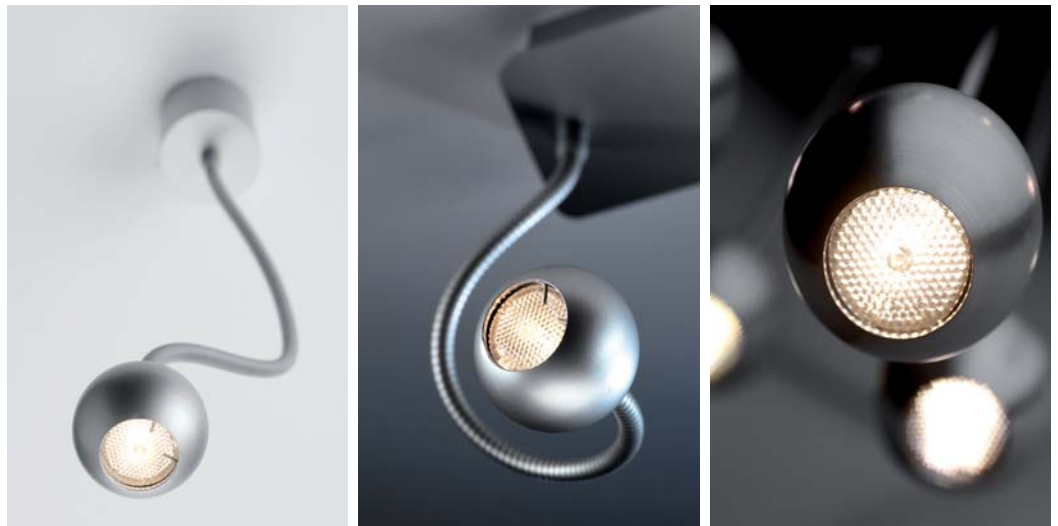

BUTTERFLY	436 - 446
CLIP	449 - 454
CLIP DOUBLE	456 - 462
CLIP SMALL	447, 448
CLIP WALL	462
LINEA	463
METRO	466 - 480
MIKADO	465
NEPTUNUS	481, 482
PALLADIO	482, 483
SLIDE	483
WING	484 - 486

**BUTTERFLY**



**CLIP SMALL**

2501/.. P.447



**CLIP**

2513/.. P.448



**CLIP + FORUM CLIP**

2548.A/.. P.450



2504.C/.. P.449



2516.A/.. P.451



**CLIP DOUBLE**

2532.A/.. P.456



2550.A/.. P.459



**LINEA**

2595/.. P.463



**MIKADO**

2601/.. P.465



2604/.. P.465



**METRO**

P.466



2100A/.. P.478



2108A/.. P.480



2125/.. P.480



**NEPTUNUS**

2720/.. P.481



2724/.. P.481



2727/.. P.482



**PALLADIO**

1530/.. P.482



**SLIDE**

1560/.. P.483



1561/.. P.483



**WING**

1544/.. P.484



1550/.. P.485



1551/.. P.485



1553/.. P.486



1554/.. P.486





## INDOOR | Profiles | BUTTERFLY

Butterfly, customised for your needs. A simple sketch is sufficient for a detailed proposal. Don't forget to mention the source: (T5 - MR16 - R7s etc...)  
Butterfly, maßgeschneidert auf Ihre Wünsche. Eine einfache Skizze mit Angabe des Leuchtmittels (T5 - MR16 - R7s etc...) genügt für ein komplettes, detailiertes Angebot.

### 2620/.. - BUTTERFLY

IP20  



accessories for lighting systems - per meter  
Zubehör für Lichtsysteme - pro Meter

Ref

2620.1  
2620.40

### 2621/.. - BUTTERFLY

IP20  



accessories for lighting systems - end plate  
Zubehör für Lichtsysteme - Endplatte

Ref

2621.1  
2621.40

### 2622/.. - BUTTERFLY

IP20  



accessories for lighting systems - end cap with switch  
Zubehör für Lichtsysteme - Endplatte mit Schalter

Ref

2622.1  
2622.40

### 2623/.. - BUTTERFLY

IP20  



accessories for lighting systems  
Zubehör für Lichtsysteme

Ref

2623.1  
2623.40



Butterfly, customised for your needs. A simple sketch is sufficient for a detailed proposal. Don't forget to mention the source: (T5 - MR16 - R7s etc...)  
 Butterfly, maßgeschneidert auf Ihre Wünsche. Eine einfache Skizze mit Angabe des Leuchtmittels (T5 - MR16 - R7s etc...) genügt für ein komplettes, detailiertes Angebot.

**2624/.. - BUTTERFLY**

IP20  

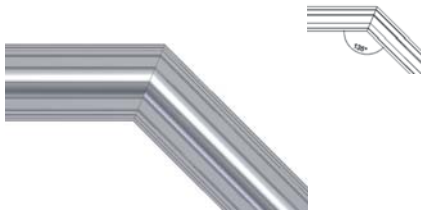

accessories for lighting systems - angle 135°  
 Zubehör für Lichtsysteme - Eckverbindung 135°

Ref  
 2624.1  
 2624.40

**2625/.. - BUTTERFLY**

IP20  



accessories for lighting systems - T-connector  
 Zubehör für Lichtsysteme - T-Verbindung

Ref  
 2625.1  
 2625.40

**2626/.. - BUTTERFLY**

IP20  

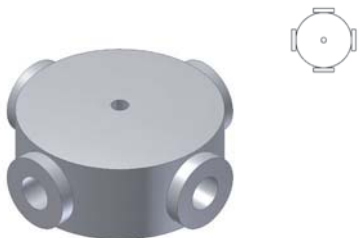

accessories for lighting systems - cross connector  
 Zubehör für Lichtsysteme - Kreuzverbindung

Ref  
 2626.1  
 2626.40

**2627/.. - BUTTERFLY**

IP20  



accessories for lighting systems - central suspension per piece + adaptor  
 Zubehör für Lichtsysteme - zentrale Abhängung pro Stück + Adapter

Ref  
 2627

height control on profile  
 Höheregelung auf Profil

## INDOOR | Profiles | BUTTERFLY

Butterfly, customised for your needs. A simple sketch is sufficient for a detailed proposal. Don't forget to mention the source: (T5 - MR16 - R7s etc...)  
Butterfly, maßgeschneidert auf Ihre Wünsche. Eine einfache Skizze mit Angabe des Leuchtmittels (T5 - MR16 - R7s etc...) genügt für ein komplettes, detailiertes Angebot.

### 2628/.. - BUTTERFLY

IP20  



accessories for lighting systems - sideways suspension price per set + fixation on profile  
Zubehör für Lichtsysteme - Seitenabhängung Preis pro Set + Befestigung an Profil

Ref  
2628

height control on ceiling  
Höheregelung auf der Decke

### 2629/.. - BUTTERFLY

IP20  



accessories for lighting systems - sideways suspension with bar  
Zubehör für Lichtsysteme - Seitenabhängung mit Balken

Ref  
2629

height control on ceiling  
Höheregelung auf der Decke

### 2630/.. - BUTTERFLY

IP20  



accessories for lighting systems - sideways suspension price per set + fixation on profile  
Zubehör für Lichtsysteme - Seitenabhängung Preis pro Set + Befestigung an Profil

Ref  
2630

height control on ceiling  
Höheregelung auf Profil

### 2631/.. - BUTTERFLY

IP20  



accessories for lighting systems - sideways suspension with bar + fixation on profile  
Zubehör für Lichtsysteme - Seitenabhängung mit Balken + Befestigung an Profil

Ref  
2631

height control on profile  
Höheregelung auf Profil

Butterfly, customised for your needs. A simple sketch is sufficient for a detailed proposal. Don't forget to mention the source: (T5 - MR16 - R7s etc...)  
 Butterfly, maßgeschneidert auf Ihre Wünsche. Eine einfache Skizze mit Angabe des Leuchtmittels (T5 - MR16 - R7s etc...) genügt für ein komplettes, detail-  
 liertes Angebot.

**2632/.. - BUTTERFLY**

IP20  

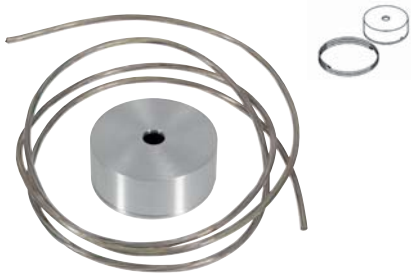

accessories for lighting systems - transparent cable 2m + base  
 005 - current supply 3x1  
 Zubehör für Lichtsysteme - transparentes Kabel 2m + Rosette  
 005 - Stromzuführung 3x1

Ref  
 2632

standard cabling 1 circuit  
 standard Verkabelung 1 Stromkreis

**2633/.. - BUTTERFLY**

IP20  



accessories for lighting systems - transparent cable 2m + base  
 005 - current supply 5x1  
 Zubehör für Lichtsysteme - transparentes Kabel 2m + Rosette  
 005 - Stromzuführung 5x1

Ref  
 2633

**Options**  
 SEXTRACIRCUIT/.. - CIRCUIT

standard cabling 1 circuit  
 standard Verkabelung 1 Stromkreis

**2634/.. - BUTTERFLY**

IP20   

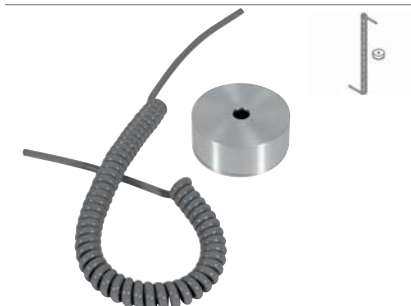

accessories for lighting systems - spiral wire 3 x G1 + base 005  
 Zubehör für Lichtsysteme - Spiralzuleitung 3 x G1 + Rosette  
 005

Ref  
 2634

40cm not stretched - standard cabling 1 circuit  
 40cm nicht ausgedehnt - standard Verkabelung 1  
 Stromkreis

**2635/.. - BUTTERFLY**

IP20  

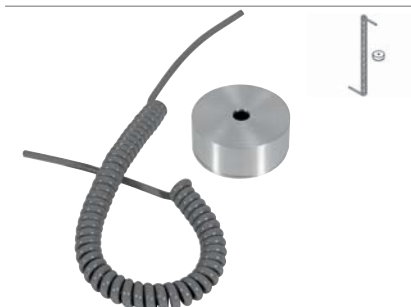

accessories for lighting systems - spiral wire 5 x G1 + base 005  
 Zubehör für Lichtsysteme - Spiralzuleitung 5 x G1 + Rosette  
 005

Ref  
 2635

**Options**  
 SEXTRACIRCUIT/.. - CIRCUIT

50cm not stretched - standard cabling 1 circuit  
 50cm nicht ausgedehnt - standard Verkabelung 1  
 Stromkreis

## INDOOR | Profiles | CIRCUIT | BUTTERFLY

Butterfly, customised for your needs. A simple sketch is sufficient for a detailed proposal. Don't forget to mention the source: (T5 - MR16 - R7s etc..)  
 Butterfly, maßgeschneidert auf Ihre Wünsche. Eine einfache Skizze mit Angabe des Leuchtmittels (T5 - MR16 - R7s etc..) genügt für ein komplettes, detailiertes Angebot.

### SEXTRACIRCUIT/.. - CIRCUIT







IP20  



accessories for lighting systems - cabling extra circuit  
 Zubehör für Lichtsysteme - Verkabelung zusätzlicher Stromkreis

Ref  
 SEXTRACIRCUIT

### T5 x 1/.. - BUTTERFLY

~230V   IP20    



accessories for lighting systems - with electronic gear  
 Zubehör für Lichtsysteme - mit elektronischem Vorschaltgerät

#### Lamptype

⇒ T16FH T5 G5 (1) 14W 230V

Reference	Length	Openings	Type of lamp
2637	600	0	T16FH T5 G5 (1) 14W / 230V
2638	600	0	T16FQ T5 G5 (1) 24W / 230V
2639	900	0	T16FH T5 G5 (1) 21W / 230V
2640	900	0	T16FQ T5 G5 (1) 39W / 230V
2641	1200	0	T16FH T5 G5 (1) 28W / 230V
2642	1200	0	T16FQ T5 G5 (1) 54W / 230V
2643	1500	0	T16FH T5 G5 (1) 35W / 230V
2644	1500	0	T16FQ T5 G5 (1) 49W / 230V
2645	1500	0	T16FQ T5 G5 (1) 80W / 230V

### T5 x 2/.. - BUTTERFLY

~230V   IP20    









accessories for lighting systems - with electronic gear  
 Zubehör für Lichtsysteme - mit elektronischem Vorschaltgerät

#### Lamptype

⇒ T16FH T5 G5 (2) 14W 230V

Reference	Length	Openings	Type of lamp
2646	600	0	T16FH T5 G5 (2) 14W / 230V
2647	600	0	T16FQ T5 G5 (2) 24W / 230V
2648	900	0	T16FH T5 G5 (2) 21W / 230V
2649	900	0	T16FQ T5 G5 (2) 39W / 230V
2650	1200	0	T16FH T5 G5 (2) 28W / 230V
2651	1200	0	T16FQ T5 G5 (2) 54W / 230V
2652	1500	0	T16FH T5 G5 (2) 35W / 230V
2653	1500	0	T16FQ T5 G5 (2) 49W / 230V

### T5 x 1SQ/.. - BUTTERFLY

~230V   IP20    

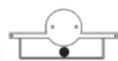

accessories for lighting systems - with electronic gear  
 Zubehör für Lichtsysteme - mit elektronischem Vorschaltgerät

#### Lamptype

⇒ T16FH T5 G5 (1) 14W 230V

Reference	Length	Openings	Type of lamp
2655	600	0	T16FH T5 G5 (1) 14W / 230V
2656	600	0	T16FQ T5 G5 (1) 24W / 230V
2657	900	0	T16FH T5 G5 (1) 21W / 230V
2658	900	0	T16FQ T5 G5 (1) 39W / 230V
2659	1200	0	T16FH T5 G5 (1) 28W / 230V
2660	1200	0	T16FQ T5 G5 (1) 54W / 230V
2661	1500	0	T16FH T5 G5 (1) 35W / 230V
2662	1500	0	T16FQ T5 G5 (1) 49W / 230V
2663	1500	0	T16FQ T5 G5 (1) 80W / 230V

Butterfly, customised for your needs. A simple sketch is sufficient for a detailed proposal. Don't forget to mention the source: (T5 - MR16 - R7s etc...)  
 Butterfly, maßgeschneidert auf Ihre Wünsche. Eine einfache Skizze mit Angabe des Leuchtmittels (T5 - MR16 - R7s etc...) genügt für ein komplettes, detail-  
 liertes Angebot.

**T5 X2SQ/.. - BUTTERFLY**

~230V  IP20  0,5 m  05.10.50 



accessories for lighting systems - with electronic gear  
 Zubehör für Lichtsysteme - mit elektronischem Vorschaltgerät

**Lamp type**

⇒ T16FH T5 G5 (2) 14W 230V

Reference	Length	Openings	Type of lamp
2664	600	0	T16FH T5 G5 (2) 14W / 230V
2665	600	0	T16FQ T5 G5 (2) 24W / 230V
2666	900	0	T16FH T5 G5 (2) 21W / 230V
2667	900	0	T16FQ T5 G5 (2) 39W / 230V
2668	1200	0	T16FH T5 G5 (2) 28W / 230V
2669	1200	0	T16FQ T5 G5 (2) 54W / 230V
2670	1500	0	T16FH T5 G5 (2) 35W / 230V
2671	1500	0	T16FQ T5 G5 (2) 49W / 230V

**SUPPLEMENT DIMABLE/.. - BUTTERFLY**

 IP20  

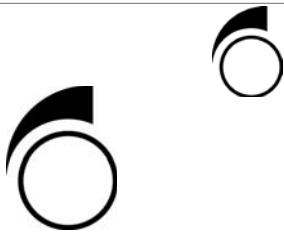

supplement - with electronic dimmable gear  
 Supplement - mit elektronischem abblendbarem  
 Vorschaltgerät

Reference	Length	Openings	Type of lamp
2682	600	0	
2683	900	0	
2684	600	0	
2685	900	0	
2686	1200	0	

**2689/.. - BUTTERFLY**

~12V   IP20  0,5 m  05.10.02 



accessories for lighting systems - module for fixed downlight  
 - without transformer  
 Zubehör für Lichtsysteme - Modul für festen Einbaustrahler  
 - ohne Trafo

**Ref**

2689

**Lamp type**

⇐ QR-CB 51 GU5,3/GX5,3 (1) 50W 12V

**2690/.. - BUTTERFLY**

~12V   IP20  0,5 m  05.10.02 



accessories for lighting systems - module for 2 fixed  
 downlights - without transformer  
 Zubehör für Lichtsysteme - Modul für 2 feste Einbaustrahler  
 - ohne Trafo

**Ref**

2690

**Lamp type**

⇐ QR-CB 51 GU5,3/GX5,3 (2) 50W 12V

## INDOOR | Profiles | BUTTERFLY

Butterfly, customised for your needs. A simple sketch is sufficient for a detailed proposal. Don't forget to mention the source: (T5 - MR16 - R7s etc...)  
 Butterfly, maßgeschneidert auf Ihre Wünsche. Eine einfache Skizze mit Angabe des Leuchtmittels (T5 - MR16 - R7s etc...) genügt für ein komplettes, detailiertes Angebot.

### 2695/.. - BUTTERFLY

~12V



accessories for lighting systems - 1x assembly spotlight  
 QR111 - without transformer  
 Zubehör für Lichtsysteme - 1x Montage Spot QR111 - ohne  
 Trafo

Ref

2695

#### Lamp type

QR-LP111 G53 (1) 50W 12V

### 2697/.. - BUTTERFLY

~230V

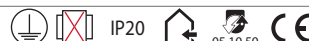

accessories for lighting systems - 1x assembly spotlight  
 CDM-R111 - without gear  
 Zubehör für Lichtsysteme - 1x Montage Spot CDM-R111 -  
 ohne Vorschaltgerät

Ref

2697

#### Lamp type

HIR-CE111 GX8,5 (1) 70W 230V

### 2693/.. - BUTTERFLY

IP20

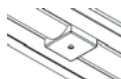

accessories for lighting systems - 1x assembly build-up  
 spotlight (not included)  
 Zubehör für Lichtsysteme - 1x Montage Aufbaustrahler (nicht  
 einbezogen)

Ref

2693

### 2696/.. - BUTTERFLY

~12V



accessories for lighting systems - 2x assembly spotlight  
 QR111 - without transformer  
 Zubehör für Lichtsysteme - 2x Montage Spot QR111 - ohne  
 Trafo

Ref

2696

#### Lamp type

QR-LP111 G53 (2) 50W 12V

Butterfly, customised for your needs. A simple sketch is sufficient for a detailed proposal. Don't forget to mention the source: (T5 - MR16 - R7s etc...)  
 Butterfly, maßgeschneidert auf Ihre Wünsche. Eine einfache Skizze mit Angabe des Leuchtmittels (T5 - MR16 - R7s etc...) genügt für ein komplettes, detail-  
 liertes Angebot.

**2698/.. - BUTTERFLY**

~230V   IP20   



accessories for lighting systems - 2x assembly spotlight  
 CDM-R111 - without gear  
 Zubehör für Lichtsysteme - 2x Montage Spot CDM-R111 -  
 ohne Vorschaltgerät

Ref  
 2698

**Lamp type**

 HIR-CE111 GX8,5 (2) 70W 230V

**2694/.. - BUTTERFLY**

IP20  

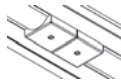

accessories for lighting systems - 2x assembly build-up  
 spotlight (not included)  
 Zubehör für Lichtsysteme - 2x Montage Aufbaustrahler (nicht  
 einbegriffen)

Ref  
 2694

**2705/.. - BUTTERFLY**

IP20  

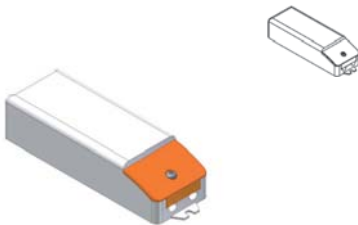

accessories for lighting systems - electronic transformer +  
 assembly  
 Zubehör für Lichtsysteme - elektronischer Trafo + Montage

Ref  
 2705

**Dimensions**

 L270

60VA - 12V

**2706/.. - BUTTERFLY**

IP20  

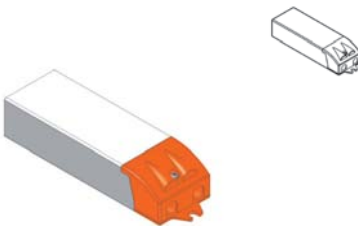

accessories for lighting systems - electronic transformer +  
 assembly  
 Zubehör für Lichtsysteme - elektronischer Trafo + Montage

Ref  
 2706

**Dimensions**

 L270

105VA - 12V

## INDOOR | Profiles | BUTTERFLY

Butterfly, customised for your needs. A simple sketch is sufficient for a detailed proposal. Don't forget to mention the source: (T5 - MR16 - R7s etc...)  
 Butterfly, maßgeschneidert auf Ihre Wünsche. Eine einfache Skizze mit Angabe des Leuchtmittels (T5 - MR16 - R7s etc...) genügt für ein komplettes, detailiertes Angebot.

### 2707/.. - BUTTERFLY

IP20  

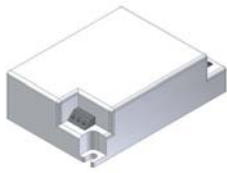

accessories for lighting systems - electronic gear + assembly  
 Zubehör für Lichtsysteme - elektronisches Vorschaltgerät + Montage

Ref  
 2707

CDM-R 35W

### 2708/.. - BUTTERFLY

IP20  



accessories for lighting systems - electronic gear + assembly  
 Zubehör für Lichtsysteme - elektronisches Vorschaltgerät + Montage

Ref  
 2708

CDM-R 70W

### 28../.. - BUTTERFLY

~230V   IP20    1,5 m  0,5 m  



lighting system - with electronic gear  
 Lichtsystem - mit elektronischem Vorschaltgerät

#### Lamp type

⇒ T16FQ T5 G5 (2) 24W 230V

Reference	Length	Openings	Type of lamp
2800.40	1100	0	T16FQ T5 G5 (2) 24W / 230V
2801.40	1400	0	T16FQ T5 G5 (2) 39W / 230V
2802.40	1700	0	T16FQ T5 G5 (2) 54W / 230V
2803.40	2000	0	T16FQ T5 G5 (2) 49W / 230V

### 280../.. - BUTTERFLY

~230V   IP20    1,5 m  0,5 m  



lighting system - with electronic gear  
 Lichtsystem - mit elektronischem Vorschaltgerät

#### Lamp type

⇒ T16FQ T5 G5 (2) 24W 230V

Reference	Length	Openings	Type of lamp
2804.40	1100	0	T16FQ T5 G5 (2) 24W / 230V
2805.40	1400	0	T16FQ T5 G5 (2) 39W / 230V
2806.40	1700	0	T16FQ T5 G5 (2) 54W / 230V
2807.40	2000	0	T16FQ T5 G5 (2) 49W / 230V



2809/.. - BUTTERFLY

~230V



build-up wall light - with magnetic gear  
Wandleuchte für Aufbau - mit magnetischem Vorschaltgerät

Ref  
2809.40

Lamptype

TC-S G23 (1) 9W 230V

Dimensions

B180xH258xD100

B130xH130

build-up

2810/.. - BUTTERFLY

~230V



build-up wall light - with transformer - with magnetic gear  
Wandleuchte für Aufbau - mit Trafo - mit magnetischem Vorschaltgerät

Ref  
2810.40

Lamptype

TC-S G23 (1) 9W 230V

QR-CB 51 coolfit GU5,3/GX5,3 (2) 50W 12V

Dimensions

B180xH258xD100

B130xH130

build-up  
105VA - use coolfit lamp  
Coolfit-Lampe verwenden

2811/.. - BUTTERFLY

~230V



build-up wall light - with magnetic gear  
Wandleuchte für Aufbau - mit magnetischem Vorschaltgerät

Ref  
2811.40

Lamptype

TC-S G23 (1) 11W 230V

Dimensions

B180xH358xD100

B130xH130

build-up

2813/.. - BUTTERFLY

~230V



build-up wall light - with transformer - with magnetic gear  
Wandleuchte für Aufbau - mit Trafo - mit magnetischem Vorschaltgerät

Ref  
2813.40

Lamptype

TC-S G23 (1) 11W 230V

QR-CB 51 coolfit GU5,3/GX5,3 (2) 50W 12V

Dimensions

B180xH308xD100

B130xH130

build-up  
105VA - use coolfit lamp  
Coolfit-Lampe verwenden

2812/.. - BUTTERFLY

~230V



build-up wall light - with transformer  
Wandleuchte für Aufbau - mit Trafo

Ref

2812.40

Lamp type

QR-CB 51 coolfit GU5,3/GX5,3 (2) 50W 12V

Dimensions

↔ B180xH200xD79

↕ B130xH130

build-up  
use coolfit lamp  
Coolfit-Lampe verwenden

2814/.. - BUTTERFLY

~230V



build-up wall light - with magnetic gear  
Wandleuchte für Aufbau - mit magnetischem Vorschaltgerät

Ref

2814.40

Lamp type

TC-S G23 (1) 11W 230V

Dimensions

↔ B180xH310xD160

build-up

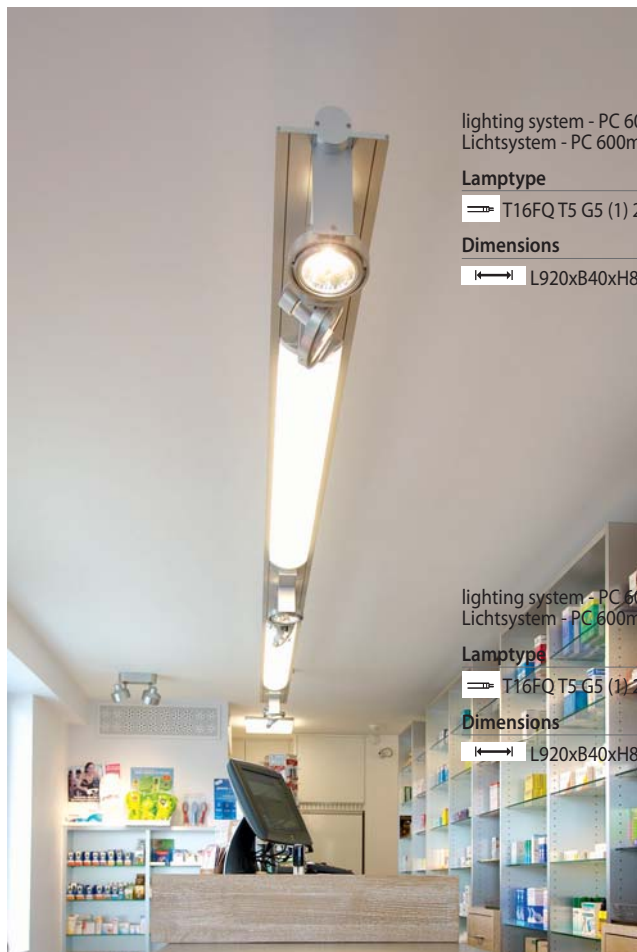

lighting system - PC 600mm - with electronic gear  
Lichtsystem - PC 600mm - mit elektronischem Vorschaltgerät

Ref

2501.40

Lamp type

T16FQ T5 G5 (1) 24W 230V

Dimensions

↔ L920xB40xH80



lighting system - PC 600mm - with electronic gear  
Lichtsystem - PC 600mm - mit elektronischem Vorschaltgerät

Ref

2511.40

Lamp type

T16FQ T5 G5 (1) 24W 230V

Dimensions

↔ L920xB40xH80



2501/.. - CLIP SMALL

~230V   IP20   0,5 m  05.10.50 

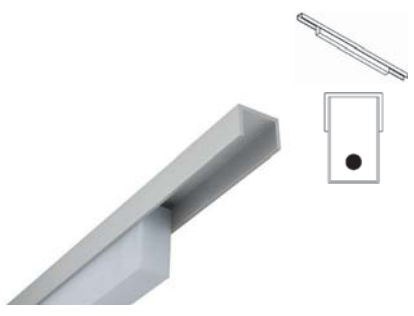

lighting system - PC 600mm - with electronic gear  
Lichtsystem - PC 600mm - mit elektronischem Vorschaltgerät

Ref  
2501.40

**Lamp type**  
⇒ T16FQ T5 G5 (1) 24W 230V

**Dimensions**  
↔ L920xB40xH80

2511/.. - CLIP SMALL

~230V   IP20    1,5 m  0,5 m  05.10.50 

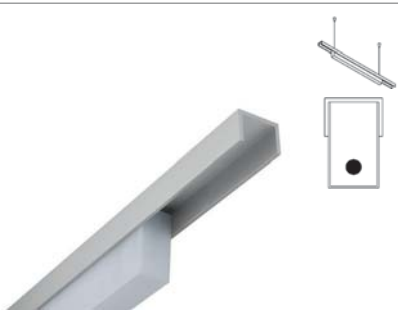

lighting system - PC 600mm - with electronic gear  
Lichtsystem - PC 600mm - mit elektronischem Vorschaltgerät

Ref  
2511.40

**Lamp type**  
⇒ T16FQ T5 G5 (1) 24W 230V

**Dimensions**  
↔ L920xB40xH80

2502/.. - CLIP SMALL

~230V  IP20   3,1250  0,5 m  

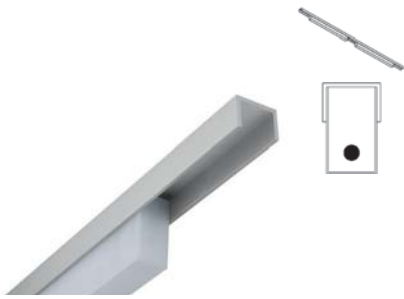

lighting system - PC 2 x 600mm - with electronic gear  
Lichtsystem - PC 2 x 600mm - mit elektronischem  
Vorschaltgerät

Ref  
2502.40

**Lamptype**  
⇒ T16FQ T5 G5 (2) 24W 230V

**Dimensions**  
↔ L1680xB40xH80

2512/.. - CLIP SMALL

~230V  IP20   1,5 m  0,5 m  

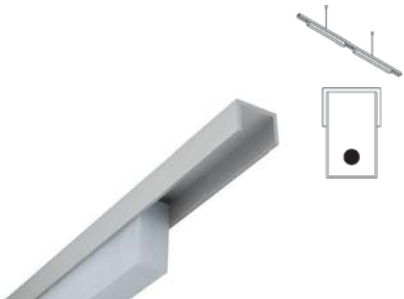

lighting system - PC 2 x 600mm - with electronic gear  
Lichtsystem - PC 2 x 600mm - mit elektronischem  
Vorschaltgerät

Ref  
2512.40

**Lamptype**  
⇒ T16FQ T5 G5 (2) 24W 230V

**Dimensions**  
↔ L1680xB40xH80

2503/.. - CLIP SMALL

~230V  IP20   0,5 m  

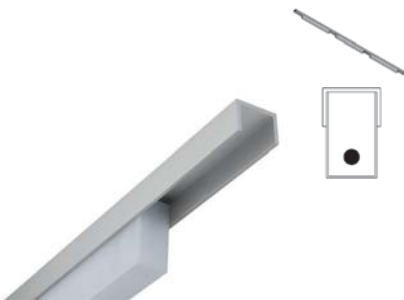

lighting system - PC 3 x 600mm - with electronic gear  
Lichtsystem - mit elektronischem Vorschaltgerät

Ref  
2503.40

**Lamptype**  
⇒ T16FQ T5 G5 (3) 24W 230V

**Dimensions**  
↔ L2440xB40xH80

2513/.. - CLIP SMALL

~230V  IP20   1,5 m  0,5 m  



lighting system - PC 3 x 600mm - with electronic gear  
Lichtsystem - mit elektronischem Vorschaltgerät

Ref  
2513.40

**Lamptype**  
⇒ T16FQ T5 G5 (3) 24W 230V

**Dimensions**  
↔ L2440xB40xH80

Clip, customised for your needs. A simple sketch is sufficient for a detailed proposal. Don't forget to mention the source: ( T5 - MR16 - R7s etc...)  
 Clip, maßgeschneidert auf Ihre Wünsche. Eine einfache Skizze mit Angabe des Leuchtmittels ( T5 - MR16 - R7s etc...) genügt für ein komplettes, detailliertes Angebot.

**2504.C/.. - CLIP**

~230V

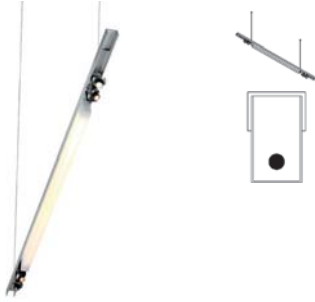

2x105VA

lighting system - PC 1500mm - with transformer - with electronic gear  
 Lichtsystem - PC 1500mm - mit Trafo - mit elektronischem Vorschaltgerät

**Ref**

2504.C.40

**Lamp type**

⇒ T16FH T5 G5 (1) 35W	230V
◁ QR-CB 51 GU5,3/GX5,3 (4) 50W	12V

**Dimensions**

↔ L2440xB60xH95

**2504.D/.. - CLIP**

~230V

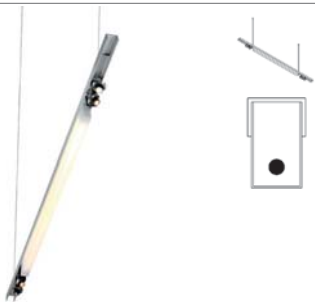

2x105VA

lighting system - PC 1500mm - with transformer - with electronic gear  
 Lichtsystem - PC 1500mm - mit Trafo - mit elektronischem Vorschaltgerät

**Ref**

2504.D.40

**Lamp type**

⇒ T16FQ T5 G5 (1) 49W	230V
◁ QR-CB 51 GU5,3/GX5,3 (4) 50W	12V

**Dimensions**

↔ L2440xB60xH95

**2514.A/.. - CLIP**

~230V



105VA

lighting system - PC 2 x 1200mm - with transformer - with electronic gear  
 Lichtsystem - PC 2 x 1200mm - mit Trafo - mit elektronischem Vorschaltgerät

**Ref**

2514.A.40

**Lamp type**

⇒ T16FH T5 G5 (2) 28W	230V
◁ QR-CB 51 GU5,3/GX5,3 (2) 50W	12V

**Dimensions**

↔ L3000xB60xH95

**2514.B/.. - CLIP**

~230V



105VA

lighting system - PC 2 x 1200mm - with transformer - with electronic gear  
 Lichtsystem - PC 2 x 1200mm - mit Trafo - mit elektronischem Vorschaltgerät

**Ref**

2514.B.40

**Lamp type**

⇒ T16FQ T5 G5 (2) 54W	230V
◁ QR-CB 51 GU5,3/GX5,3 (2) 50W	12V

**Dimensions**

↔ L3000xB60xH95

## INDOOR | Profiles | CLIP

Clip, customised for your needs. A simple sketch is sufficient for a detailed proposal. Don't forget to mention the source: (T5 - MR16 - R7s etc...)

Clip, maßgeschneidert auf Ihre Wünsche. Eine einfache Skizze mit Angabe des Leuchtmittels (T5 - MR16 - R7s etc...) genügt für ein komplettes, detailliertes Angebot.

### 2548.A/.. - CLIP

~230V   IP20    1,5 m  7,5400  0,5 m  05.10.50 

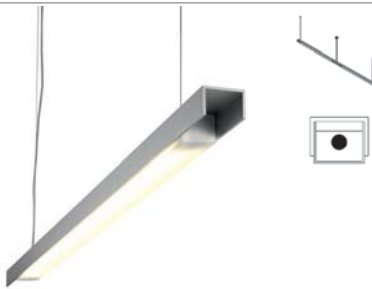

lighting system - PC 2 x 1200mm - with electronic gear  
Lichtsystem - PC 2 x 1200mm - mit elektronischem  
Vorschaltgerät

Ref

2548.A.40

#### Lamptype

⇒ T16FH T5 G5 (2) 28W 230V

#### Dimensions

↔ L3000xB60xH50

### 2548.B/.. - CLIP

~230V   IP20    1,5 m  7,5400  0,5 m  05.10.50 

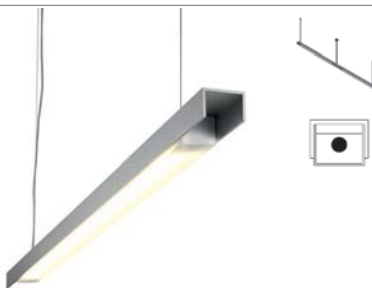

lighting system - PC 2 x 1200mm - with electronic gear  
Lichtsystem - PC 2 x 1200mm - mit elektronischem  
Vorschaltgerät

Ref

2548.B.40

#### Lamptype

⇒ T16FQ T5 G5 (2) 54W 230V

#### Dimensions

↔ L3000xB60xH50

### 2558.C/.. - CLIP

~230V   IP20    1,5 m  0,5 m  05.10.50 

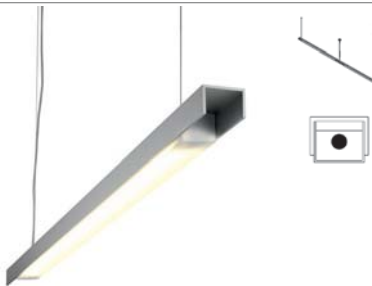

lighting system - PC 2 x 1500mm - with electronic gear  
Lichtsystem - PC 2 x 1500mm - mit elektronischem  
Vorschaltgerät

Ref

2558.C.40

#### Lamptype

⇒ T16FH T5 G5 (2) 35W 230V

#### Dimensions

↔ L3600xB60xH50

### 2558.D/.. - CLIP

~230V   IP20    1,5 m  0,5 m  05.10.50 

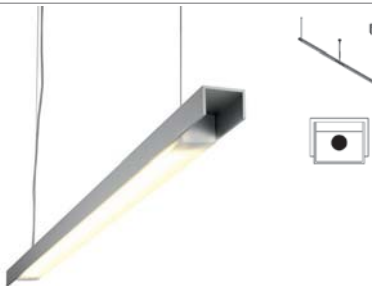

lighting system - PC 2 x 1500mm - with electronic gear  
Lichtsystem - PC 2 x 1500mm - mit elektronischem  
Vorschaltgerät

Ref

2558.D.40

#### Lamptype

⇒ T16FQ T5 G5 (2) 49W 230V

#### Dimensions

↔ L3600xB60xH50

Clip, customised for your needs. A simple sketch is sufficient for a detailed proposal. Don't forget to mention the source: ( T5 - MR16 - R7s etc...)

Clip, maßgeschneidert auf Ihre Wünsche. Eine einfache Skizze mit Angabe des Leuchtmittels ( T5 - MR16 - R7s etc...) genügt für ein komplettes, detailliertes Angebot.

**2516.A/.. - CLIP**

~230V   IP20    1,5 m  4,0500  0,5 m  05.10.50 



lighting system - PC 1200mm - with electronic gear  
Lichtsystem - PC 1200mm - mit elektronischem  
Vorschaltgerät

Ref

2516.A.40

**Lamptype**

⇒ T16FH T5 G5 (1) 28W 230V

**Dimensions**

↔ L1400xB60xH95

**2516.B/.. - CLIP**

~230V   IP20    1,5 m  4,0500  0,5 m  05.10.50 



lighting system - PC 1200mm - with electronic gear  
Lichtsystem - PC 1200mm - mit elektronischem  
Vorschaltgerät

Ref

2516.B.40

**Lamptype**

⇒ T16FQ T5 G5 (1) 54W 230V

**Dimensions**

↔ L1400xB60xH95

**2518.A/.. - CLIP**

~230V   IP20    1,5 m  0,5 m  05.10.50 



lighting system - PC 1200mm - with electronic gear  
Lichtsystem - PC 1200mm - mit elektronischem  
Vorschaltgerät

Ref

2518.A.40

**Lamptype**

⇒ T16FH T5 G5 (2) 28W 230V

**Dimensions**

↔ L1400xB60xH95

**2518.B/.. - CLIP**

~230V   IP20    1,5 m  4,6000  0,5 m  05.10.50 



lighting system - PC 1200mm - with electronic gear  
Lichtsystem - PC 1200mm - mit elektronischem  
Vorschaltgerät

Ref

2518.B.40

**Lamptype**

⇒ T16FQ T5 G5 (2) 54W 230V

**Dimensions**

↔ L1400xB60xH95

## INDOOR | Profiles | CLIP

Clip, customised for your needs. A simple sketch is sufficient for a detailed proposal. Don't forget to mention the source: (T5 - MR16 - R7s etc...)

Clip, maßgeschneidert auf Ihre Wünsche. Eine einfache Skizze mit Angabe des Leuchtmittels (T5 - MR16 - R7s etc...) genügt für ein komplettes, detailliertes Angebot.

### 2520.C/.. - CLIP

~230V



IP20



1,5 m



5,1050



0,5 m



05.10.50



lighting system - PC 1500mm - with electronic gear  
Lichtsystem - PC 1500mm - mit elektronischem  
Vorschaltgerät

Ref

2520.C.40

#### Lamptype

⇒ T16FH T5 G5 (1) 35W

230V

#### Dimensions

↔ L1700xB60xH95

### 2520.D/.. - CLIP

~230V



IP20



1,5 m



5,4650



0,5 m



05.10.50



lighting system - PC 1500mm - with electronic gear  
Lichtsystem - PC 1500mm - mit elektronischem  
Vorschaltgerät

Ref

2520.D.40

#### Lamptype

⇒ T16FQ T5 G5 (1) 49W

230V

#### Dimensions

↔ L1700xB60xH95

### 2522.C/.. - CLIP

~230V



IP20



1,5 m



5,4300



0,5 m



05.10.50



lighting system - PC 1500mm - with electronic gear  
Lichtsystem - PC 1500mm - mit elektronischem  
Vorschaltgerät

Ref

2522.C.40

#### Lamptype

⇒ T16FH T5 G5 (2) 35W

230V

#### Dimensions

↔ L1700xB60xH95

### 2522.D/.. - CLIP

~230V



IP20



1,5 m



5,3650



0,5 m



05.10.50



lighting system - PC 1500mm - with electronic gear  
Lichtsystem - PC 1500mm - mit elektronischem  
Vorschaltgerät

Ref

2522.D.40

#### Lamptype

⇒ T16FQ T5 G5 (2) 49W

230V

#### Dimensions

↔ L1700xB60xH95



Clip, customised for your needs. A simple sketch is sufficient for a detailed proposal. Don't forget to mention the source: ( T5 - MR16 - R7s etc...)

Clip, maßgeschneidert auf Ihre Wünsche. Eine einfache Skizze mit Angabe des Leuchtmittels ( T5 - MR16 - R7s etc...) genügt für ein komplettes, detailliertes Angebot.

**2524.A/.. - CLIP**

~230V



IP20



1,5 m



0,5 m



05.10.50

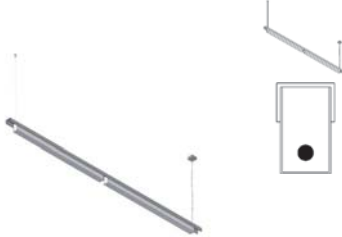

lighting system - PC 2 x 1200mm - with electronic gear  
 Lichtsystem - PC 2 x 1200mm - mit elektronischem  
 Vorschaltgerät

**Ref**

2524.A.40

**Lamptype**

⇒ T16FH T5 G5 (2) 28W 230V

**Dimensions**

↔ L2660xB60xH95

**2524.B/.. - CLIP**

~230V



IP20



1,5 m



0,5 m



05.10.50

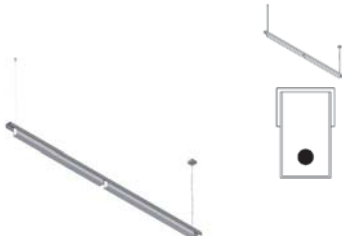

lighting system - PC 2 x 1200mm - with electronic gear  
 Lichtsystem - PC 2 x 1200mm - mit elektronischem  
 Vorschaltgerät

**Ref**

2524.B.40

**Lamptype**

⇒ T16FQ T5 G5 (2) 54W 230V

**Dimensions**

↔ L2660xB60xH95

**2526.A/.. - CLIP**

~230V



IP20



1,5 m



0,5 m



05.10.50

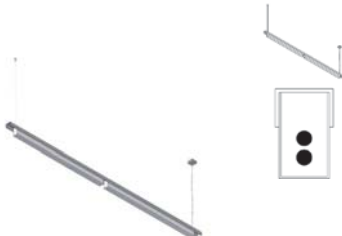

lighting system - PC 2 x 1200mm - with electronic gear  
 Lichtsystem - PC 2 x 1200mm - mit elektronischem  
 Vorschaltgerät

**Ref**

2526.A.40

**Lamptype**

⇒ T16FH T5 G5 (4) 28W 230V

**Dimensions**

↔ L2660xB60xH95

**2526.B/.. - CLIP**

~230V



IP20



1,5 m



0,5 m



05.10.50



lighting system - PC 2 x 1200mm - with electronic gear  
 Lichtsystem - PC 2 x 1200mm - mit elektronischem  
 Vorschaltgerät

**Ref**

2526.B.40

**Lamptype**

⇒ T16FQ T5 G5 (4) 54W 230V

**Dimensions**

↔ L2660xB60xH95

## INDOOR | Profiles | CLIP

Clip, customised for your needs. A simple sketch is sufficient for a detailed proposal. Don't forget to mention the source: (T5 - MR16 - R7s etc...)

Clip, maßgeschneidert auf Ihre Wünsche. Eine einfache Skizze mit Angabe des Leuchtmittels (T5 - MR16 - R7s etc...) genügt für ein komplettes, detailliertes Angebot.

### 2528.C/.. - CLIP

~230V



IP20



1,5 m



0,5 m



05.10.50



lighting system - PC 2 x 1500mm - with electronic gear  
Lichtsystem - PC 2 x 1500mm - mit elektronischem  
Vorschaltgerät

Ref

2528.C.40

#### Lamp type

⇒ T16FH T5 G5 (2) 35W

230V

#### Dimensions

↔ L3260xB60xH95

### 2528.D/.. - CLIP

~230V



IP20



1,5 m



0,5 m



05.10.50

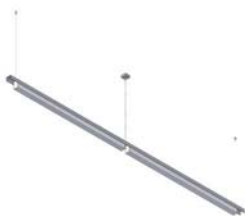

lighting system - PC 2 x 1500mm - with electronic gear  
Lichtsystem - PC 2 x 1500mm - mit elektronischem  
Vorschaltgerät

Ref

2528.D.40

#### Lamp type

⇒ T16FQ T5 G5 (2) 49W

230V

#### Dimensions

↔ L3260xB60xH95

### 2530.C/.. - CLIP

~230V



IP20



1,5 m



10,3000



0,5 m



05.10.50



lighting system - PC 2 x 1500mm - with electronic gear  
Lichtsystem - PC 2 x 1500mm - mit elektronischem  
Vorschaltgerät

Ref

2530.C.40

#### Lamp type

⇒ T16FH T5 G5 (4) 35W

230V

#### Dimensions

↔ L3260xB60xH95

### 2530.D/.. - CLIP

~230V



IP20



1,5 m



10,1900



0,5 m



05.10.50



lighting system - PC 2 x 1500mm - with electronic gear  
Lichtsystem - PC 2 x 1500mm - mit elektronischem  
Vorschaltgerät

Ref

2530.D.40

#### Lamp type

⇒ T16FQ T5 G5 (4) 49W

230V

#### Dimensions

↔ L3260xB60xH95

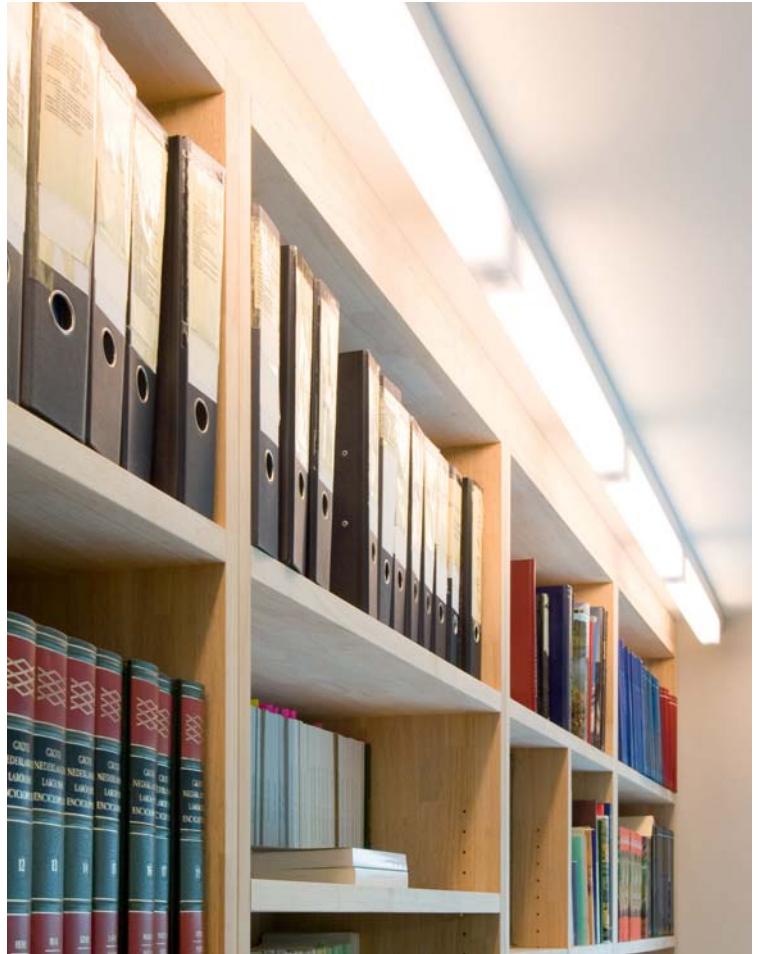

Profiles indoor

## INDOOR | Profiles | CLIP DOUBLE

Clip, customised for your needs. A simple sketch is sufficient for a detailed proposal. Don't forget to mention the source: (T5 - MR16 - R7s etc...)

Clip, maßgeschneidert auf Ihre Wünsche. Eine einfache Skizze mit Angabe des Leuchtmittels (T5 - MR16 - R7s etc...) genügt für ein komplettes, detailliertes Angebot.

### 2532.A/.. - CLIP DOUBLE

~230V



IP20



1,5 m



0,5 m



05.10.50



lighting system - PC 1200mm - with electronic gear  
Lichtsystem - PC 1200mm - mit elektronischem  
Vorschaltgerät

Ref

2532.A.40

#### Lamptype

⇒ T16FH T5 G5 (1) 28W

230V

#### Dimensions

↔ L1400xB60xH92

### 2532.B/.. - CLIP DOUBLE

~230V



IP20



1,5 m



0,5 m



05.10.50



lighting system - PC 1200mm - with electronic gear  
Lichtsystem - PC 1200mm - mit elektronischem  
Vorschaltgerät

Ref

2532.B.40

#### Lamptype

⇒ T16FQ T5 G5 (1) 54W

230V

#### Dimensions

↔ L1400xB60xH92

### 2534.A/.. - CLIP DOUBLE

~230V



IP20



1,5 m



0,5 m



05.10.50



lighting system - PC 1200mm - with electronic gear  
Lichtsystem - PC 1200mm - mit elektronischem  
Vorschaltgerät

Ref

2534.A.40

#### Lamptype

⇒ T16FH T5 G5 (2) 28W

230V

#### Dimensions

↔ L1400xB60xH92

### 2534.B/.. - CLIP DOUBLE

~230V



IP20



1,5 m



0,5 m



05.10.50



lighting system - PC 1200mm - with electronic gear  
Lichtsystem - PC 1200mm - mit elektronischem  
Vorschaltgerät

Ref

2534.B.40

#### Lamptype

⇒ T16FQ T5 G5 (2) 54W

230V

#### Dimensions

↔ L1400xB60xH92

Clip, customised for your needs. A simple sketch is sufficient for a detailed proposal. Don't forget to mention the source: (T5 - MR16 - R7s etc...)

Clip, maßgeschneidert auf Ihre Wünsche. Eine einfache Skizze mit Angabe des Leuchtmittels (T5 - MR16 - R7s etc...) genügt für ein komplettes, detailliertes Angebot.

**2536.A/.. - CLIP DOUBLE**

~230V

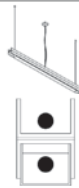

lighting system - PC 1200mm - with electronic gear  
Lichtsystem - PC 1200mm - mit elektronischem  
Vorschaltgerät

Ref

2536.A.40

**Lamp type**

⇒ T16FH T5 G5 (2) 28W 230V

**Dimensions**

↔ L1400xB60xH92

**2536.B/.. - CLIP DOUBLE**

~230V

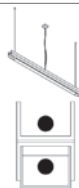

lighting system - PC 1200mm - with electronic gear  
Lichtsystem - PC 1200mm - mit elektronischem  
Vorschaltgerät

Ref

2536.B.40

**Lamp type**

⇒ T16FQ T5 G5 (2) 54W 230V

**Dimensions**

↔ L1400xB60xH92

**2538.A/.. - CLIP DOUBLE**

~230V

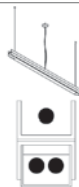
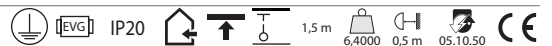

lighting system - PC 1200mm - with electronic gear  
Lichtsystem - PC 1200mm - mit elektronischem  
Vorschaltgerät

Ref

2538.A.40

**Lamp type**

⇒ T16FH T5 G5 (3) 28W 230V

**Dimensions**

↔ L1400xB60xH92

**2540.C/.. - CLIP DOUBLE**

~230V

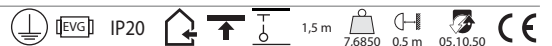

lighting system - PC 1500mm - with electronic gear  
Lichtsystem - PC 1500mm - mit elektronischem  
Vorschaltgerät

Ref

2540.C.40

**Lamp type**

⇒ T16FH T5 G5 (1) 35W 230V

**Dimensions**

↔ L1700xB60xH92

## INDOOR | Profiles | CLIP DOUBLE

Clip, customised for your needs. A simple sketch is sufficient for a detailed proposal. Don't forget to mention the source: ( T5 - MR16 - R7s etc...)

Clip, maßgeschneidert auf Ihre Wünsche. Eine einfache Skizze mit Angabe des Leuchtmittels ( T5 - MR16 - R7s etc...) genügt für ein komplettes, detailliertes Angebot.

### 2540.D/.. - CLIP DOUBLE

~230V



IP20



1,5 m



0,5 m



05.10.50



lighting system - PC 1500mm - with electronic gear  
Lichtsystem - PC 1500mm - mit elektronischem  
Vorschaltgerät

Ref

2540.D.40

#### Lamp type

⇒ T16FQ T5 G5 (1) 49W

230V

#### Dimensions

↔ L1700xB60xH92

### 2542.C/.. - CLIP DOUBLE

~230V



IP20



1,5 m



0,5 m



05.10.50



lighting system - PC 1500mm - with electronic gear  
Lichtsystem - PC 1500mm - mit elektronischem  
Vorschaltgerät

Ref

2542.C.40

#### Lamp type

⇒ T16FH T5 G5 (2) 35W

230V

#### Dimensions

↔ L1700xB60xH92

### 2542.D/.. - CLIP DOUBLE

~230V



IP20



1,5 m



0,5 m



05.10.50



lighting system - PC 1500mm - with electronic gear  
Lichtsystem - PC 1500mm - mit elektronischem  
Vorschaltgerät

Ref

2542.D.40

#### Lamp type

⇒ T16FQ T5 G5 (2) 49W

230V

#### Dimensions

↔ L1700xB60xH92

### 2544.C/.. - CLIP DOUBLE

~230V



IP20



1,5 m



0,5 m



05.10.50



lighting system - PC 1500mm - with electronic gear  
Lichtsystem - PC 1500mm - mit elektronischem  
Vorschaltgerät

Ref

2544.C.40

#### Lamp type

⇒ T16FH T5 G5 (2) 35W

230V

#### Dimensions

↔ L1700xB60xH92

Clip, customised for your needs. A simple sketch is sufficient for a detailed proposal. Don't forget to mention the source: (T5 - MR16 - R7s etc...)

Clip, maßgeschneidert auf Ihre Wünsche. Eine einfache Skizze mit Angabe des Leuchtmittels (T5 - MR16 - R7s etc...) genügt für ein komplettes, detailliertes Angebot.

**2546.C/.. - CLIP DOUBLE**

~230V   IP20    1,5 m  7,6800  0,5 m  05.10.50 

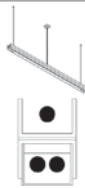

lighting system - PC 1500mm - with electronic gear  
Lichtsystem - PC 1500mm - mit elektronischem  
Vorschaltgerät

**Ref**

2546.C.40

**Lamptype**

⇒ T16FH T5 G5 (3) 35W 230V

**Dimensions**

↔ L1700xB60xH92

**2550.A/.. - CLIP DOUBLE**

~230V   IP20    1,5 m  0,5 m  05.10.50 



lighting system - PC 2 x 1200mm - with electronic gear  
Lichtsystem - PC 2 x 1200mm - mit elektronischem  
Vorschaltgerät

**Ref**

2550.A.40

**Lamptype**

⇒ T16FH T5 G5 (2) 28W 230V

**Dimensions**

↔ L2660xB60xH92

**2550.B/.. - CLIP DOUBLE**

~230V   IP20    1,5 m  0,5 m  05.10.50 



lighting system - PC 2 x 1200mm - with electronic gear  
Lichtsystem - PC 2 x 1200mm - mit elektronischem  
Vorschaltgerät

**Ref**

2550.B.40

**Lamptype**

⇒ T16FQ T5 G5 (2) 54W 230V

**Dimensions**

↔ L2660xB60xH92

**2552.A/.. - CLIP DOUBLE**

~230V   IP20    1,5 m  0,5 m  05.10.50 



lighting system - PC 2 x 1200mm - with electronic gear  
Lichtsystem - PC 2 x 1200mm - mit elektronischem  
Vorschaltgerät

**Ref**

2552.A.40

**Lamptype**

⇒ T16FH T5 G5 (4) 28W 230V

**Dimensions**

↔ L2660xB60xH92

## INDOOR | Profiles | CLIP DOUBLE

Clip, customised for your needs. A simple sketch is sufficient for a detailed proposal. Don't forget to mention the source: ( T5 - MR16 - R7s etc...)

Clip, maßgeschneidert auf Ihre Wünsche. Eine einfache Skizze mit Angabe des Leuchtmittels ( T5 - MR16 - R7s etc...) genügt für ein komplettes, detailliertes Angebot.

### 2552.B/.. - CLIP DOUBLE

~230V



IP20



1,5 m



0,5 m



05.10.50



lighting system - PC 2 x 1200mm - with electronic gear  
Lichtsystem - PC 2 x 1200mm - mit elektronischem  
Vorschaltgerät

Ref

2552.B.40

#### Lamptype

⇒ T16FQ T5 G5 (4) 54W 230V

#### Dimensions

↔ L2660xB60xH92

### 2554.A/.. - CLIP DOUBLE

~230V



IP20



1,5 m



0,5 m



05.10.50



lighting system - PC 2 x 1200mm - with electronic gear  
Lichtsystem - PC 2 x 1200mm - mit elektronischem  
Vorschaltgerät

Ref

2554.A.40

#### Lamptype

⇒ T16FH T5 G5 (4) 28W 230V

#### Dimensions

↔ L2660xB60xH92

### 2554.B/.. - CLIP DOUBLE

~230V



IP20



1,5 m



0,5 m



05.10.50



lighting system - PC 2 x 1200mm - with electronic gear  
Lichtsystem - PC 2 x 1200mm - mit elektronischem  
Vorschaltgerät

Ref

2554.B.40

#### Lamptype

⇒ T16FQ T5 G5 (4) 54W 230V

#### Dimensions

↔ L2660xB60xH92

### 2556.A/.. - CLIP DOUBLE

~230V



IP20



1,5 m



0,5 m



05.10.50



lighting system - PC 2 x 1200mm - with electronic gear  
Lichtsystem - PC 2 x 1200mm - mit elektronischem  
Vorschaltgerät

Ref

2556.A.40

#### Lamptype

⇒ T16FH T5 G5 (6) 28W 230V

#### Dimensions

↔ L2660xB60xH92



Clip, customised for your needs. A simple sketch is sufficient for a detailed proposal. Don't forget to mention the source: (T5 - MR16 - R7s etc...)

Clip, maßgeschneidert auf Ihre Wünsche. Eine einfache Skizze mit Angabe des Leuchtmittels (T5 - MR16 - R7s etc...) genügt für ein komplettes, detailliertes Angebot.

**2560.C/.. - CLIP DOUBLE**

~230V   IP20    1,5 m  0,5 m  



lighting system - PC 2 x 1500mm - with electronic gear  
Lichtsystem - PC 2 x 1500mm - mit elektronischem  
Vorschaltgerät

**Ref**

2560.C.40

**Lamp type**

⇒ T16FH T5 G5 (2) 35W 230V

**Dimensions**

↔ L3260xB60xH92

**2560.D/.. - CLIP DOUBLE**

~230V   IP20    1,5 m  0,5 m  



lighting system - PC 2 x 1500mm - with electronic gear  
Lichtsystem - PC 2 x 1500mm - mit elektronischem  
Vorschaltgerät

**Ref**

2560.D.40

**Lamp type**

⇒ T16FQ T5 G5 (2) 49W 230V

**Dimensions**

↔ L3260xB60xH92

**2562.C/.. - CLIP DOUBLE**

~230V   IP20    1,5 m  0,5 m  



lighting system - PC 2 x 1500mm - with electronic gear  
Lichtsystem - PC 2 x 1500mm - mit elektronischem  
Vorschaltgerät

**Ref**

2562.C.40

**Lamp type**

⇒ T16FH T5 G5 (4) 35W 230V

**Dimensions**

↔ L3260xB60xH92

**2562.D/.. - CLIP DOUBLE**

~230V   IP20    1,5 m  0,5 m  



lighting system - PC 2 x 1500mm - with electronic gear  
Lichtsystem - PC 2 x 1500mm - mit elektronischem  
Vorschaltgerät

**Ref**

2562.D.40

**Lamp type**

⇒ T16FQ T5 G5 (4) 49W 230V

**Dimensions**

↔ L3260xB60xH92

## INDOOR | Profiles | CLIP DOUBLE | CLIP WALL

Clip, customised for your needs. A simple sketch is sufficient for a detailed proposal. Don't forget to mention the source: (T5 - MR16 - R7s etc...)

Clip, maßgeschneidert auf Ihre Wünsche. Eine einfache Skizze mit Angabe des Leuchtmittels (T5 - MR16 - R7s etc...) genügt für ein komplettes, detailliertes Angebot.

### 2564.C/.. - CLIP DOUBLE

~230V



IP20



1,5 m



0,5 m



05.10.50



lighting system - PC 2 x 1500mm - with electronic gear  
Lichtsystem - PC 2 x 1500mm - mit elektronischem  
Vorschaltgerät

Ref

2564.C.40

#### Lamp type

⇒ T16FH T5 G5 (4) 35W

230V

#### Dimensions

↔ L3260xB60xH92

### 2564.D/.. - CLIP DOUBLE

~230V



IP20



1,5 m



0,5 m



05.10.50



lighting system - PC 2 x 1500mm - with electronic gear  
Lichtsystem - PC 2 x 1500mm - mit elektronischem  
Vorschaltgerät

Ref

2564.D.40

#### Lamp type

⇒ T16FQ T5 G5 (4) 49W

230V

#### Dimensions

↔ L3260xB60xH92

### 2566.C/.. - CLIP DOUBLE

~230V



IP20



1,5 m



14,6000



0,5 m



05.10.50



lighting system - PC 2 x 1500mm - with electronic gear  
Lichtsystem - PC 2 x 1500mm - mit elektronischem  
Vorschaltgerät

Ref

2566.C.40

#### Lamp type

⇒ T16FH T5 G5 (6) 35W

230V

#### Dimensions

↔ L3260xB60xH92

### 2567.SET/.. - CLIP WALL

~230V



IP20

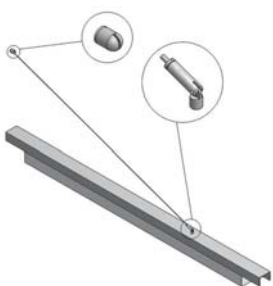

accessories for lighting systems - on request  
Zubehör für Lichtsysteme - auf Anfrage

Ref

2567.SET

#### Dimensions

↔ L1400xB60xH95

2595/.. - LINEA

~230V    IP20    1,5 m  0,5 m  

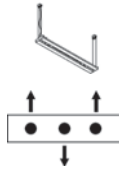

lighting system - current supply sidelong - with transformer - with electronic gear  
 Lichtsystem - laterale Stromzuführung - mit Trafo - mit elektronischem Vorschaltgerät

Ref  
 2595.40

Lamp type

- ⇒ T16FH T5 G5 (3) 21W 230V
- ◁ QR-CB 51 GU5,3/GX5,3 (2) 50W 12V

Dimensions

↔ L1600xB220xH50

2x60VA

2596/.. - LINEA

~230V    IP20    1,5 m  11,000  0,5 m  

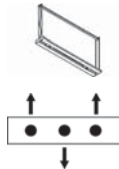

lighting system - current supply to choose - with transformer - with electronic gear  
 Lichtsystem - Stromzuführung auf Wahl - mit Trafo - mit elektronischem Vorschaltgerät

Ref  
 2596.40

Lamp type

- ⇒ T16FH T5 G5 (3) 21W 230V
- ◁ QR-CB 51 GU5,3/GX5,3 (2) 50W 12V

Dimensions

↔ L1600xB220xH50

2x60VA - standard with ceiling beam  
 standard mit Deckenbalken

2597/.. - LINEA

~230V    IP20    1,5 m  9,250  0,5 m  

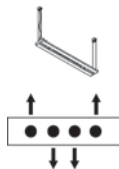

lighting system - current supply sidelong - with transformer - with electronic gear  
 Lichtsystem - laterale Stromzuführung - mit Trafo - mit elektronischem Vorschaltgerät

Ref  
 2597.40

Lamp type

- ⇒ T16FH T5 G5 (4) 21W 230V
- ◁ QR-CB 51 GU5,3/GX5,3 (2) 50W 12V

Dimensions

↔ L1600xB220xH50

2x60VA

2598/.. - LINEA

~230V    IP20    1,5 m  9,250  0,5 m  

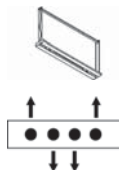

lighting system - current supply to choose - with transformer - with electronic gear  
 Lichtsystem - Stromzuführung auf Wahl - mit Trafo - mit elektronischem Vorschaltgerät

Ref  
 2598.40

Lamp type

- ⇒ T16FH T5 G5 (4) 21W 230V
- ◁ QR-CB 51 GU5,3/GX5,3 (2) 50W 12V

Dimensions

↔ L1600xB220xH50

2x60VA - standard with ceiling beam  
 standard mit Deckenbalken

Profiles indoor



2601/.. - MIKADO

~230V   IP20    1,5 m  2,0800  0,5 m  05.10.50 



lighting system - lamp not covered - with electronic gear  
Lichtsystem - Leuchtmittel nicht abgedeckt - mit elektronischem Vorschaltgerät

Ref  
2601.14

**Lamptype**

⇒ T16FQ T5 G5 (1) 24W 230V

**Dimensions**

↔ Ø35xL1004

without ceiling plate - with base 005  
ohne Deckenplatte - mit Rosette 005

2602/.. - MIKADO

~230V   IP20    1,5 m  3,7000  0,5 m  05.10.50 



lighting system - lamp not covered - with electronic gear  
Lichtsystem - Leuchtmittel nicht abgedeckt - mit elektronischem Vorschaltgerät

Ref  
2602.14

**Lamptype**

⇒ T16FQ T5 G5 (2) 24W 230V

**Dimensions**

↔ Ø35xL1764

without ceiling plate - with base 005 + 3 suspensions  
ohne Deckenplatte - mit Rosette 005 + 3 Abhängungen

2603/.. - MIKADO

~230V   IP20    1,5 m  4,5800  0,5 m  05.10.50 

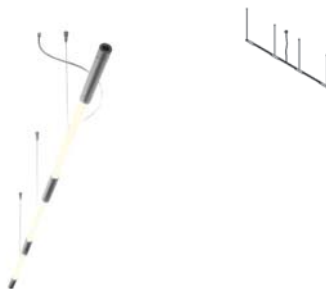

lighting system - lamp not covered - with electronic gear  
Lichtsystem - Leuchtmittel nicht abgedeckt - mit elektronischem Vorschaltgerät

Ref  
2603.14

**Lamptype**

⇒ T16FQ T5 G5 (3) 24W 230V

**Dimensions**

↔ Ø35xL2524

without ceiling plate - with base 005 + 4 suspensions  
ohne Deckenplatte - mit Rosette 005 + 4 Abhängungen

2604/.. - MIKADO WALL

~230V   IP20    0,8200  0,5 m  05.10.50 



build-up wall light - lamp not covered - with electronic gear  
Wandleuchte für Aufbau - Leuchtmittel nicht abgedeckt - mit elektronischem Vorschaltgerät

Ref  
2604.7

**Lamptype**

⇒ T16FQ T5 G5 (1) 24W 230V

**Dimensions**

↔ Ø35xL1004

2604.14

## INDOOR | Profiles | METRO

Metro, customised for your needs. A simple sketch is sufficient for a detailed proposal. Don't forget to mention the source: (TC-L - T5 - MR16 - R7s etc...)  
Metro, maßgeschneidert auf Ihre Wünsche. Eine einfache Skizze mit Angabe des Leuchtmittels (TC-L - T5 - MR16 - R7s etc...) genügt für ein komplettes, detailliertes Angebot.

### 2001/.. - METRO

IP20   1,9500 



accessories for lighting systems - per meter  
Zubehör für Lichtsysteme - pro Meter

#### Ref

2001.1  
2001.2  
2001.40

### 2005/.. - METRO

IP20   0,0300 



accessories for lighting systems - end plate  
Zubehör für Lichtsysteme - Endplatte

#### Ref

2005.1  
2005.2  
2005.40

### 2010/.. - METRO

IP20   0,1000 

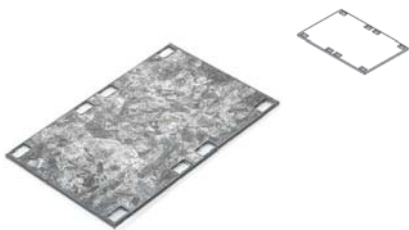

accessories for lighting systems - connecting module  
Zubehör für Lichtsysteme - Verbindungsmodul

#### Ref

2010

### 2006/.. - METRO

IP20   0,6833 



accessories for lighting systems  
Zubehör für Lichtsysteme

#### Ref

2006.1  
2006.2  
2006.40

Metro, customised for your needs. A simple sketch is sufficient for a detailed proposal. Don't forget to mention the source: (TC-L - T5 - MR16 - R7s etc...)  
 Metro, maßgeschneidert auf Ihre Wünsche. Eine einfache Skizze mit Angabe des Leuchtmittels (TC-L - T5 - MR16 - R7s etc...) genügt für ein komplettes, detailliertes Angebot.

2007/.. - METRO

IP20   0,6700 



accessories for lighting systems - angle 135°  
 Zubehör für Lichtsysteme - Eckverbindung 135°

Ref

- 2007.1
- 2007.2
- 2007.40

2008/.. - METRO

IP20   0,9600 



accessories for lighting systems - T-joint  
 Zubehör für Lichtsysteme - T-Verbindung

Ref

- 2008.1
- 2008.2
- 2008.40

2009/.. - METRO

IP20   1,2900 

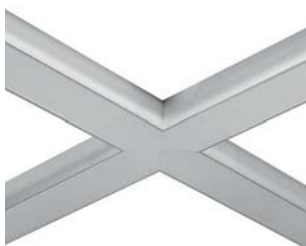

accessories for lighting systems - cruciform joint  
 Zubehör für Lichtsysteme - Kreuzstück

Ref

- 2009.1
- 2009.2
- 2009.40

2020/.. - METRO

IP20   0,0200 



accessories for lighting systems - ceiling base for steel wire  
 Zubehör für Lichtsysteme - Deckenbasis für Stahldraht

Dimensions

↔ Ø20xH30

Ref

- 2020.1
- 2020.2
- 2020.43

## INDOOR | Profiles | METRO | ROSETTE

Metro, customised for your needs. A simple sketch is sufficient for a detailed proposal. Don't forget to mention the source: (TC-L - T5 - MR16 - R7s etc...)  
Metro, maßgeschneidert auf Ihre Wünsche. Eine einfache Skizze mit Angabe des Leuchtmittels (TC-L - T5 - MR16 - R7s etc...) genügt für ein komplettes, detailliertes Angebot.

### 2021/.. - METRO

IP20   0,0800 



accessories for lighting systems - steel wire suspension + height controller M4  
Zubehör für Lichtsysteme - Stahldraht Abhängung + Höheregler M4

#### Ref

2021.1  
2021.2  
2021.43

### 2022/.. - METRO

IP20   0,0200 

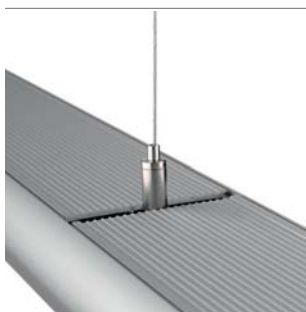

accessories for lighting systems - steel wire suspension + height controller M4  
Zubehör für Lichtsysteme - Stahldraht Abhängung + Höheregler M4

#### Ref

2022.1  
2022.2  
2022.43

### 2023/.. - METRO

IP20   0,1100 



accessories for lighting systems - steel wire suspension + height controller M8  
Zubehör für Lichtsysteme - Stahldraht Abhängung + Höheregler M8

#### Ref

2023

### 2024/.. - ROSETTE - M12

  IP20    0,0880 



build-up rosette - round - without transformer  
Aufbaurosette - rund - ohne Trafo

#### Dimensions

↔ Ø60xH68

#### Ref

2024.1  
2024.1M  
2024.2  
2024.10  
2024.11

build-up  
only for profiles  
nur für Profile



Metro, customised for your needs. A simple sketch is sufficient for a detailed proposal. Don't forget to mention the source: (TC-L - T5 - MR16 - R7s etc...)  
 Metro, maßgeschneidert auf Ihre Wünsche. Eine einfache Skizze mit Angabe des Leuchtmittels (TC-L - T5 - MR16 - R7s etc...) genügt für ein komplettes, detailliertes Angebot.

2025/.. - ROSETTE - M10



build-up rosette - round - without transformer  
 Aufbaurosette - rund - ohne Trafo

Dimensions

↔ Ø60xH40

Ref

- 2025.1
- 2025.1M
- 2025.2
- 2025.4
- 2025.7
- 2025.10
- 2025.11
- 2025.13
- 2025.14
- 2025.16
- 2025.23

build-up

2026/.. - METRO



accessories for lighting systems  
 Zubehör für Lichtsysteme

Dimensions

↔ L400

Ref

- 2026.1
- 2026.2
- 2026.11

40cm not stretched - standard cabling 1 circuit  
 40cm nicht ausgedehnt - standard Verkabelung 1 Stromkreis

2027/.. - METRO



accessories for lighting systems  
 Zubehör für Lichtsysteme

Options

SEXTRACIRCUIT/.. - CIRCUIT

Ref

- 2027.1
- 2027.2
- 2027.11

40cm not stretched - standard cabling 1 circuit  
 40cm nicht ausgedehnt - standard Verkabelung 1 Stromkreis

2029/.. - METRO



accessories for lighting systems - transparent cable per 2 meters - current supply 3x1  
 Zubehör für Lichtsysteme - transparentes Kabel pro 2 Meter - Stromzuführung 3x1

Ref

- 2029

## INDOOR | Profiles | METRO | CIRCUIT

Metro, customised for your needs. A simple sketch is sufficient for a detailed proposal. Don't forget to mention the source: (TC-L - T5 - MR16 - R7s etc...)  
Metro, maßgeschneidert auf Ihre Wünsche. Eine einfache Skizze mit Angabe des Leuchtmittels (TC-L - T5 - MR16 - R7s etc...) genügt für ein komplettes, detailliertes Angebot.

### 2031/.. - METRO

IP20



accessories for lighting systems - black cable per 2 meters -  
current supply 3x1  
Zubehör für Lichtsysteme - schwarzes Kabel pro 2 Meter -  
Stromzuführung 3x1

Ref

2031

### 202./.. - METRO

IP20



accessories for lighting systems - fixed rod Ø12 for directional  
profile  
Zubehör für Lichtsysteme - feste Stange Ø12 für  
schwenkbares Profil

#### Dimensions

↔ Ø12

Colour	2028/..	2030/..	2032/..	2035/..
	H 100	H 300	H 500	H 800
1				
2				
43				

### SEXTRACIRCUIT/.. - CIRCUIT

IP20



accessories for lighting systems - cabling extra circuit  
Zubehör für Lichtsysteme - Verkabelung zusätzlicher  
Stromkreis

Ref

SEXTRACIRCUIT

Metro, customised for your needs. A simple sketch is sufficient for a detailed proposal. Don't forget to mention the source: (TC-L - T5 - MR16 - R7s etc...)  
 Metro, maßgeschneidert auf Ihre Wünsche. Eine einfache Skizze mit Angabe des Leuchtmittels (TC-L - T5 - MR16 - R7s etc...) genügt für ein komplettes, detailliertes Angebot.

2033/.. - METRO

IP20  



for uplight  
für uplight

accessories for lighting systems - light gap on top per lamp  
 Zubehör für Lichtsysteme - Lichtöffnung an der Obenseite pro Leuchtmittel

Ref  
2033

T26/.. - METRO

~230V         



build-in module - for fluorescent lamp - with magnetic gear  
 Einbaumodul - für Leuchtstofflampe - mit magnetischem Vorschaltgerät

Reference	Length	Openings	Type of lamp
2050	900	5	T26 G13 (1) 18W / 230V
2051	1200	7	T26 G13 (1) 30W / 230V
2052	1500	9	T26 G13 (1) 36W / 230V
2053	1800	12	T26 G13 (1) 58W / 230V

T5 FQ-FH/.. - METRO

~230V         



build-in module - for fluorescent lamp - with electronic gear  
 Einbaumodul - für Leuchtstofflampe - mit elektronischem Vorschaltgerät

Reference	Length	Openings	Type of lamp
2140	1070	5	T16FQ T5 G5 (2) 24W / 230V
2141	1640	9	T16FH T5 G5 (2) 28W / 230V
2142	1890	12	T16FH T5 G5 (2) 35W / 230V
2143	1640	9	T16FQ T5 G5 (2) 54W / 230V

2070/.. - METRO

~230V         



accessories for lighting systems - recessed module for uplight  
 Zubehör für Lichtsysteme - Einbaumodul für Uplight

**Lamp type**  
 — QT-DE 12 114,1mm R7s (1) 300W 230V

**Dimensions**  
 ↔ L250

Ref  
2070

## INDOOR | Profiles | METRO

Metro, customised for your needs. A simple sketch is sufficient for a detailed proposal. Don't forget to mention the source: (TC-L - T5 - MR16 - R7s etc...)  
Metro, maßgeschneidert auf Ihre Wünsche. Eine einfache Skizze mit Angabe des Leuchtmittels (TC-L - T5 - MR16 - R7s etc...) genügt für ein komplettes, detailliertes Angebot.

### 2075/.. - METRO

~12V



standard with black ring  
standard mit schwarzem Ring

accessories for lighting systems - recessed module for halogen fixed spot - without transformer  
Zubehör für Lichtsysteme - Einbaumodul für festen Halogenspot - ohne Trafo

Ref

2075

#### Lamp type

QR-CB 51 GU5,3/GX5,3 (1) 50W 12V

#### Dimensions

L250

#### Options

2077/.. - METRO

2078/.. - METRO

### 2077/.. - METRO



accessories for lighting systems - electronic transformer 60VA + assembly  
Zubehör für Lichtsysteme - elektronischer Trafo 60VA + Montage

Ref

2077

### 2078/.. - METRO



accessories for lighting systems - electronic transformer 105VA + assembly  
Zubehör für Lichtsysteme - elektronischer Trafo 105VA + Montage

Ref

2078

### 2080/.. - METRO



accessories for lighting systems - assembly directional spotlight  
Zubehör für Lichtsysteme - Montage schwenkbaren Spot

Ref

2080

Metro, customised for your needs. A simple sketch is sufficient for a detailed proposal. Don't forget to mention the source: (TC-L - T5 - MR16 - R7s etc...)  
 Metro, maßgeschneidert auf Ihre Wünsche. Eine einfache Skizze mit Angabe des Leuchtmittels (TC-L - T5 - MR16 - R7s etc...) genügt für ein komplettes, detailliertes Angebot.

2079/.. - METRO

IP20   



accessories for lighting systems - assembly directional spotlight  
 Zubehör für Lichtsysteme - Montage schwenkbaren Spot

Ref  
 2079

spotlight not included  
 Strahler nicht einbegriffen

TC-L KVG/.. - METRO

~230V   IP20    0,5 m  05.10.50 



build-in module - for compact fluorescent lamp - with magnetic gear  
 Einbaumodul - für Kompaktleuchtstofflampe - mit magnetischem Vorschaltgerät

Reference	Length	Openings	Type of lamp
2054	500	2	TC-L 2G11 (1) 18W / 230V
2055	600	3	TC-L 2G11 (1) 24W / 230V
2056	700	3	TC-L 2G11 (1) 36W / 230V
2057	1000	4	TC-L 2G11 (2) 18W / 230V
2058	1200	5	TC-L 2G11 (2) 24W / 230V
2059	1400	5	TC-L 2G11 (2) 36W / 230V

TC-L EVG/.. - METRO

~230V   IP20    0,5 m  05.10.50 



build-in module - for compact fluorescent lamp - with electronic gear  
 Einbaumodul - für Kompaktleuchtstofflampe - mit elektronischem Vorschaltgerät

Reference	Length	Openings	Type of lamp
2060	570	2	TC-L 2G11 (1) 18W / 230V
2061	670	3	TC-L 2G11 (1) 24W / 230V
2062	770	3	TC-L 2G11 (1) 36W / 230V
2063	900	4	TC-L 2G11 (1) 55W / 230V
2064	1400	5	TC-L 2G11 (2) 36W / 230V
2065	1650	6	TC-L 2G11 (2) 55W / 230V



# METRO | AFMETINGEN T16 -T26

**T16 14W & 24W**

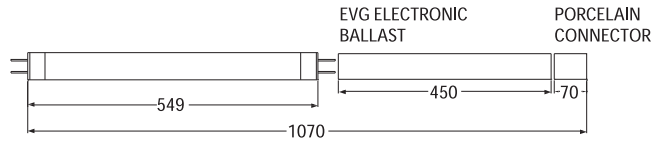

**T16 21W & 39W**

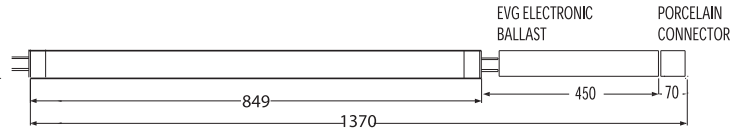

**T16 28W & 54W**

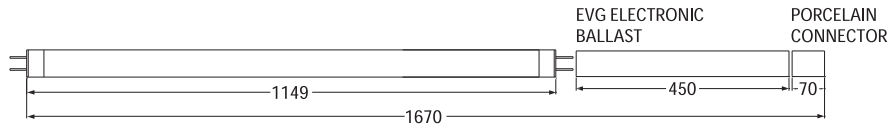

**T16 35W - 49W - 80W**

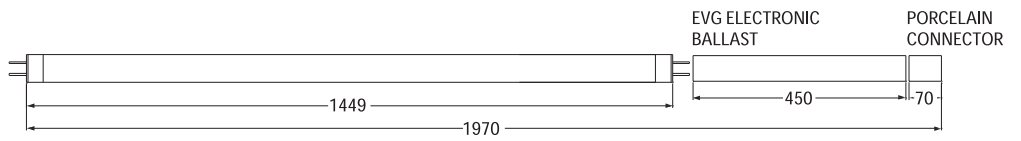

**T26 15W**

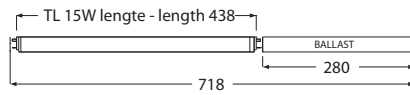

**T26 18W**

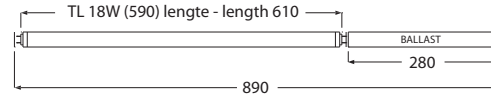

**T26 30W**

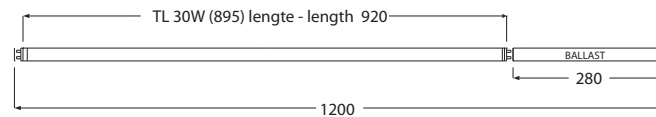

**T26 36W**

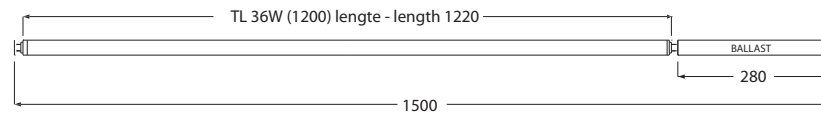

**T26 58W**

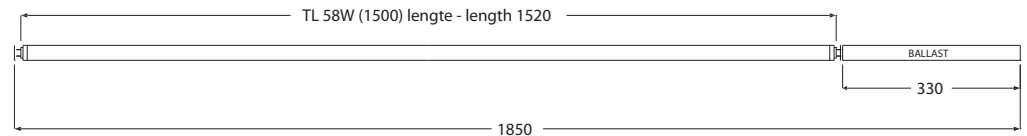

**MODULE DOWNLIGHT**

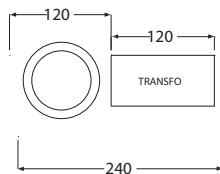

hoekverbinding 90°  
raccord angulaire 90°  
90° junction  
Eckverbinder  
art.2006/40

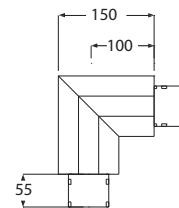

**MODULE SPOTLIGHT**

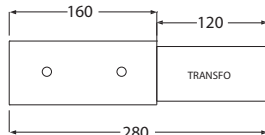

doorverbindingsmodule  
module de jonction  
connecting module  
Verbindungsmodul  
art.2010



METRO | AFMETINGEN TC-L

**TC-L 18W**

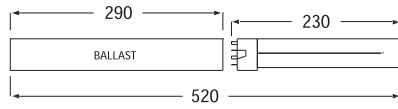

**TC-L 24W**

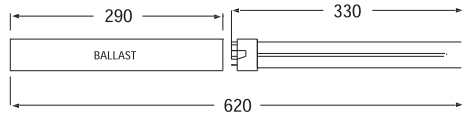

**TC-L 36W**

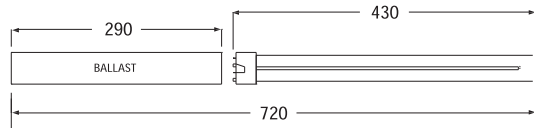

**TC-L 2x36W**

naast elkaar  
l'un à côté de l'autre  
joining - nebeneinander

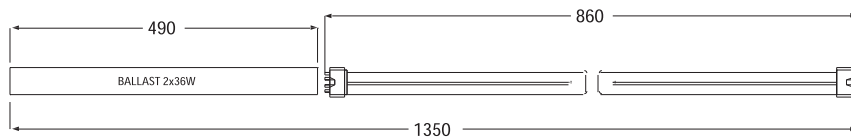

**TC-L 2x36W**

ballast in center  
ballast au milieu  
gear in the middle  
Vorschaltgerät im Mitten

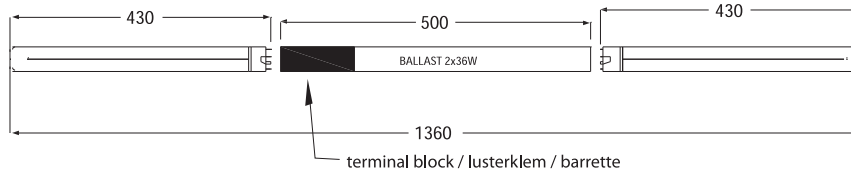

**TC-L 2x36W**

ballast in center  
ballast au milieu  
gear in the middle  
Vorschaltgerät im Mitten

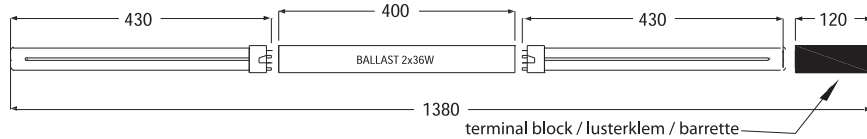

**TC-L 55W**

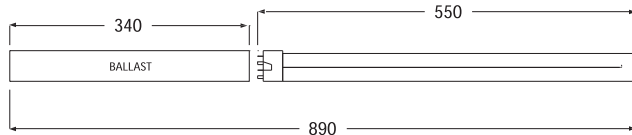

**TC-L 2x55W**

naast elkaar  
l'un à côté de l'autre  
joining - nebeneinander



**TC-L 2x55W**

ballast in center  
ballast au milieu  
gear in the middle  
Vorschaltgerät im Mitten

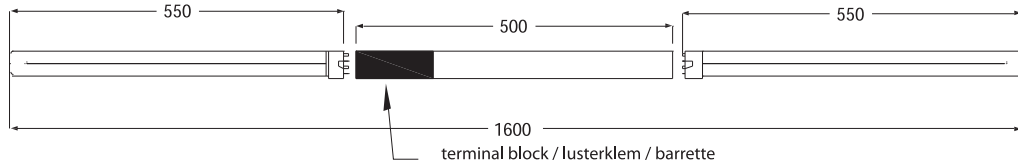

**TC-L 2x55W**

ballast in center  
ballast au milieu  
gear in the middle  
Vorschaltgerät im Mitten

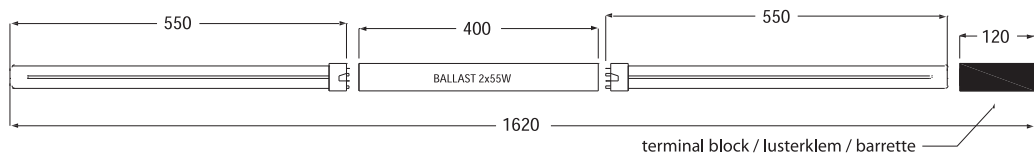

Profiles indoor

## INDOOR | Profiles

Metro, customised for your needs. A simple sketch is sufficient for a detailed proposal. Don't forget to mention the source: (TC-L - T5 - MR16 - R7s etc...)  
Metro, maßgeschneidert auf Ihre Wünsche. Eine einfache Skizze mit Angabe des Leuchtmittels (TC-L - T5 - MR16 - R7s etc...) genügt für ein komplettes, detailliertes Angebot.

### 2016/.. - METRO

IP20   0,2900 



accessories for lighting systems  
Zubehör für Lichtsysteme

#### Ref

2016.1  
2016.2  
2016.40

### 2017/.. - METRO

IP20   0,2900 



accessories for lighting systems - angle 135°  
Zubehör für Lichtsysteme - Eckverbindung 135°

#### Ref

2017.1  
2017.2  
2017.40

### 2018/.. - METRO

IP20   0,2900 



accessories for lighting systems  
Zubehör für Lichtsysteme

#### Ref

2018.1  
2018.2  
2018.40

### 2019/.. - METRO

IP20   0,2800 

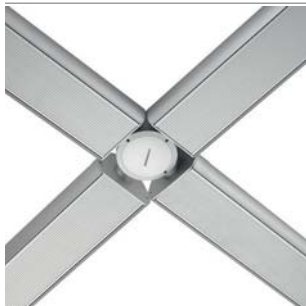

accessories for lighting systems - cross connector  
Zubehör für Lichtsysteme - Kreuzverbindung

#### Ref

2019.1  
2019.2  
2019.40



Metro, customised for your needs. A simple sketch is sufficient for a detailed proposal. Don't forget to mention the source: (TC-L - T5 - MR16 - R7s etc...)  
 Metro, maßgeschneidert auf Ihre Wünsche. Eine einfache Skizze mit Angabe des Leuchtmittels (TC-L - T5 - MR16 - R7s etc...) genügt für ein komplettes, detailliertes Angebot.

2011/.. - METRO

IP20   0,0400 



accessories for lighting systems - end plate with directional cover  
 Zubehör für Lichtsysteme - Endplatte mit richtbarer Abdeckung

**Ref**  
 2011.1  
 2011.2  
 2011.40

2012/.. - METRO

IP20   0,0400 



accessories for lighting systems - suspension cover M8  
 Zubehör für Lichtsysteme - Abhängung M8

**Ref**  
 2012.1  
 2012.2  
 2012.40

2013/.. - METRO

IP20   0,0400 



accessories for lighting systems - suspension cover M8 + current supply  
 Zubehör für Lichtsysteme - Abhängung M8 + Stromzuführung

**Ref**  
 2013.1  
 2013.2  
 2013.40

2014/.. - METRO

IP20   0,0500 



accessories for lighting systems - straight connector with M8  
 Zubehör für Lichtsysteme - waagerechter Verbinder mit M8

**Ref**  
 2014.1  
 2014.2  
 2014.40

## INDOOR | Profiles | METRO

Metro, customised for your needs. A simple sketch is sufficient for a detailed proposal. Don't forget to mention the source: (TC-L - T5 - MR16 - R7s etc...)  
Metro, maßgeschneidert auf Ihre Wünsche. Eine einfache Skizze mit Angabe des Leuchtmittels (TC-L - T5 - MR16 - R7s etc...) genügt für ein komplettes, detailliertes Angebot.

### 2015/.. - METRO

IP20   0,0400 



accessories for lighting systems - suspension with rod M12  
Zubehör für Lichtsysteme - Abhängung mit Stange M12

#### Ref

2015.1  
2015.2  
2015.40

### 2100A/.. - METRO

~230V  [KVG] IP20    1,5 m  4,6600  0,5 m  05.10.50 



lighting system - 5 openings - with magnetic gear  
Lichtsystem - 5 Löcher - mit magnetischem Vorschaltgerät

#### Ref

2100A.40

#### Lamp type

⇒ T26 G13 (1) 18W 230V

#### Dimensions

⇔ Ø100xL1100

### 2101A/.. - METRO

~230V  [KVG] IP20    1,5 m  5,1500  0,5 m  05.10.50 

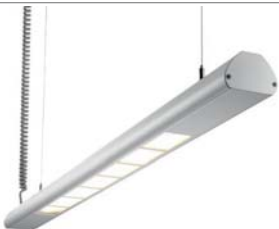

lighting system - 7 openings - with magnetic gear  
Lichtsystem - 7 Löcher - mit magnetischem Vorschaltgerät

#### Ref

2101A.40

#### Lamp type

⇒ T26 G13 (1) 30W 230V

#### Dimensions

⇔ Ø100xL1400

### 2102A/.. - METRO

~230V  [KVG] IP20    1,5 m  4,9800  0,5 m  05.10.50 

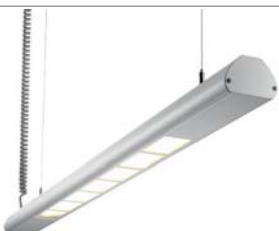

lighting system - 9 openings - with magnetic gear  
Lichtsystem - 9 Löcher - mit magnetischem Vorschaltgerät

#### Ref

2102A.40

#### Lamp type

⇒ T26 G13 (1) 36W 230V

#### Dimensions

⇔ Ø100xL1700

2103A/.. - METRO

~230V   IP20    1,5 m  5,8600  0,5 m  05.10.50 



lighting system - 12 openings - with magnetic gear  
Lichtsystem - 12 Löcher - mit magnetischem Vorschaltgerät

Ref  
2103A.40

**Lamptype**  
⇒ T26 G13 (1) 58W 230V

**Dimensions**  
↔ Ø100xL2100

2104A/.. - METRO

~230V   IP20    1,5 m  5,3200  0,5 m  05.10.50 



lighting system - 2 x 3 openings - with magnetic gear  
Lichtsystem - 2 x 3 Löcher - mit magnetischem Vorschaltgerät

Ref  
2104A.40

**Lamptype**  
— TC-L 2G11 (2) 36W 230V

**Dimensions**  
↔ Ø100xL1500

2105A/.. - METRO

~230V   IP20    1,5 m  5,7000  0,5 m  05.10.50 



lighting system - 2 x 4 openings - with electronic gear  
Lichtsystem - 2 x 4 Löcher - mit elektronischem Vorschaltgerät

Ref  
2105A.40

**Lamptype**  
— TC-L 2G11 (2) 55W 230V

**Dimensions**  
↔ Ø100xL1700

2106A/.. - METRO

~230V    IP20    1,5 m  6,1000  0,5 m  05.10.50 



lighting system - 3 openings - with transformer - with magnetic gear  
Lichtsystem - 3 Löcher - mit Trafo - mit magnetischem Vorschaltgerät

Ref  
2106A.40

**Lamptype**  
— TC-L 2G11 (1) 36W 230V  
◁ QR-CB 51 GU5,3/GX5,3 (4) 50W 12V

**Dimensions**  
↔ Ø100xL1400

2x105VA - 4 step spotlights included  
4 Strahler Step einbegriffen

2108A/.. - METRO



~230V   IP20    1,5 m  4,5000  0,5 m  05.10.02 



lighting system - uplight - with transformer  
Lichtsystem - uplight - mit Trafo

Ref  
2108A.40

Lamp type

 QR-CB 51 GU5,3/GX5,3 (4) 50W 12V  
 QT-DE 12 114,1mm R7s (1) 300W 230V

Dimensions

 Ø100xL1400

2x105VA - 4 Step spotlights included  
4 Strahler Step einbegriffen

2107A/.. - METRO

~230V   IP20    1,5 m  3,8000  0,5 m  05.10.02 



lighting system - 3 build-in spots included - with transformer  
Lichtsystem - 3 Einbastrahler einbegriffen - mit Trafo

Ref  
2107A.40

Lamp type

 QR-CB 51 GU5,3/GX5,3 (3) 50W 12V

Dimensions

 Ø100xL1000

60VA + 105VA

2125/.. - METRO

~230V   IP20     1,0500  0,5 m  05.10.50 



lighting system - 3 openings - with magnetic gear  
Lichtsystem - 3 Löcher - mit magnetischem Vorschaltgerät

Ref  
2125.1M  
2125.40

Lamp type

 TC-L 2G11 (1) 18W 230V

Dimensions

 Ø100xH600

2126/.. - METRO

~230V   IP20     1,1850  0,5 m  05.10.50 



lighting system - 3 openings - with magnetic gear  
Lichtsystem - 3 Löcher - mit magnetischem Vorschaltgerät

Ref  
2126.1M  
2126.40

Lamp type

 TC-L 2G11 (1) 24W 230V

Dimensions

 Ø100xH850

2720/.. - NEPTUNUS WALL

~230V   IP20    0.5 m  05.10.50 



build-up wall light - 2 circuits - with electronic gear - with LED driver  
Wandleuchte für Aufbau - 2 Stromkreise - mit elektronischem Vorschaltgerät - mit Driver LED

Ref

2720.1M  
2720.14

Lamp type

⇒ T16FQ T5 G5 (2) 24W 230V  
⚙️ powerled 700mA . (4) 3W 700mA

Dimensions

↔️ L1200xB100xH40  
⚙️ L1000xB35xH35

build-up  
without LED on request  
ohne LED auf Anfrage

2721/.. - NEPTUNUS WALL

~230V   IP20    4,0575 0.5 m  05.10.50 



build-up wall light - 2 circuits - with electronic gear - with LED driver  
Wandleuchte für Aufbau - 2 Stromkreise - mit elektronischem Vorschaltgerät - mit Driver LED

Ref

2721.1M  
2721.14

Lamp type







⇒ T16FH T5 G5 (2) 21W 230V  
⚙️ powerled 700mA . (4) 3W 700mA

Dimensions

↔️ L1500xB100xH40  
⚙️ L1000xB35xH35

build-up  
without LED on request  
ohne LED auf Anfrage

2724/.. - NEPTUNUS PLAFOND

~230V   IP20    0.5 m  05.10.50 



ceiling light - 2 circuits - with electronic gear - with LED driver  
Deckenleuchte - 2 Stromkreise - mit elektronischem Vorschaltgerät - mit Driver LED

Ref

2724.1M  
2724.14

Lamp type





⇒ T16FQ T5 G5 (2) 24W 230V  
⚙️ powerled 700mA . (4) 3W 700mA

Dimensions

↔️ L1200xB100xH40

without LED - other dimensions or other lamps on request  
ohne LED - andere Abmessungen oder andere Lampen auf Anfrage

2725/.. - NEPTUNUS PLAFOND

~230V   IP20    0.5 m  05.10.50 



ceiling light - 2 circuits - with electronic gear - with LED driver  
Deckenleuchte - 2 Stromkreise - mit elektronischem Vorschaltgerät - mit Driver LED

Ref

2725.1M  
2725.14

Lamp type

⇒ T16FH T5 G5 (2) 21W 230V  
⚙️ powerled 700mA . (4) 3W 700mA

Dimensions

↔️ L1500xB100xH40

without LED - other dimensions or other lamps on request  
ohne LED - andere Abmessungen oder andere Lampen auf Anfrage

2727/.. - NEPTUNUS PENDEL

~230V   IP20    1,5 m  0,5 m  



lighting system - 2 circuits - with electronic gear - with LED driver  
 Lichtsystem - 2 Stromkreise - mit elektronischem Vorschaltgerät - mit Driver LED

Ref  
 2727.1M  
 2727.14

Lamp type

⇒ T16FQ T5 G5 (2) 24W 230V  
 ⚙️ powerled 700mA . (4) 3W 700mA

Dimensions

↔️ L 1200xB100xH40

without LED - other dimensions or other lamps on request  
 ohne LED - andere Abmessungen oder andere Lampen auf Anfrage

2728/.. - NEPTUNUS PENDEL

~230V   IP20    1,5 m  0,5 m  



lighting system - 2 circuits - with electronic gear - with LED driver  
 Lichtsystem - 2 Stromkreise - mit elektronischem Vorschaltgerät - mit Driver LED

Ref  
 2728.1M  
 2728.14

Lamp type

⇒ T16FH T5 G5 (2) 21W 230V  
 ⚙️ powerled 700mA . (4) 3W 700mA

Dimensions

↔️ L 1500xB100xH40

without LED - other dimensions or other lamps on request  
 ohne LED - andere Abmessungen oder andere Lampen auf Anfrage

1530/.. - PALLADIO

~230V   IP20    1,5 m  0,5 m  



pendant - with electronic gear  
 Pendelleuchte - mit elektronischem Vorschaltgerät

Ref  
 1530.40

Lamp type

⇒ T16FH T5 G5 (4) 14W 230V

Dimensions

↔️ L 650xB580xH40

1531/.. - PALLADIO

~230V   IP20    1,5 m  0,5 m  



pendant - with electronic gear  
 Pendelleuchte - mit elektronischem Vorschaltgerät

Ref  
 1531.40

Lamp type

⇒ T16FH T5 G5 (4) 21W 230V

Dimensions

↔️ L 950xB580xH40

1532/.. - PALLADIO

~230V   IP20    1,5 m  0,5 m  05.10.50 



pendant - with electronic gear  
Pendelleuchte - mit elektronischem Vorschaltgerät

Ref  
1532.40

**Lamptype**  
⇒ T16FH T5 G5 (4) 28W 230V

**Dimensions**  
↔ L1250xB580xH40

1533/.. - PALLADIO

~230V   IP20    1,5 m  0,5 m  05.10.50 



pendant - with electronic gear  
Pendelleuchte - mit elektronischem Vorschaltgerät

Ref  
1533.40

**Lamptype**  
⇒ T16FH T5 G5 (4) 35W 230V

**Dimensions**  
↔ L1550xB580xH40

1560/.. - SLIDE

~230V    IP20    1,5 m  8,3000  1 m  05.10.50 



lighting system - with transformer - with electronic gear  
Lichtsystem - mit Trafo - mit elektronischem Vorschaltgerät

Ref  
1560.40

**Lamptype**  
⇒ QR-LP111 G53 (6) 50W 12V  
⇒ T16FQ T5 G5 (4) 39W 230V

**Dimensions**  
↔ L1800xB210

3x105VA

1561/.. - SLIDE

~230V   IP20    1,5 m  0,5 m  05.10.50 



lighting system - with electronic gear  
Lichtsystem - mit elektronischem Vorschaltgerät

Ref  
1561.40

**Lamptype**  
⇒ T16FQ T5 G5 (4) 39W 230V

**Dimensions**  
↔ L1800xB210

## INDOOR | Profiles | WING

On request, Wing can be supplied in different shapes and sizes.  
Wing ist auf Anfrage in verschiedenen Formen und Größen erhältlich.

### 1544/.. - WING

~230V



ceiling light - with electronic gear  
Deckenleuchte - mit elektronischem Vorschaltgerät

Ref

1544.1M

#### Lamptype

TC-DEL G24Q2 (1) 18W 230V

1544.14

#### Dimensions

L300xB300xH70

### 1545/.. - WING

~230V



ceiling light - with electronic gear  
Deckenleuchte - mit elektronischem Vorschaltgerät

Ref

1545.1M

#### Lamptype

TC-DEL G24Q2 (2) 18W 230V

1545.14

#### Dimensions

L300xB300xH70

### 1546/.. - WING

~230V



ceiling light - with electronic gear  
Deckenleuchte - mit elektronischem Vorschaltgerät

Ref

1546.1M

#### Lamptype

T16FH T5 G5 (4) 14W 230V

1546.14

#### Dimensions

L600xB600xH70

### 1547/.. - WING

~230V



ceiling light - with electronic gear  
Deckenleuchte - mit elektronischem Vorschaltgerät

Ref

1547.1M

#### Lamptype

T16FQ T5 G5 (2) 24W 230V

1547.14

#### Dimensions

L600xB300xH70



On request, Wing can be supplied in different shapes and sizes.  
Wing ist auf Anfrage in verschiedenen Formen und Größen erhältlich.

1548/.. - WING

~230V  IP20    6,8575  0,5 m  05.10.50 



ceiling light - with electronic gear  
Deckenleuchte - mit elektronischem Vorschaltgerät

Ref

1548.1M

Lamptype

1548.14

⇒ T16FQ T5 G5 (2) 54W

230V

Dimensions

↔ L1200xB300xH70

1550/.. - WING PENDANT

~230V  IP20    1,5 m  3,0750  0,5 m  05.10.50 



pendant - with electronic gear  
Pendelleuchte - mit elektronischem Vorschaltgerät

Ref

1550.1M

Lamptype

1550.14

⇒ T16FQ T5 G5 (2) 54W

230V

Dimensions

↔ L1200xB300xH110

1551/.. - WING PENDANT

~230V  IP20    1,5 m  0,5 m  05.10.50 



pendant - with electronic gear  
Pendelleuchte - mit elektronischem Vorschaltgerät

Ref

1551.1M

Lamptype

1551.14

⇒ T16FQ T5 G5 (2) 24W

230V

Dimensions

↔ L600xB110xH300

1552/.. - WING PENDANT

~230V  IP20    1,5 m  0,5 m  05.10.50 



pendant - with electronic gear  
Pendelleuchte - mit elektronischem Vorschaltgerät

Ref

1552.1M

Lamptype

1552.14

⇒ T16FQ T5 G5 (2) 54W

230V

Dimensions

↔ L1200xB110xH300

## INDOOR | Profiles | WING PENDANT | WING WALL

On request, Wing can be supplied in different shapes and sizes.  
Wing ist auf Anfrage in verschiedenen Formen und Größen erhältlich.

### 1553/.. - WING PENDANT

~230V



IP20



1,5 m

0,5 m



pendant - with electronic gear  
Pendelleuchte - mit elektronischem Vorschaltgerät

Ref

1553.1M

#### Lamptype

← TC-DEL G24Q2 (1) 18W 230V

1553.14

#### Dimensions

↔ L300xB110xH300

### 1554/.. - WING PENDANT

~230V



IP20



1,5 m

0,5 m



pendant - with electronic gear  
Pendelleuchte - mit elektronischem Vorschaltgerät

Ref

1554.1M

#### Lamptype

⇒ T16FQ T5 G5 (2) 24W 230V

1554.14

#### Dimensions

↔ L300xB110xH600

### 1549/.. - WING WALL

~230V



IP20



0,5 m



build-up wall light - with electronic gear  
Wandleuchte für Aufbau - mit elektronischem Vorschaltgerät

Ref

1549.1M

#### Lamptype

← TC-DEL G24Q2 (1) 18W 230V

1549.14

#### Dimensions

↔ B300xH300xD110

behuizing in alu anodisé + glas 5mm dik - housing anodised aluminium + glass 5mm thick - boîtier en alu anodisé + verre 5mm épais  
 Gehäuse in Aluminium anodisiert + Glas 5mm dick

**LAVA**

1100./.. P.489 1103./.. P.498



**ETNA**

1109./.. P.496 1112./.. P.505

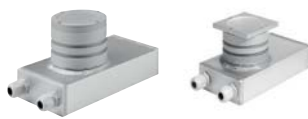

**COVER = WITH THE FLOOR**

2227.5./.. P.490 1164.A./.. P.500



2245.5./.. P.496 1147./.. P.505



**COVER ON THE FLOOR**

1120./.. P.493 1125.150./.. P.502



1155./.. P.497 1157./.. P.506



1100./..	489	1161.130.A./..	494
1102./..	489	1161.130.B./..	494
1103./..	498	1161.130.D./..	494
1105./..	498	1161.160.A./..	495
1109./..	496	1161.160.B./..	495
1112./..	505	1161.160.D./..	495
1117./..	500	1163.A./..	498
1119./..	500	1163.B./..	499
1120./..	493	1163.D./..	499
1122.130./..	493	1164.A./..	500
1122.160./..	494	1164.B./..	501
1123./..	502	1164.D./..	501
1125.130./..	502	1165.130.A./..	502
1125.150./..	502	1165.130.B./..	503
1147./..	505	1165.130.D./..	503
1155./..	497	1165.150.A./..	503
1157./..	506	1165.150.B./..	503
1160.A./..	490	1165.150.D./..	504
1160.B./..	490	2227.5./..	490
1160.D./..	490	2227.9./..	491



2229.5./..	491
2229.9./..	491
2245.5./..	496
2245.9./..	497
2306.5./..	489
2306.9./..	489
2307.5./..	499
2307.9./..	499
2309.5./..	491
2309.9./..	492
2310.24V.5./..	492
2310.24V.9./..	493
2310.230V.5./..	492
2310.230V.9./..	492
2311.5.130./..	495
2311.5.160./..	496
2313.5.130./..	504
2313.5.150./..	504
2317.5./..	501
2317.9./..	501

Grondspots (LAVA-ETNA) met **aluminium behuizing** zijn uitsluitend geschikt **voor binnen**.  
 Grondspots (LAVA-ETNA) met **inox behuizing** zijn zowel voor binnen als **voor buiten** geschikt.

Well lights (LAVA-ETNA) with **aluminium housing** are only suitable **for indoor use**.  
 Well lights (LAVA-ETNA) with **stainless steel housing** are suitable for indoor, as well as **outdoor use**.

Les spots de sol (LAVA-ETNA) avec **boîtier en aluminium** sont uniquement pour installation à **l'intérieur**.  
 Les spots de sol (LAVA-ETNA) avec **boîtier en inox** peuvent être installé à l'intérieur ainsi qu'à **l'extérieur**.

Bodeneinbauleuchten (LAVA-ETNA) mit **Aluminium Gehäuse** dürfen ausschließlich **im Haus** eingesetzt werden.  
 Bodeneinbauleuchten (LAVA-ETNA) mit **Edelstahl Gehäuse** dürfen sowohl Innen, als **Außen** eingesetzt werden.

**2320.230V/.. - TYPE A : LED CASSETTE 230V 3,6W IP65**

~230V  IP65    

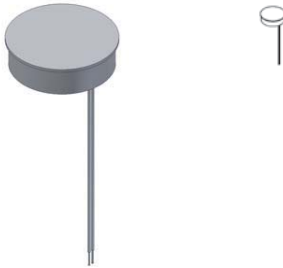

Niko-Erea LED - NW 4000K

accessories for garden lighting - fixed - not dimmable  
Zubehör für Gartenleuchten - fest - nicht dimmbar

Ref  
2320.230V.NW

**Lamptype**

 led 230V . (1) 3,6W 230V



**Dimensions**

↔ Ø70

**Options**

LAVA-ETNA LED  
TOLEDO FLOOR OR WALL

**2320.24V/.. - TYPE B : LED CASSETTE 24V-DC 3,6W IP65**

=24V-DC   IP65    



Niko-Erea LED - NW 4000K - parallel connection  
Parallelschaltung

accessories for garden lighting - fixed - not dimmable -  
without transformer  
Zubehör für Gartenleuchten - fest - nicht dimmbar - ohne  
Trafo

Ref  
2320.24V.NW

**Lamptype**

 led 24V-DC . (1) 3,6W 24V-DC

**Dimensions**

↔ Ø70

**Options**

LAVA-ETNA LED  
TOLEDO FLOOR OR WALL

**2321.230V/.. - TYPE C : LED CASSETTE 230V 4W IP65**

~230V  IP65    



Niko-Erea LED - NW4000K - other °angle reflector on  
demand  
andere °Winkel Reflektor auf Anfrage

accessories for floorlight - directional - not dimmable  
Zubehör für Bodenleuchte - schwenkbar - nicht dimmbar

Ref  
2321.230V.NW

**Lamptype**

 led 230V . (1) 4W 230V

**Dimensions**

↔ Ø70  $\wedge$  120° reflector

**2321.24V/.. - TYPE D : LED CASSETTE 24V-DC 4W IP65**

=24V-DC   IP65    



Niko-Erea LED - NW4000K - other °angle reflector on  
demand - parallel connection - PWM dimmable  
andere °Winkel Reflektor auf Anfrage -  
Parallelschaltung - PWM abblendbar

accessories for floorlight - directional - dimmable - without  
transformer  
Zubehör für Bodenleuchte - schwenkbar - abblendbar - ohne  
Trafo

Ref  
2321.24V.NW

**Lamptype**

 led 24V-DC . (1) 4W 24V-DC

**Dimensions**

↔ Ø70  $\wedge$  120° reflector



WO - op aanvraag wartelingang onderaan - sur demande presse-étoupe en bas - on request PG gland at the bottom - auf Anfrage PG Verschraubung unten

1100./.. - LAVA

~12V



floorlight - without transformer  
Bodenleuchte - ohne Trafo

Lamp type

QR-CB 51 GU5,3/GX5,3 (1) 50W 12V

Dimensions

Ø100xH104  
Ø102 √L 104  
5mm glass - Glas

Fixed	Directional
1100.ALU	1101.ALU
1100.INOX	1101.INOX
1100.MESS	1101.MESS

build-in

1102./.. - LAVA

~230V



floorlight - 230V  
Bodenleuchte - 230V

Lamp type

QPAR 51 GU10 (1) 35W 230V

Dimensions

Ø100xH104  
Ø102 √L 104  
5mm glass - Glas

Ref

1102.ALU  
1102.MESS  
1102.INOX

build-in

2306.5./.. - LAVA

~230V



floorlight - microlynx  
Bodenleuchte - microlynx

Lamp type

TC-FSE GX53 (1) 9W 230V

Dimensions

Ø100xH105  
Ø102 √L 110  
5mm glass - Glas

Ref

2306.5.ALU  
2306.5.MESS  
2306.5.INOX

build-in

2306.9./.. - LAVA

~230V



floorlight - microlynx  
Bodenleuchte - microlynx

Lamp type

TC-FSE GX53 (1) 9W 230V

Dimensions

Ø100xH105  
Ø102 √L 110  
9mm glass - Glas

Ref

2306.9.ALU  
2306.9.MESS  
2306.9.INOX

build-in

# INDOOR | Floorlights | LAVA | LAVA = even with the floor



WO - op aanvraag wartelingang onderaan - sur demande presse-étoupe en bas - on request PG gland at the bottom - auf Anfrage PG Verschraubung unten

## 1160.A/.. - LAVA

~230V



floorlight - LED 230V  
Bodenleuchte - LED 230V

### Lamptype

led 230V . (1) 3,6W

230V

### Dimensions

Ø100xH104

Ø102 √ 104

5mm glass - Glas

### Ref

1160.A.ALU

1160.A.MESS

1160.A.INOX

build-in

## 1160.B/.. - LAVA

=24V-DC



floorlight - without transformer  
Bodenleuchte - ohne Trafo

### Lamptype

led 24V-DC . (1) 3,6W

24V-DC

### Dimensions

Ø100xH104

Ø102 √ 104

5mm glass - Glas

### Ref

1160.B.ALU

1160.B.MESS

1160.B.INOX

build-in

parallel connection  
Parallelschaltung

## 1160.D/.. - LAVA

=24V-DC



floorlight - without transformer  
Bodenleuchte - ohne Trafo

### Lamptype

led 24V-DC . (1) 4W

24V-DC

Ø102 √ 104

5mm glass - Glas

### Ref

1160.D.ALU

1160.D.MESS

1160.D.INOX

build-in

parallel connection  
Parallelschaltung

## 2227.5/.. - LAVA = even with the floor

~12V



floorlight with build-in frame even with the floor - without transformer  
Bodenleuchte mit Einbaurahmen gleich mit dem Boden - ohne Trafo

### Lamptype

QR-CB 51 GU5,3/GX5,3 (1) 50W

12V

### Dimensions

Ø103xH135

Ø105 √ 140

5mm glass - Glas

build-in

Fixed	Directional
2227.5.ALU	2228.5.ALU
2227.5.INOX	2228.5.INOX
2227.5.MESS	2228.5.MESS



WO - op aanvraag wartelingang onderaan - sur demande presse-étoupe en bas - on request PG gland at the bottom - auf Anfrage PG Verschraubung unten

**2227.9/.. - LAVA = even with the floor**

~12V



floorlight with build-in frame even with the floor - without transformer  
Bodenleuchte mit Einbaurahmen gleich mit dem Boden - ohne Trafo

**Lamp type**

QR-CB 51 GU5,3/GX5,3 (1) 50W 12V

**Dimensions**

Ø103xH135  
Ø105 √L 140  
9mm glass - Glas

build-in

Fixed	Directional
2227.9.ALU	2228.9.ALU
2227.9.INOX	2228.9.INOX
2227.9.MESS	2228.9.MESS

**2229.5/.. - LAVA = even with the floor**

~230V



floorlight with build-in frame even with the floor - 230V  
Bodenleuchte mit Einbaurahmen gleich mit dem Boden - 230V

**Lamp type**

QPAR 51 GU10 (1) 35W 230V  
or QPAR 51 GU10 (1) 11W 230V

**Dimensions**

Ø103xH135  
Ø105 √L 140  
5mm glass - Glas

build-in

**Ref**

2229.5.ALU  
2229.5.MESS  
2229.5.INOX

**2229.9/.. - LAVA = even with the floor**

~230V



floorlight with build-in frame even with the floor - 230V  
Bodenleuchte mit Einbaurahmen gleich mit dem Boden - 230V

**Lamp type**

QPAR 51 GU10 (1) 35W 230V  
or QPAR 51 GU10 (1) 11W 230V

**Dimensions**

Ø103xH135  
Ø105 √L 140  
9mm glass - Glas

build-in

**Ref**

2229.9.ALU  
2229.9.MESS  
2229.9.INOX

**2309.5/.. - LAVA = even with the floor**

~230V



floorlight with build-in frame even with the floor - microlynx  
Bodenleuchte mit Einbaurahmen gleich mit dem Boden - microlynx

**Lamp type**

TC-FSE GX53 (1) 9W 230V

**Dimensions**

Ø103xH105  
Ø105 √L 110  
5mm glass - Glas

build-in

**Ref**

2309.5.ALU  
2309.5.MESS  
2309.5.INOX

## INDOOR | Floorlights | LAVA = even with the floor



WO - op aanvraag wartelingang onderaan - sur demande presse-étoupe en bas - on request PG gland at the bottom - auf Anfrage PG Verschraubung unten

### 2309.9/.. - LAVA = even with the floor

~230V



floorlight with build-in frame even with the floor - microlynx  
Bodenleuchte mit Einbaurahmen gleich mit dem Boden - microlynx

#### Lamptype

TC-FSE GX53 (1) 9W 230V

#### Dimensions

Ø103xH105  
Ø105 √L 110  
9mm glass - Glas

#### Ref

2309.9.ALU

2309.9.MESS

2309.9.INOX

build-in

### 2310.230V.5/.. - LAVA = even with the floor

~230V



floorlight with build-in frame even with the floor  
Bodenleuchte mit Einbaurahmen gleich mit dem Boden

#### Dimensions

Ø103xH135  
Ø105 √L 140  
5mm glass - Glas

A Fixed	C Directional
led 230V . (1) 3,6W / 230V	led 230V . (1) 4W / 230V
2310.A.5.ALU	2310.C.5.ALU
2310.A.5.INOX	2310.C.5.INOX
2310.A.5.MESS	2310.C.5.MESS

build-in

### 2310.230V.9/.. - LAVA = even with the floor

~230V



floorlight with build-in frame even with the floor  
Bodenleuchte mit Einbaurahmen gleich mit dem Boden

#### Dimensions

Ø103xH105  
Ø105 √L 140  
9mm glass - Glas

A Fixed	C Directional
led 230V . (1) 3,6W / 230V	led 230V . (1) 4W / 230V
2310.A.9.ALU	2310.C.9.ALU
2310.A.9.INOX	2310.C.9.INOX
2310.A.9.MESS	2310.C.9.MESS

build-in

### 2310.24V.5/.. - LAVA = even with the floor



floorlight with build-in frame even with the floor - without transformer  
Bodenleuchte mit Einbaurahmen gleich mit dem Boden - ohne Trafo

#### Dimensions

Ø103xH135  
Ø105 √L 140  
5mm glass - Glas

B Fixed	D Directional
led 24V-DC . (1) 3,6W / 24V-DC	led 24V-DC . (1) 4W / 24V-DC
2310.B.5.ALU	2310.D.5.ALU
2310.B.5.INOX	2310.D.5.INOX
2310.B.5.MESS	2310.D.5.MESS

build-in  
parallel connection  
Parallelschaltung



# INDOOR | Floorlights | LAVA = even with the floor | LAVA



WO - op aanvraag wartelingang onderaan - sur demande presse-étoupe en bas - on request PG gland at the bottom - auf Anfrage PG Verschraubung unten

## 2310.24V.9/.. - LAVA = even with the floor



floorlight with build-in frame even with the floor - without transformer  
Bodenleuchte mit Einbaurahmen gleich mit dem Boden - ohne Trafo

### Dimensions

- Ø103xH135
- 📏 Ø105 √L 140
- 🔍 5mm glass - Glas

B Fixed	D Directional
led 24V-DC . (1) 3,6W / 24V-DC	led 24V-DC . (1) 4W / 24V-DC
2310.B.9.ALU	2310.D.9.ALU
2310.B.9.INOX	2310.D.9.INOX
2310.B.9.MESS	2310.D.9.MESS

build-in  
parallel connection  
Parallelschaltung

## 1120/.. - LAVA



floorlight with cover plate on the floor - without transformer  
Bodenleuchte mit Abdeckplatte auf dem Boden - ohne Trafo

### Lamp type

🔊 QR-CB 51 GU5,3/GX5,3 (1) 50W 12V

### Dimensions

- Ø130-160xH104
- 📏 Ø102 √L 104
- 🔍 5mm glass - Glas

Fixed	Directional
1120.130.INOX	1121.130.INOX
1120.130.MESS	1121.130.MESS
1120.160.INOX	1121.160.INOX
1120.160.MESS	1121.160.MESS

build-in

## 1122.130/.. - LAVA



floorlight with cover plate on the floor - 230V  
Bodenleuchte mit Abdeckplatte auf dem Boden - 230V

### Lamp type

🔊 QPAR 51 GU10 (1) 35W 230V

### Dimensions

- Ø130xH104
- 📏 Ø102 √L 104
- 🔍 5mm glass - Glas

### Ref

1122.130.MESS  
1122.130.INOX

build-in

# INDOOR | Floorlights | LAVA



WO - op aanvraag wartelingang onderaan - sur demande presse-étoupe en bas - on request PG gland at the bottom - auf Anfrage PG Verschraubung unten

## 1122.160/.. - LAVA

~230V



floorlight with cover plate on the floor - 230V  
Bodenleuchte mit Abdeckplatte auf dem Boden - 230V

### Lamp type

QPAR 51 GU10 (1) 35W 230V

### Dimensions

Ø160xH104  
Ø102 H 104  
5mm glass - Glas

### Ref

1122.160.MESS  
1122.160.INOX

build-in

## 1161.130.A/.. - LAVA

~230V



floorlight with cover plate on the floor - fixed - LED 230V  
Bodenleuchte mit Abdeckplatte auf dem Boden - fest - LED 230V

### Lamp type

led 230V . (1) 3,6W 230V

### Dimensions

Ø130xH104  
Ø102 H 104  
5mm glass - Glas

### Ref

1161.130.A.MESS  
1161.130.A.INOX

build-in

## 1161.130.B/.. - LAVA

=24V-DC



floorlight with cover plate on the floor - fixed - without transformer  
Bodenleuchte mit Abdeckplatte auf dem Boden - fest - ohne Trafo

### Lamp type

led 24V-DC . (1) 3,6W 24V-DC

### Dimensions

Ø130xH104  
Ø102 H 104  
5mm glass - Glas

### Ref

1161.130.B.MESS  
1161.130.B.INOX

build-in

parallel connection  
Parallelschaltung

## 1161.130.D/.. - LAVA

=24V-DC



floorlight with cover plate on the floor - directional - without transformer  
Bodenleuchte mit Abdeckplatte auf dem Boden - schwenkbar - ohne Trafo

### Lamp type

led 24V-DC . (1) 4W 24V-DC

### Dimensions

Ø130xH104  
Ø102 H 104  
5mm glass - Glas

### Ref

1161.130.D.MESS  
1161.130.D.INOX

build-in

parallel connection  
Parallelschaltung

# INDOOR | Floorlights | LAVA | LAVA cover on the floor



WO - op aanvraag wartelingang onderaan - sur demande presse-étoupe en bas - on request PG gland at the bottom - auf Anfrage PG Verschraubung unten

## 1161.160.A/.. - LAVA

~230V



floorlight with cover plate on the floor - fixed - LED 230V  
Bodenleuchte mit Abdeckplatte auf dem Boden - fest - LED 230V

### Ref

1161.160.A.MESS  
1161.160.A.INOX

### Lamptype

led 230V . (1) 3,6W 230V

### Dimensions

Ø160xH104  
Ø102 √L 104  
5mm glass - Glas

build-in

## 1161.160.B/.. - LAVA

=24V-DC



floorlight with cover plate on the floor - fixed - without transformer  
Bodenleuchte mit Abdeckplatte auf dem Boden - fest - ohne Trafo

### Ref

1161.160.B.MESS  
1161.160.B.INOX

### Lamptype

led 24V-DC . (1) 3,6W 24V-DC

### Dimensions

Ø160xH104  
Ø102 √L 104  
5mm glass - Glas

build-in  
parallel connection  
Parallelschaltung

## 1161.160.D/.. - LAVA

=24V-DC



floorlight with cover plate on the floor - directional - without transformer  
Bodenleuchte mit Abdeckplatte auf dem Boden - schwenkbar - ohne Trafo

### Ref

1161.160.D.MESS  
1161.160.D.INOX

### Lamptype

led 24V-DC . (1) 4W 24V-DC

### Dimensions

Ø160xH104  
Ø102 √L 104  
5mm glass - Glas

build-in  
parallel connection  
Parallelschaltung

## 2311.5.130/.. - LAVA cover on the floor

~230V



floorlight with cover plate on the floor - microlynx  
Bodenleuchte mit Abdeckplatte auf dem Boden - microlynx

### Ref

2311.5.130.MESS  
2311.5.130.INOX

### Lamptype

TC-FSE GX53 (1) 9W 230V

### Dimensions

Ø130xH105  
Ø102 √L 110  
5mm glass - Glas

build-in

# INDOOR | Floorlights | LAVA cover on the floor | ETNA | ETNA = EVEN WITH THE FLOOR



WO - op aanvraag wartelingang onderaan - sur demande presse-étoupe en bas - on request PG gland at the bottom - auf Anfrage PG Verschraubung unten

## 2311.5.160/.. - LAVA cover on the floor

~230V



floorlight with cover plate on the floor - microlynx  
Bodenleuchte mit Abdeckplatte auf dem Boden - microlynx

### Lamptype

TC-FSE GX53 (1) 9W 230V

### Dimensions

Ø160xH105  
Ø102 H 110  
5mm glass - Glas

### Ref

2311.5.160.MESS

2311.5.160.INOX

build-in

## 1109./.. - ETNA

~230V



floorlight - with transformer  
Bodenleuchte - mit Trafo

### Lamptype

QR-CB 51 GU5,3/GX5,3 (1) 50W 12V

### Dimensions

L240xB125xH135  
H 135  
5mm glass - Glas

Fixed	Directional
1109.ALU	1110.ALU
1109.INOX	1110.INOX
1109.MESS	1110.MESS

build-in

## 2245.5./.. - ETNA = EVEN WITH THE FLOOR

~230V



floorlight with build-in frame even with the floor - with transformer  
Bodenleuchte mit Einbaurahmen gleich mit dem Boden - mit Trafo

### Lamptype

QR-CB 51 GU5,3/GX5,3 (1) 50W 12V

### Dimensions

L240xB125xH135  
H 140  
5mm glass - Glas

Fixed	Directional
2245.5.ALU	2246.5.ALU
2245.5.INOX	2246.5.INOX
2245.5.MESS	2246.5.MESS

build-in



WO - op aanvraag wartelingang onderaan - sur demande presse-étoupe en bas - on request PG gland at the bottom - auf Anfrage PG Verschraubung unten

2245.9/.. - ETNA = EVEN WITH THE FLOOR

~230V



floorlight with build-in frame even with the floor - with transformer  
Bodenleuchte mit Einbaurahmen gleich mit dem Boden - mit Trafo

Lamp type

QR-CB 51 GU5,3/GX5,3 (1) 50W 12V

Dimensions

L240xB125xH135

140

9mm glass - Glas

build-in

Fixed	Directional
2245.9.ALU	2246.9.ALU
2245.9.INOX	2246.9.INOX
2245.9.MESS	2246.9.MESS

1155/.. - ETNA

~230V



floorlight with cover plate on the floor - with transformer  
Bodenleuchte mit Abdeckplatte auf dem Boden - mit Trafo

Lamp type

QR-CB 51 GU5,3/GX5,3 (1) 50W 12V

Dimensions

L240xB125xH135

135

5mm glass - Glas

build-in

Fixed	Directional
1155.130.INOX	1156.130.INOX
1155.130.MESS	1156.130.MESS
1155.160.INOX	1156.160.INOX
1155.160.MESS	1156.160.MESS



# INDOOR | Floorlights | LAVA



WO - op aanvraag wartelingang onderaan - sur demande presse-étoupe en bas - on request PG gland at the bottom - auf Anfrage PG Verschraubung unten

## 1103./.. - LAVA

~12V



floorlight - without transformer  
Bodenleuchte - ohne Trafo

### Lamptype

QR-CB 51 GU5,3/GX5,3 (1) 50W 12V

### Dimensions

L100xB100xH104

102x102 104

5mm glass - Glas

### Options

S1139.5/.. - SUPPLEMENT SQUARE GLASS

build-in

Fixed	Directional
1103.ALU	1104.ALU
1103.INOX	1104.INOX
1103.MESS	1104.MESS

## 1105./.. - LAVA

~230V



floorlight - 230V  
Bodenleuchte - 230V

### Lamptype

QPAR 51 GU10 (1) 35W 230V

### Dimensions

L100xB100xH104

102x102 104

5mm glass - Glas

### Options

S1139.5/.. - SUPPLEMENT SQUARE GLASS

build-in

### Ref

1105.ALU  
1105.MESS  
1105.INOX

## 1163.A./.. - LAVA

~230V



floorlight - fixed - LED 230V  
Bodenleuchte - fest - LED 230V

### Lamptype

led 230V .(1) 3,6W 230V

### Dimensions

L100xB100xH104

102x102 104

5mm glass - Glas

### Options

S1139.5/.. - SUPPLEMENT SQUARE GLASS

build-in

### Ref

1163.A.ALU  
1163.A.MESS  
1163.A.INOX

# INDOOR | Floorlights | LAVA



WO - op aanvraag wartelingang onderaan - sur demande presse-étoupe en bas - on request PG gland at the bottom - auf Anfrage PG Verschraubung unten

## 1163.B/.. - LAVA

=24V-DC



floorlight - fixed - without transformer  
Bodenleuchte - fest - ohne Trafo

### Lamptype

led 24V-DC . (1) 3,6W 24V-DC

### Dimensions

L100xB100xH104

102x102 104

5mm glass - Glas

### Options

■ S1139.5/.. - SUPPLEMENT SQUARE GLASS

### Ref

1163.B.ALU

1163.B.MESS

1163.B.INOX

build-in  
parallel connection  
Parallelschaltung

## 1163.D/.. - LAVA

=24V-DC



floorlight - directional - without transformer  
Bodenleuchte - schwenkbar - ohne Trafo

### Lamptype

led 24V-DC . (1) 4W 24V-DC

### Dimensions

L100xB100xH104

102x102 104

5mm glass - Glas

### Options

■ S1139.5/.. - SUPPLEMENT SQUARE GLASS

### Ref

1163.D.ALU

1163.D.MESS

1163.D.INOX

build-in  
parallel connection  
Parallelschaltung

## 2307.5/.. - LAVA

~230V



floorlight - microlynx  
Bodenleuchte - microlynx

### Lamptype

TC-FSE GX53 (1) 9W 230V

### Dimensions

L100xB100xH105

102x102 110

5mm glass - Glas

### Options

■ S1139.5/.. - SUPPLEMENT SQUARE GLASS

### Ref

2307.5.ALU

2307.5.MESS

2307.5.INOX

build-in

## 2307.9/.. - LAVA

~230V



floorlight - microlynx  
Bodenleuchte - microlynx

### Lamptype

TC-FSE GX53 (1) 9W 230V

### Dimensions

L100xB100xH105

102x102 110

9mm glass - Glas

### Options

■ S1139.9/.. - SUPPLEMENT SQUARE GLASS

### Ref

2307.9.ALU

2307.9.MESS

2307.9.INOX

build-in

# INDOOR | Floorlights | LAVA



WO - op aanvraag wartelingang onderaan - sur demande presse-étoupe en bas - on request PG gland at the bottom - auf Anfrage PG Verschraubung unten

## 1117./.. - LAVA

~12V



build-in



floorlight with build-in frame even with the floor - without transformer  
Bodenleuchte mit Einbaurahmen gleich mit dem Boden - ohne Trafo

### Lamp type

QR-CB 51 GU5,3/GX5,3 (1) 50W 12V

### Dimensions

L104xB104xH104  
104x104 104  
5mm glass - Glas

### Options

S1139.5/.. - SUPPLEMENT SQUARE GLASS

Fixed	Directional
1117.ALU	1118.ALU
1117.INOX	1118.INOX
1117.MESS	1118.MESS

## 1119./.. - LAVA

~230V



build-in



floorlight with build-in frame even with the floor - 230V  
Bodenleuchte mit Einbaurahmen gleich mit dem Boden - 230V

### Lamp type

QPAR 51 GU10 (1) 35W 230V

### Dimensions

L104xB104xH104  
104x104 104  
5mm glass - Glas

### Options

S1139.5/.. - SUPPLEMENT SQUARE GLASS

### Ref

1119.ALU  
1119.MESS  
1119.INOX

## 1164.A./.. - LAVA

~230V



build-in



floorlight with build-in frame even with the floor - fixed - LED 230V  
Bodenleuchte mit Einbaurahmen gleich mit dem Boden - fest - LED 230V

### Lamp type

led 230V . (1) 3,6W 230V

### Dimensions

L104xB104xH104  
104x104 104  
5mm glass - Glas

### Options

S1139.5/.. - SUPPLEMENT SQUARE GLASS

### Ref

1164.A.ALU  
1164.A.MESS  
1164.A.INOX



# INDOOR | Floorlights | LAVA | LAVA = even with the floor



WO - op aanvraag wartelingang onderaan - sur demande presse-étoupe en bas - on request PG gland at the bottom - auf Anfrage PG Verschraubung unten

## 1164.B/.. - LAVA

=24V-DC



IP66



0,5183



0,5 m



floorlight with build-in frame even with the floor - fixed - without transformer  
Bodenleuchte mit Einbaurahmen gleich mit dem Boden - fest - ohne Trafo

### Lamptype

led 24V-DC . (1) 3,6W 24V-DC

### Dimensions

L104xB104xH104

104x104 104

5mm glass - Glas

### Options

■ S1139.5/.. - SUPPLEMENT SQUARE GLASS

### Ref

1164.B.ALU

1164.B.MESS

1164.B.INOX

build-in  
parallel connection  
Parallelschaltung

## 1164.D/.. - LAVA

=24V-DC



IP66



0,5500



0,5 m



floorlight with build-in frame even with the floor - directional - without transformer  
Bodenleuchte mit Einbaurahmen gleich mit dem Boden - schwenkbar - ohne Trafo

### Lamptype

led 24V-DC . (1) 4W 24V-DC

### Dimensions

L104xB104xH104

104x104 104

5mm glass - Glas

### Options

■ S1139.5/.. - SUPPLEMENT SQUARE GLASS

### Ref

1164.D.ALU

1164.D.MESS

1164.D.INOX

build-in  
parallel connection  
Parallelschaltung

## 2317.5/.. - LAVA = even with the floor

~230V



IP66



1,6600



0,5 m



floorlight with build-in frame even with the floor - microlynx  
Bodenleuchte mit Einbaurahmen gleich mit dem Boden - microlynx

### Lamptype

TC-FSE GX53 (1) 9W 230V

### Dimensions

L104xB104xH105

105x105 110

5mm glass - Glas

### Options

■ S1139.5/.. - SUPPLEMENT SQUARE GLASS

### Ref

2317.5.ALU

2317.5.MESS

2317.5.INOX

build-in

## 2317.9/.. - LAVA = even with the floor

~230V



IP66



1,8700



0,5 m



floorlight with build-in frame even with the floor - microlynx  
Bodenleuchte mit Einbaurahmen gleich mit dem Boden - microlynx

### Lamptype

TC-FSE GX53 (1) 9W 230V

### Dimensions

L104xB104xH105

105x105 110

9mm glass - Glas

### Options

■ S1139.9/.. - SUPPLEMENT SQUARE GLASS

### Ref

2317.9.ALU

2317.9.MESS

2317.9.INOX

build-in

# INDOOR | Floorlights | LAVA



WO - op aanvraag wartelingang onderaan - sur demande presse-étoupe en bas - on request PG gland at the bottom - auf Anfrage PG Verschraubung unten

## 1123../.. - LAVA

~12V



floorlight with cover plate on the floor - without transformer  
Bodenleuchte mit Abdeckplatte auf dem Boden - ohne Trafo

### Lamptype

QR-CB 51 GU5,3/GX5,3 (1) 50W 12V

### Dimensions

L 130-L150xB130-B150xH104

Ø102 H 104

5mm glass - Glas

Fixed	Directional
1123.130.INOX	1124.130.INOX
1123.130.MESS	1124.130.MESS
1123.150.INOX	1124.150.INOX
1123.150.MESS	1124.150.MESS

build-in

## 1125.130../.. - LAVA

~230V



floorlight with cover plate on the floor - 230V  
Bodenleuchte mit Abdeckplatte auf dem Boden - 230V

### Lamptype

QPAR 51 GU10 (1) 35W 230V

### Dimensions

L 130xB130xH104

Ø102 H 104

5mm glass - Glas

### Ref

1125.130.MESS

1125.130.INOX

build-in

## 1125.150../.. - LAVA

~230V



floorlight with cover plate on the floor - 230V  
Bodenleuchte mit Abdeckplatte auf dem Boden - 230V

### Lamptype

QPAR 51 GU10 (1) 35W 230V

### Dimensions

L 150xB150xH104

Ø102 H 104

5mm glass - Glas

### Ref

1125.150.MESS

1125.150.INOX

build-in

## 1165.130.A../.. - LAVA

~230V



floorlight with cover plate on the floor - fixed - LED 230V  
Bodenleuchte mit Abdeckplatte auf dem Boden - fest - LED 230V

### Lamptype

led 230V . (1) 3,6W 230V

### Dimensions

L 130xB130xH104

Ø102 H 104

5mm glass - Glas

### Ref

1165.130.A.MESS

1165.130.A.INOX

build-in



WO - op aanvraag wartelingang onderaan - sur demande presse-étoupe en bas - on request PG gland at the bottom - auf Anfrage PG Verschraubung unten

1165.130.B/.. - LAVA

=24V-DC III IP66 0,6625 0,5 m 05.10.02 CE



floorlight with cover plate on the floor - fixed - without transformer  
Bodenleuchte mit Abdeckplatte auf dem Boden - fest - ohne Trafo

Ref  
1165.130.B.MESS  
1165.130.B.INOX

Lamptype

led 24V-DC . (1) 3,6W 24V-DC

Dimensions

L130xB130xH104  
Ø102 104  
5mm glass - Glas

build-in  
parallel connection  
Parallelschaltung

1165.130.D/.. - LAVA

=24V-DC III IP66 0,6625 0,5 m 05.10.02 CE



floorlight with cover plate on the floor - directional - without transformer  
Bodenleuchte mit Abdeckplatte auf dem Boden - schwenkbar - ohne Trafo

Ref  
1165.130.D.MESS  
1165.130.D.INOX

Lamptype

led 24V-DC . (1) 4W 24V-DC

Dimensions

L130xB130xH104  
Ø102 104  
5mm glass - Glas

build-in  
parallel connection  
Parallelschaltung

1165.150.A/.. - LAVA

~230V IP66 0,6625 0,5 m 05.10.02 CE



floorlight with cover plate on the floor - fixed - LED 230V  
Bodenleuchte mit Abdeckplatte auf dem Boden - fest - LED 230V

Ref  
1165.150.A.MESS  
1165.150.A.INOX

Lamptype

led 230V . (1) 3,6W 230V

Dimensions

L150xB150xH104  
Ø102 104  
5mm glass - Glas

build-in

1165.150.B/.. - LAVA

=24V-DC III IP66 0,6625 0,5 m 05.10.02 CE



floorlight with cover plate on the floor - fixed - without transformer  
Bodenleuchte mit Abdeckplatte auf dem Boden - fest - ohne Trafo

Ref  
1165.150.B.MESS  
1165.150.B.INOX

Lamptype

led 24V-DC . (1) 3,6W 24V-DC

Dimensions

L150xB150xH104  
Ø102 104  
5mm glass - Glas

build-in  
parallel connection  
Parallelschaltung

## INDOOR | Floorlights | LAVA | LAVA cover on the floor



WO - op aanvraag wartelingang onderaan - sur demande presse-étoupe en bas - on request PG gland at the bottom - auf Anfrage PG Verschraubung unten

### 1165.150.D/.. - LAVA

=24V-DC



floorlight with cover plate on the floor - directional - without transformer  
Bodenleuchte mit Abdeckplatte auf dem Boden - schwenkbar - ohne Trafo

#### Ref

1165.150.D.MESS

1165.150.D.INOX

#### Lamptype

led 24V-DC . (1) 4W

24V-DC

#### Dimensions

L150xB150xH104

Ø102 104

5mm glass - Glas

build-in  
parallel connection  
Parallelschaltung

### 2313.5.130/.. - LAVA cover on the floor

~230V



floorlight with cover plate on the floor - microlynx  
Bodenleuchte mit Abdeckplatte auf dem Boden - microlynx

#### Ref

2313.5.130.MESS

2313.5.130.INOX

#### Lamptype

TC-FSE GX53 (1) 9W

230V

#### Dimensions

L130xB130xH105

Ø102 110

5mm glass - Glas

build-in

### 2313.5.150/.. - LAVA cover on the floor

~230V



floorlight with cover plate on the floor - microlynx  
Bodenleuchte mit Abdeckplatte auf dem Boden - microlynx

#### Ref

2313.5.150.MESS

2313.5.150.INOX

#### Lamptype

TC-FSE GX53 (1) 9W

230V

#### Dimensions

L150xB150xH105

Ø102 110

5mm glass - Glas

build-in

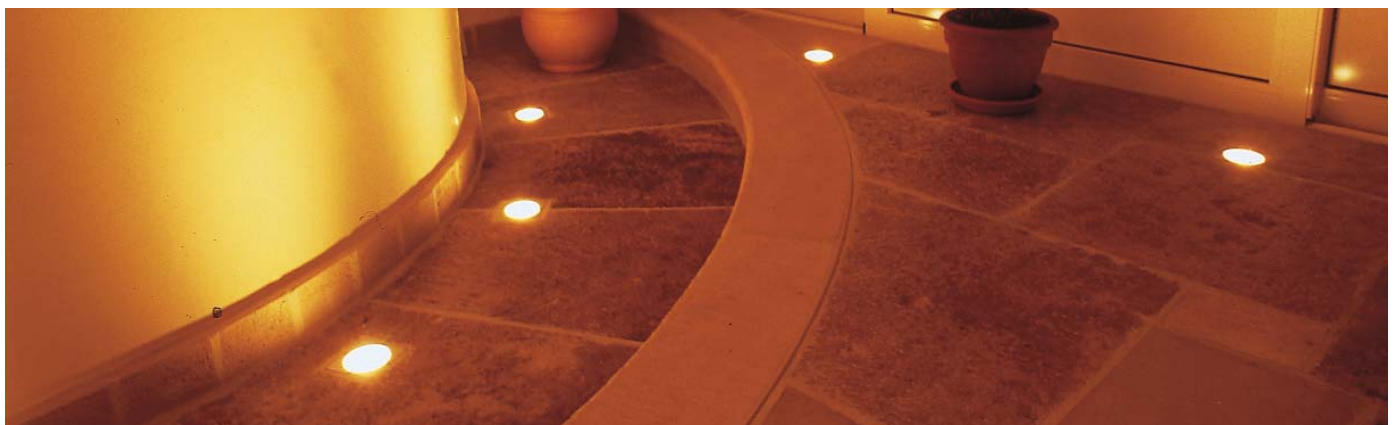



WO - op aanvraag wartelingang onderaan - sur demande presse-étoupe en bas - on request PG gland at the bottom - auf Anfrage PG Verschraubung unten

1112./.. - ETNA

~230V IP66 2,1000 0,5 m 05.10.02



floorlight - with transformer  
Bodenleuchte - mit Trafo

**Lamptype**

◁ QR-CB 51 GU5,3/GX5,3 (1) 50W 12V

**Dimensions**

↔ L240xB125xH135

∩ 135

⚡ 5mm glass - Glas

**Options**

■ S1139.5/.. - SUPPLEMENT SQUARE GLASS

build-in

Fixed	Directional
1111.ALU	1112.ALU
1111.INOX	1112.INOX
1111.MESS	1112.MESS

1147./.. - ETNA

~230V IP66 0,5 m 05.10.02



floorlight - with transformer  
Bodenleuchte - mit Trafo

**Lamptype**

◁ QR-CB 51 GU5,3/GX5,3 (1) 50W 12V

**Dimensions**

↔ L240xB125xH135

∩ 135

⚡ 5mm glass - Glas

**Options**

■ S1139.5/.. - SUPPLEMENT SQUARE GLASS

build-in

Fixed	Directional
1147.ALU	1148.ALU
1147.INOX	1148.INOX
1147.MESS	1148.MESS

## INDOOR | Floorlights | ETNA



WO - op aanvraag wartelingang onderaan - sur demande presse-étoupe en bas - on request PG gland at the bottom - auf Anfrage PG Verschraubung unten

1157../... - ETNA

~230V



IP66



0,5 m



05.10.02



floorlight with cover plate on the floor - with transformer  
Bodenleuchte mit Abdeckplatte auf dem Boden - mit Trafo

### Lamptype

QR-CB 51 GU5,3/GX5,3 (1) 50W 12V

### Dimensions

L240xB125xH135

135

5mm glass - Glas

build-in

Fixed	Directional
1157.130.INOX	1158.130.INOX
1157.130.MESS	1158.130.MESS
1157.150.INOX	1158.150.INOX
1157.150.MESS	1158.150.MESS



Niet afdekken met brandbare voorwerpen - Niet met blote voeten op grondspot lopen  
Ne pas couvrir avec des objets inflammables - Ne marchez pas pieds nus sur le spot de sol  
Do not cover with flammable objects - Do not walk on the ground light with bare feet  
Nicht mit entzündlichen Objekten abdecken - Nicht mit nackten Füßen auf Bodenleuchte laufen



**STAINLESS STEEL 316**

**Ø65-70**

301V/.. P.508 302V/.. P.508 303V/.. P.508 300V/./12V P.508



301V.230V/.. P.509 302V.230V/.. P.509 303V.230V/.. P.509 300V/./230V P.509



202/.. P.512 202.B/.. P.512 102H/.. P.513 101H/.. P.513 201/.. P.513



**UNIVERSAL SYSTEM**

**Ø65                      Ø80**

PICO20/.. P.510 PICO50/.. P.510 ARIA/.. P.510 PICO50/./LN P.511 PICO50.E550/./LN



DIVA35/.. P.510 DIVA50/.. P.511 CAMBIO/.. P.511 DIVA50/./LN P.512 DIVA50.E550/./LN



**CROSS**

**92x92**

CROSS50/.. P.513



101H/..	513
102H/..	513
201/..	513
202/.. - 202.B/..	512
301V/.. - 302V/.. - 303V/..	508, 509
ARIA/..	510
CAMBIO/..	511
CROSS50/..	513
DIVA35/..	510
DIVA50/..	511
DIVA50.E550/./LN - DIVA50/./LN	512
PICO20/..	510
PICO50/..	510
PICO50.E550/./LN - PICO50/./LN	511



Downlights outdoor

## OUTDOOR | Downlights | Ø65-70 INOX 316 | FITTING

Adjust the wattage to the type of ceiling (concrete, wood, PVC, etc)  
Wattleistung auf den Typ der Decke abstimmen (Beton, Holz, PVC, usw)

### 301V/.. - Ø65-70 INOX 316

~12V S2 IP20 0,1409 0,5 m 05.10.02



downlight - round - fixed - without transformer  
Einbaustrahler - rund - fest - ohne Trafo

#### Lamptype

QR-CB 51 GU5,3/GX5,3 (1) 50W 12V

#### Dimensions

Ø85xH55

Ø65-70 75

#### Options

S6.65/.. - PLASTERKIT

#### Ref

301V.5  
301V.5B  
301V.5BB  
301V.31  
301V.32  
301V.33

#### build-in

Code 5BB for application in coastal areas!!  
Kode 5BB anzuwenden in der Küstengegend!!

### 302V/.. - Ø65-70 INOX 316

~12V S2 IP20 0,1400 0,5 m 05.10.02



downlight - round - fixed - without transformer  
Einbaustrahler - rund - fest - ohne Trafo

#### Lamptype

QR-CB 51 GU5,3/GX5,3 (1) 50W 12V

#### Dimensions

Ø85xH55

Ø65-70 75

#### Options

S6.65/.. - PLASTERKIT

#### Ref

302V.5  
302V.5B  
302V.5BB  
302V.31  
302V.32  
302V.33

#### build-in

Code 5BB for application in coastal areas!!  
Kode 5BB anzuwenden in der Küstengegend!!

### 303V/.. - Ø65-70 INOX 316

~12V S2 IP20 0,1436 0,5 m 05.10.02



downlight - square - fixed - without transformer  
Einbaustrahler - viereckig - fest - ohne Trafo

#### Lamptype

QR-CB 51 GU5,3/GX5,3 (1) 50W 12V

#### Dimensions

L85xB85xH55

Ø65-70 75

#### Options

S6.65/.. - PLASTERKIT

#### Ref

303V.5  
303V.5B  
303V.5BB  
303V.31  
303V.32  
303V.33

#### build-in

Code 5BB for application in coastal areas!!  
Kode 5BB anzuwenden in der Küstengegend!!

### 300V/./12V - FITTING

~12V IP44 0,0400 1 m 05.10.02



supplement for downlight - waterproof fitting  
Supplement für Einbaustrahler - wasserdichte Fassung

#### Lamptype

QR-CB 51 GU5,3/GX5,3 (1) 50W 12V

#### Ref

300V.12V



## OUTDOOR | Downlights | Ø65-70 INOX 316 | FITTING

Adjust the wattage to the type of ceiling (concrete, wood, PVC, etc)  
Wattleistung auf den Typ der Decke abstimmen (Beton, Holz, PVC, usw)

### 301V.230V/.. - Ø65-70 INOX 316

~230V  S2 IP20    0,2100  1 m  05.10.02 





downlight - round - fixed  
Einbaustrahler - rund - fest

#### Lamptype

 QPAR 51 GU10 (1) 50W 230V  
or  QPAR 51 GU10 (1) 11W 230V

#### Dimensions

 Ø85xH85  
 Ø65-70  100

#### Options

S6.65/.. - PLASTERKIT

#### Ref

301V.230V.5  
301V.230V.5B  
301V.230V.5BB  
301V.230V.31  
301V.230V.32  
301V.230V.33

**build-in**  
Code 5BB for application in coastal areas!!  
Kode 5BB anzuwenden in der Küstengegend!!

### 302V.230V/.. - Ø65-70 INOX 316

~230V  S2 IP20    0,2100  1 m  05.10.02 





downlight - round - fixed  
Einbaustrahler - rund - fest

#### Lamptype

 QPAR 51 GU10 (1) 50W 230V  
or  QPAR 51 GU10 (1) 11W 230V

#### Dimensions

 Ø85xH85  
 Ø65-70  100

#### Options

S6.65/.. - PLASTERKIT

#### Ref

302V.230V.5  
302V.230V.5B  
302V.230V.5BB  
302V.230V.31  
302V.230V.32  
302V.230V.33

**build-in**  
Code 5BB for application in coastal areas!!  
Kode 5BB anzuwenden in der Küstengegend!!

### 303V.230V/.. - Ø65-70 INOX 316

~230V  S2 IP20    0,2300  1 m  05.10.02 





downlight - square - fixed  
Einbaustrahler - viereckig - fest

#### Lamptype

 QPAR 51 GU10 (1) 50W 230V  
or  QPAR 51 GU10 (1) 11W 230V

#### Dimensions

 L85xB85xH85  
 Ø65-70  100

#### Options

S6.65/.. - PLASTERKIT

#### Ref

303V.230V.5  
303V.230V.5B  
303V.230V.5BB  
303V.230V.31  
303V.230V.32  
303V.230V.33

**build-in**  
Code 5BB for application in coastal areas!!  
Kode 5BB anzuwenden in der Küstengegend!!

### 300V../230V - FITTING

~230V  IP44    0,0400  1 m  05.10.02 



supplement for downlight - waterproof fitting  
Supplement für Einbaustrahler - wasserdichte Fassung

#### Lamptype

 QPAR 51 GU10 (1) 50W 230V  
or  QPAR 51 GU10 (1) 11W 230V

#### Ref

300V.230V

## OUTDOOR | Downlights | Ø65 | Ø80

Adjust the wattage to the type of ceiling (concrete, wood, PVC, etc)  
Wattleistung auf den Typ der Decke abstimmen (Beton, Holz, PVC, usw)

### PICO20/.. - Ø65

~12V S2 IP20 0,1654 0,5 m



downlight - round - fixed - without transformer  
Einbaustrahler - rund - fest - ohne Trafo

#### Lamptype

QR-CB 35 GU4/GZ4 (1) 20W 12V

#### Dimensions

Ø75xH43  
 Ø65 63

#### Options

S6.65/.. - PLASTERKIT

#### Ref

PICO20.5  
PICO20.5B  
PICO20.31  
PICO20.32  
PICO20.33

build-in  
Max. 20W

### DIVA35/.. - Ø65

~12V S2 IP20 0,1556 0,5 m



downlight - round - directional - without transformer  
Einbaustrahler - rund - schwenkbar - ohne Trafo

#### Lamptype

QR-CB 35 GU4/GZ4 (1) 35W 12V

#### Dimensions

Ø75xH48  
 Ø65 68

#### Options

S6.65/.. - PLASTERKIT

#### Ref

DIVA35.5  
DIVA35.5B  
DIVA35.20 (MESSING)  
DIVA35.31  
DIVA35.32  
DIVA35.33

build-in

### PICO50/.. - Ø80

~12V S2 IP20 0,1787 0,5 m



downlight - round - fixed - without transformer  
Einbaustrahler - rund - fest - ohne Trafo

#### Lamptype

QR-CB 51 GU5,3/GX5,3 (1) 50W 12V

#### Dimensions

Ø89xH55  
 Ø80 75

#### Options

S1/.. - TORSION SPRINGS  
S6.80/.. - PLASTERKIT

#### Ref

PICO50.5  
PICO50.5B  
PICO50.5BB  
PICO50.20 (MESSING)  
PICO50.21B  
PICO50.31  
PICO50.32  
PICO50.33

build-in

### ARIA/.. - Ø80

~230V S2 IP20 0,2206 1 m



downlight - round - fixed  
Einbaustrahler - rund - fest

#### Lamptype

QPAR 51 GU10 (1) 50W 230V  
or QPAR 51 GU10 (1) 11W 230V

#### Dimensions

Ø90xH90  
 Ø80 110

#### Options

S1/.. - TORSION SPRINGS  
S6.80/.. - PLASTERKIT

#### Ref

ARIA.5  
ARIA.5B  
ARIA.5BB

build-in

# OUTDOOR | Downlights | Ø80 | Ø80 PUNCHED

Adjust the wattage to the type of ceiling (concrete, wood, PVC, etc)  
Wattleistung auf den Typ der Decke abstimmen (Beton, Holz, PVC, usw)

## DIVA50/.. - Ø80

~12V S2 IP20 0,1864 0,5 m



downlight - round - directional - without transformer  
Einbaustrahler - rund - schwenkbar - ohne Trafo

### Lamptype

QR-CB 51 GU5,3/GX5,3 (1) 50W 12V

### Dimensions

Ø89xH62  
 Ø80 135

### Options

S1/.. - TORSION SPRINGS  
S6.80/.. - PLASTERKIT

### Ref

DIVA50.5  
DIVA50.5B  
DIVA50.5BB  
DIVA50.21B  
DIVA50.31  
DIVA50.32  
DIVA50.33

build-in

## CAMBIO/.. - Ø80

~230V S2 IP20 0,2642 1 m



downlight - round - directional  
Einbaustrahler - rund - schwenkbar

### Lamptype

QPAR 51 GU10 (1) 50W 230V  
or QPAR 51 GU10 (1) 11W 230V

### Dimensions

Ø90xH115  
 Ø80 135

### Options

S1/.. - TORSION SPRINGS  
S6.80/.. - PLASTERKIT

### Ref

CAMBIO.5  
CAMBIO.5B  
CAMBIO.5BB

build-in

## PICO50/..LN - Ø80 PUNCHED

~12V S2 IP20 0,1180 0,5 m



downlight punched - round - fixed - without transformer  
Einbaustrahler gestanz - rund - fest - ohne Trafo

### Lamptype

QR-CB 51 GU5,3/GX5,3 (1) 50W 12V

### Dimensions

Ø89xH55  
 Ø80 75

### Options

S6.80/.. - PLASTERKIT

### Ref

PICO50.5.LN  
PICO50.5B.LN  
PICO50.5BB.LN  
PICO50.30.LN (ROOD KOPER)

build-in  
not compatible with adaption ring and torsion springs!  
nicht verwendbar mit Adapterring und Torsionfedern!

## PICO50.ES50/..LN - Ø80 PUNCHED

~230V S2 IP20 0,1599 1 m



downlight punched - round - fixed  
Einbaustrahler gestanz - rund - fest

### Lamptype

QPAR 51 GU10 (1) 50W 230V  
or QPAR 51 GU10 (1) 11W 230V

### Dimensions

Ø89xH115  
 Ø80 135

### Options

S6.80/.. - PLASTERKIT

### Ref

PICO50.ES50.5.LN  
PICO50.ES50.5B.LN  
PICO50.ES50.5BB.LN  
PICO50.ES50.30.LN (ROOD KOPER)

build-in  
not compatible with adaption ring and torsion springs!  
nicht verwendbar mit Adapterring und Torsionfedern!

## OUTDOOR | Downlights | Ø80 PUNCHED | Ø80 INOX 316

Adjust the wattage to the type of ceiling (concrete, wood, PVC, etc)  
Wattleistung auf den Typ der Decke abstimmen (Beton, Holz, PVC, usw)

### DIVA50/.. /LN - Ø80 PUNCHED

~12V S2 IP20 0,0678 0,5 m 05.10.02



downlight punched - round - directional - without transformer  
Einbaustrahler gestanz - rund - schwenkbar - ohne Trafo

#### Lamptype

QR-CB 51 GU5,3/GX5,3 (1) 50W 12V

#### Dimensions

Ø89xH62

Ø80 82

#### Options

S6.80/.. - PLASTERKIT

#### Ref

DIVA50.5.LN  
DIVA50.5B.LN  
DIVA50.5BB.LN  
DIVA50.30.LN (ROOD KOPER)

#### build-in

not compatible with adaption ring and torsion springs!  
nicht verwendbar mit Adapterring und Torsionfedern!

### DIVA50.ES50/.. /LN - Ø80 PUNCHED

~230V S2 IP20 0,0929 1 m 05.10.02



downlight punched - round - directional  
Einbaustrahler gestanz - rund - schwenkbar

#### Lamptype

QPAR 51 GU10 (1) 50W 230V

or QPAR 51 GU10 (1) 11W 230V

#### Dimensions

Ø89xH115

Ø80 135

#### Options

S6.80/.. - PLASTERKIT

#### Ref

DIVA50.ES50.5.LN  
DIVA50.ES50.5B.LN  
DIVA50.ES50.5BB.LN  
DIVA50.ES50.30.LN (ROOD KOPER)

#### build-in

not compatible with adaption ring and torsion springs!  
nicht verwendbar mit Adapterring und Torsionfedern!

### 202/.. - Ø80 INOX 316

~230V S1 IP20 0,2000 0,5 m 05.10.02



downlight - round - fixed  
Einbaustrahler - rund - fest

#### Lamptype

R63 E27 (1) 60W 230V

#### Dimensions

Ø94xH120

Ø80 140

#### Options

S6.80/.. - PLASTERKIT

#### Ref

202.5  
202.5B  
202.5BB  
202.31  
202.32  
202.33

#### build-in

### 202.B/.. - Ø80 INOX 316

~230V S1 IP20 0,2000 1 m 05.10.02



downlight - round - fixed  
Einbaustrahler - rund - fest

#### Lamptype

QPAR 20 E27 (1) 50W 230V

#### Dimensions

Ø94xH120

Ø80 140

#### Options

S6.80/.. - PLASTERKIT

#### Ref

202.B.5  
202.B.5B  
202.B.5BB  
202.B.31  
202.B.32  
202.B.33

#### build-in

# OUTDOOR | Downlights | Ø80 INOX 316 | Ø110 INOX 316 | 92x92 INOX 316

Adjust the wattage to the type of ceiling (concrete, wood, PVC, etc)  
Wattleistung auf den Typ der Decke abstimmen (Beton, Holz, PVC, usw)

## 102H/.. - Ø80 INOX 316

~230V  S1 IP44    0,4350  0,5 m  05.10.02 



downlight - round - fixed  
Einbaustrahler - rund - fest



### Ref

102H.5  
102H.5B  
102H.5BB  
102H.31  
102H.32  
102H.33

### Lamptype

 R63 E27 (1) 60W 230V

### Dimensions

 Ø94xH155  
 Ø80  175

### Options

S6.80/.. - PLASTERKIT

build-in

## 101H/.. - Ø110 INOX 316

~230V  S1 IP44    0,4117  1 m  05.10.02 



downlight - round - fixed  
Einbaustrahler - rund - fest



### Ref

101H.5  
101H.5B  
101H.5BB  
101H.31  
101H.32  
101H.33

### Lamptype

 QPAR 30 E27 (1) 75W 230V

### Dimensions

 Ø130xH155  
 Ø110  175

build-in

## 201/.. - Ø110 INOX 316

~230V  S1 IP20    0,2350  1 m  05.10.02 



downlight - round - fixed  
Einbaustrahler - rund - fest



### Ref

201.5  
201.5B  
201.5BB  
201.31  
201.32  
201.33

### Lamptype

 QPAR 30 E27 (1) 75W 230V

### Dimensions

 Ø130xH130  
 Ø110  150

build-in

## CROSS50/.. - 92x92 INOX 316

~12V   S2 IP20    0,3833  0,5 m  05.10.02 



downlight - square - directional - without transformer  
Einbaustrahler - viereckig - schwenkbar - ohne Trafo



### Ref

CROSS50.5  
CROSS50.5B  
CROSS50.5BB

### Lamptype

 QR-CB 51 GU5,3/GX5,3 (1) 50W 12V

### Dimensions

 L100xB100xH79  
 92x92  100

### Options

S9.92/.. - PLASTERKIT

build-in



OUTDOOR | In-ground luminaires

1114/..	558	2220.9/..	522	2313.9.150/..	540
1114GL/..	558	2222.5.130/..	523	2314.5/..	531
1115.100.5/..	552	2222.5.160/..	523	2314.9/..	531
1115.100.9/..	552	2222.9.130/..	523	2317.5/..	536
1115.135.5/..	555	2222.9.160/..	523	2317.9/..	536
1115.135.9/..	555	2223.5/..	538	2318.24V.5/..	537
1129.180/..	560	2223.9/..	538	2318.24V.9/..	537
1130.150/..	560	2225.5.130/..	538	2318.230V.5/..	537
1134/..	555	2225.5.150/..	539	2318.230V.9/..	537
1135.5/..	549	2225.9.130/..	539	2320.24V/..	516
1135.9/..	549	2225.9.150/..	539	2320.230V/..	516
1136.5/..	550	2227.5/..	519	2321.24V/..	516
1136.5.135/..	555	2227.9/..	520	2321.230V/..	516
1136.9/..	550	2229.5/..	520	2324.24V.5/..	542
1136.9.135/..	556	2229.9/..	520	2324.24V.9/..	542
1137.5/..	559	2245.5/..	529	2324.230V.5/..	541
1137.9/..	559	2245.9/..	529	2324.230V.9/..	541
1138.5/..	551	2247.5/..	544	2325.24V.5/..	534
1138.5.135/..	556	2247.9/..	544	2325.24V.9/..	534
1138.9/..	551	2257.5/./..	547	2325.230V.5/..	534
1138.9.135/..	557	2257.9/./..	547	2325.230V.9/..	534
1141.160/..	560	2300.5/..	528	2327.5/..	530
1142.130/..	561	2300.9/..	529	2327.9/..	530
1143/..	549	2302.5/..	545	2347.5/..	546
1145/..	550	2302.9/..	545	2347.9/..	546
1149.130/..	560	2304.12V/..	557	2357.5/./..	547
1150/..	554	2304.230V/..	558	2357.9/./..	548
1180.9/..	566	2305.24V.5/..	519	2360.9/..	561
1181.9/..	566	2305.24V.9/..	519	2361.9/..	561
1182/..	567	2305.230V.5/..	518	2363.9/..	561
2200.5/..	517	2305.230V.9/..	519	2364.9/..	562
2200.9/..	517	2306.5/..	518	2365.9/..	562
2202.5/..	517	2306.9/..	518	2367.9/..	562
2202.9/..	518	2307.5/..	533	2368.9/..	562
2203.5/..	532	2307.9/..	533	2369.9/..	563
2203.9/..	532	2308.5/..	550	2370.9/..	563
2205.5/..	533	2309.5/..	520	2371.9/..	563
2205.9/..	533	2309.9/..	521	2374.9/..	563
2206/..	527	2310.24V.5/..	521	2375.9/..	564
2207/..	527	2310.24V.9/..	522	2376.9/..	564
2208/..	527	2310.230V.5/..	521	2377.9/..	564
2209.5/..	528	2310.230V.9/..	521	2380.9/..	564
2209.9/..	528	2311.5.130/..	524	2381.9/..	565
2211.5/..	543	2311.5.160/..	524	2383.9/..	565
2211.9/..	543	2311.9.130/..	524	2384.9/..	565
2213/..	527	2311.9.160/..	524	2385.9/..	565
2214.5/./..	530	2312.24V.5/..	526	2386.9/..	566
2214.9/./..	531	2312.24V.9/..	526	2387.9/..	566
2217.5/./..	535	2312.230V.5/..	525	WO	558
2217.9/./..	535	2312.230V.9/..	525		
2219.5/..	536	2313.5.130/..	539		
2219.9/..	536	2313.5.150/..	540		
2220.5/..	522	2313.9.130/..	540		

behuizing in inox + glas 5 of 9mm dik - housing stainless steel + glass 5 or 9mm thick - boîtier en inox + verre 5 ou 9mm épais  
 Gehäuse in Edelstahl + Glas 5 oder 9mm dick

**LAVA**

2200.5/.. P.517    2203.5/.. P.532



**ETNA**

2209.5/.. P.528    2211.5/.. P.543    2300.5/.. P.528    2302.5/.. P.545



**COVER = WITH THE FLOOR**

2227.5/.. P.519    2217.5/./.. P.535



2245.5/.. P.529    2247.9/.. P.544    2327.9/.. P.530    2347.5/.. P.546



**COVER ON THE FLOOR**

2220.5/.. P.522    2223.5/.. P.538



2214.5/./.. P.530    2257.5/./.. P.547



**ORIENTATION LIGHTING**

2206/.. P.527    2208/.. P.527



2213/.. P.527



**LAVA LED CASSETTE**

**TYPE A**

2320.230V/.. P.516



**TYPE B**

2320.24V/.. P.516



**TYPE C**

2321.230V/.. P.516



**TYPE D**

2321.24V/.. P.516



**LAVA GRANDE**

2360.9/.. P.561



2364.9/.. P.562



2368.9/.. P.562



2374.9/.. P.563



2380.9/.. P.564



2385.9/.. P.565



# OUTDOOR | In-ground luminaires | TYPE A|C : LED CASSETTE 230V | TYPE B|C : LED CASSETTE 24V-DC



WO - op aanvraag wartelingang onderaan - sur demande presse-étoupe en bas - on request PG gland at the bottom - auf Anfrage PG Verschraubung unten

## 2320.230V/.. - TYPE A : LED CASSETTE 230V 3,6W IP65

~230V IP65



accessories for garden lighting - fixed - not dimmable  
Zubehör für Gartenleuchten - fest - nicht dimmbar

Ref  
2320.230V.NW

### Lamptype

led 230V . (1) 3,6W 230V

### Dimensions

↔ Ø70

### Options

LAVA-ETNA LED  
TOLEDO FLOOR OR WALL

Niko-Erea LED - NW 4000K

## 2320.24V/.. - TYPE B : LED CASSETTE 24V-DC 3,6W IP65

=24V-DC IP65

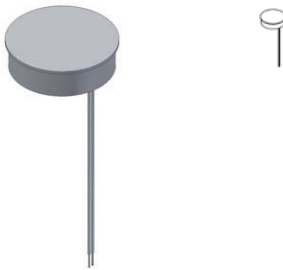

accessories for garden lighting - fixed - not dimmable - without transformer  
Zubehör für Gartenleuchten - fest - nicht dimmbar - ohne Trafo

Ref  
2320.24V.NW

### Lamptype

led 24V-DC . (1) 3,6W 24V-DC

### Dimensions

↔ Ø70

### Options

LAVA-ETNA LED  
TOLEDO FLOOR OR WALL

Niko-Erea LED - NW 4000K - parallel connection  
Parallelschaltung

## 2321.230V/.. - TYPE C : LED CASSETTE 230V 4W IP65

~230V IP65



accessories for floorlight - directional - not dimmable  
Zubehör für Bodenleuchte - schwenkbar - nicht dimmbar

Ref  
2321.230V.NW

### Lamptype

led 230V . (1) 4W 230V

### Dimensions

↔ Ø70  $\wedge$  120° reflector

Niko-Erea LED - NW4000K - other °angle reflector on demand  
andere °Winkel Reflektor auf Anfrage

## 2321.24V/.. - TYPE D : LED CASSETTE 24V-DC 4W IP65

=24V-DC IP65



accessories for floorlight - directional - dimmable - without transformer  
Zubehör für Bodenleuchte - schwenkbar - abblendbar - ohne Trafo

Ref  
2321.24V.NW

### Lamptype

led 24V-DC . (1) 4W 24V-DC

### Dimensions

↔ Ø70  $\wedge$  120° reflector

Niko-Erea LED - NW4000K - other °angle reflector on demand - parallel connection - PWM dimmable  
andere °Winkel Reflektor auf Anfrage - Parallelschaltung - PWM abblendbar





WO - op aanvraag wartelingang onderaan - sur demande presse-étoupe en bas - on request PG gland at the bottom - auf Anfrage PG Verschraubung unten

2200.5./.. - LAVA

~12V IP66 0,5 m



floorlight - without transformer  
Bodenleuchte - ohne Trafo

Lamp type

QR-CB 51 GU5,3/GX5,3 (1) 50W 12V

Dimensions

Ø100xH135  
Ø102 √L 140  
5mm glass - Glas

Fixed	Directional
2200.5.ALU	2201.5.ALU
2200.5.INOX	2201.5.INOX
2200.5.MESS	2201.5.MESS

build-in

2200.9./.. - LAVA

~12V IP66 0,5 m



floorlight - without transformer  
Bodenleuchte - ohne Trafo

Lamp type

QR-CB 51 GU5,3/GX5,3 (1) 50W 12V

Dimensions

Ø100xH135  
Ø102 √L 140  
9mm glass - Glas

Fixed	Directional
2200.9.ALU	2201.9.ALU
2200.9.INOX	2201.9.INOX
2200.9.MESS	2201.9.MESS

build-in

2202.5./.. - LAVA

~230V IP66 1,2933 05.10.02



floorlight - 230V  
Bodenleuchte - 230V

Lamp type

QPAR 51 GU10 (1) 35W 230V  
or QPAR 51 GU10 (1) 11W 230V

Dimensions

Ø100xH135  
Ø102 √L 140  
5mm glass - Glas

Ref

2202.5.ALU  
2202.5.MESS  
2202.5.INOX

build-in

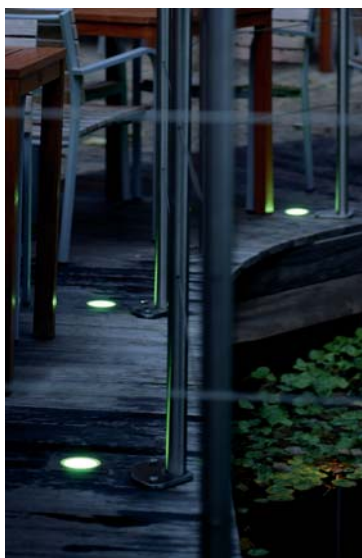

In-ground luminaires outdoor

# OUTDOOR | In-ground luminaires | LAVA



WO - op aanvraag wartelingang onderaan - sur demande presse-étoupe en bas - on request PG gland at the bottom - auf Anfrage PG Verschraubung unten

## 2202.9/.. - LAVA

~230V



floorlight - 230V  
Bodenleuchte - 230V

### Lamp type

QPAR 51 GU10 (1) 35W 230V  
or QPAR 51 GU10 (1) 11W 230V

### Dimensions

Ø100xH135  
Ø102 √ 140  
9mm glass - Glas

### Ref

2202.9.ALU  
2202.9.MESS  
2202.9.INOX

build-in

## 2306.5/.. - LAVA

~230V



floorlight - microlynx  
Bodenleuchte - microlynx

### Lamp type

TC-FSE GX53 (1) 9W 230V

### Dimensions

Ø100xH105  
Ø102 √ 110  
5mm glass - Glas

### Ref

2306.5.ALU  
2306.5.MESS  
2306.5.INOX

build-in

## 2306.9/.. - LAVA

~230V



floorlight - microlynx  
Bodenleuchte - microlynx

### Lamp type

TC-FSE GX53 (1) 9W 230V

### Dimensions

Ø100xH105  
Ø102 √ 110  
9mm glass - Glas

### Ref

2306.9.ALU  
2306.9.MESS  
2306.9.INOX

build-in

## 2305.230V.5/.. - LAVA

~230V



floorlight  
Bodenleuchte

### Dimensions

Ø100xH135  
Ø102  
5mm glass - Glas

A Fixed	C Directional
led 230V . (1) 3,6W / 230V	led 230V . (1) 4W / 230V
2305.A.5.ALU	2305.C.5.ALU
2305.A.5.INOX	2305.C.5.INOX
2305.A.5.MESS	2305.C.5.MESS

build-in

# OUTDOOR | In-ground luminaires | LAVA | LAVA = even with the floor



WO - op aanvraag wartelingang onderaan - sur demande presse-étoupe en bas - on request PG gland at the bottom - auf Anfrage PG Verschraubung unten

## 2305.230V.9/.. - LAVA

~230V



floorlight  
Bodenleuchte

### Dimensions

- Ø100xH135
- 📏 Ø102 √ 140
- 🔍 9mm glass - Glas

A Fixed	C Directional
led 230V . (1) 3,6W / 230V	led 230V . (1) 4W / 230V
2305.A.9.ALU	2305.C.9.ALU
2305.A.9.INOX	2305.C.9.INOX
2305.A.9.MESS	2305.C.9.MESS

build-in

## 2305.24V.5/.. - LAVA

=24V-DC



floorlight - without transformer  
Bodenleuchte - ohne Trafo

- 📏 Ø102 √ 140
- 🔍 5mm glass - Glas

B Fixed	D Directional
led 24V-DC . (1) 3,6W / 24V-DC	led 24V-DC . (1) 4W / 24V-DC
2305.B.5.ALU	2305.D.5.ALU
2305.B.5.INOX	2305.D.5.INOX
2305.B.5.MESS	2305.D.5.MESS

build-in  
parallel connection  
Parallelschaltung

## 2305.24V.9/.. - LAVA

=24V-DC



floorlight - without transformer  
Bodenleuchte - ohne Trafo

- 📏 Ø102 √ 140
- 🔍 9mm glass - Glas

B Fixed	D Directional
led 24V-DC . (1) 3,6W / 24V-DC	led 24V-DC . (1) 4W / 24V-DC
2305.B.9.ALU	2305.D.9.ALU
2305.B.9.INOX	2305.D.9.INOX
2305.B.9.MESS	2305.D.9.MESS

build-in  
parallel connection  
Parallelschaltung

## 2227.5/.. - LAVA = even with the floor

~12V



floorlight with build-in frame even with the floor - without transformer  
Bodenleuchte mit Einbaurahmen gleich mit dem Boden - ohne Trafo

### Lamp type

🔊 QR-CB 51 GU5,3/GX5,3 (1) 50W 12V

### Dimensions

- Ø103xH135
- 📏 Ø105 √ 140
- 🔍 5mm glass - Glas

Fixed	Directional
2227.5.ALU	2228.5.ALU
2227.5.INOX	2228.5.INOX
2227.5.MESS	2228.5.MESS

build-in

In-ground luminaires outdoor

## OUTDOOR | In-ground luminaires | LAVA = even with the floor



WO - op aanvraag wartelingang onderaan - sur demande presse-étoupe en bas - on request PG gland at the bottom - auf Anfrage PG Verschraubung unten

### 2227.9/.. - LAVA = even with the floor

~12V



floorlight with build-in frame even with the floor - without transformer  
Bodenleuchte mit Einbaurahmen gleich mit dem Boden - ohne Trafo

#### Lamp type

QR-CB 51 GU5,3/GX5,3 (1) 50W 12V

#### Dimensions

Ø103xH135  
Ø105 √L 140  
9mm glass - Glas

build-in

Fixed	Directional
2227.9.ALU	2228.9.ALU
2227.9.INOX	2228.9.INOX
2227.9.MESS	2228.9.MESS

### 2229.5/.. - LAVA = even with the floor

~230V



floorlight with build-in frame even with the floor - 230V  
Bodenleuchte mit Einbaurahmen gleich mit dem Boden - 230V

#### Lamp type

QPAR 51 GU10 (1) 35W 230V  
or QPAR 51 GU10 (1) 11W 230V

#### Dimensions

Ø103xH135  
Ø105 √L 140  
5mm glass - Glas

build-in

#### Ref

2229.5.ALU  
2229.5.MESS  
2229.5.INOX

### 2229.9/.. - LAVA = even with the floor

~230V



floorlight with build-in frame even with the floor - 230V  
Bodenleuchte mit Einbaurahmen gleich mit dem Boden - 230V

#### Lamp type

QPAR 51 GU10 (1) 35W 230V  
or QPAR 51 GU10 (1) 11W 230V

#### Dimensions

Ø103xH135  
Ø105 √L 140  
9mm glass - Glas

build-in

#### Ref

2229.9.ALU  
2229.9.MESS  
2229.9.INOX

### 2309.5/.. - LAVA = even with the floor

~230V



floorlight with build-in frame even with the floor - microlynx  
Bodenleuchte mit Einbaurahmen gleich mit dem Boden - microlynx

#### Lamp type

TC-FSE GX53 (1) 9W 230V

#### Dimensions

Ø103xH105  
Ø105 √L 110  
5mm glass - Glas

build-in

#### Ref

2309.5.ALU  
2309.5.MESS  
2309.5.INOX

# OUTDOOR | In-ground luminaires | LAVA = even with the floor



WO - op aanvraag wartelingang onderaan - sur demande presse-étoupe en bas - on request PG gland at the bottom - auf Anfrage PG Verschraubung unten

## 2309.9/.. - LAVA = even with the floor

~230V



floorlight with build-in frame even with the floor - microlynx  
Bodenleuchte mit Einbaurahmen gleich mit dem Boden - microlynx

### Lamptype

TC-FSE GX53 (1) 9W 230V

### Dimensions

- Ø103xH105
- Ø105 √L 110
- 9mm glass - Glas

### Ref

2309.9.ALU  
2309.9.MESS  
2309.9.INOX

build-in

## 2310.230V.5/.. - LAVA = even with the floor

~230V



floorlight with build-in frame even with the floor  
Bodenleuchte mit Einbaurahmen gleich mit dem Boden

### Dimensions

- Ø103xH135
- Ø105 √L 140
- 5mm glass - Glas

A Fixed	C Directional
led 230V . (1) 3,6W / 230V	led 230V . (1) 4W / 230V
2310.A.5.ALU	2310.C.5.ALU
2310.A.5.INOX	2310.C.5.INOX
2310.A.5.MESS	2310.C.5.MESS

build-in

## 2310.230V.9/.. - LAVA = even with the floor

~230V



floorlight with build-in frame even with the floor  
Bodenleuchte mit Einbaurahmen gleich mit dem Boden

### Dimensions

- Ø103xH105
- Ø105 √L 140
- 9mm glass - Glas

A Fixed	C Directional
led 230V . (1) 3,6W / 230V	led 230V . (1) 4W / 230V
2310.A.9.ALU	2310.C.9.ALU
2310.A.9.INOX	2310.C.9.INOX
2310.A.9.MESS	2310.C.9.MESS

build-in

## 2310.24V.5/.. - LAVA = even with the floor



floorlight with build-in frame even with the floor - without transformer  
Bodenleuchte mit Einbaurahmen gleich mit dem Boden - ohne Trafo

### Dimensions

- Ø103xH135
- Ø105 √L 140
- 5mm glass - Glas

B Fixed	D Directional
led 24V-DC . (1) 3,6W / 24V-DC	led 24V-DC . (1) 4W / 24V-DC
2310.B.5.ALU	2310.D.5.ALU
2310.B.5.INOX	2310.D.5.INOX
2310.B.5.MESS	2310.D.5.MESS

build-in  
parallel connection  
Parallelschaltung

In-ground luminaires outdoor

**OUTDOOR | In-ground luminaires | LAVA = even with the floor | LAVA cover on the floor**



WO - op aanvraag wartelingang onderaan - sur demande presse-étoupe en bas - on request PG gland at the bottom - auf Anfrage PG Verschraubung unten

**2310.24V.9/.. - LAVA = even with the floor**



floorlight with build-in frame even with the floor - without transformer  
Bodenleuchte mit Einbaurahmen gleich mit dem Boden - ohne Trafo

**Dimensions**

- ↔ Ø103xH135
- 📏 Ø105 √L 140
- 🔍 9mm glass - Glas

B Fixed	D Directional
led 24V-DC . (1) 3,6W / 24V-DC	led 24V-DC . (1) 4W / 24V-DC
2310.B.9.ALU	2310.D.9.ALU
2310.B.9.INOX	2310.D.9.INOX
2310.B.9.MESS	2310.D.9.MESS

build-in  
parallel connection  
Parallelschaltung

**2220.5/.. - LAVA cover on the floor**

~12V



floorlight with cover plate on the floor - without transformer  
Bodenleuchte mit Abdeckplatte auf dem Boden - ohne Trafo

**Lamptype**

🔊 QR-CB 51 GU5,3/GX5,3 (1) 50W 12V

**Dimensions**

- ↔ Ø130-160xH135
- 📏 Ø102 √L 140
- 🔍 5mm glass - Glas

Fixed	Directional
2220.5.130.INOX	2221.5.130.INOX
2220.5.130.MESS	2221.5.130.MESS
2220.5.160.INOX	2221.5.160.INOX
2220.5.160.MESS	2221.5.160.MESS

build-in

**2220.9/.. - LAVA cover on the floor**

~12V



floorlight with cover plate on the floor - without transformer  
Bodenleuchte mit Abdeckplatte auf dem Boden - ohne Trafo

**Lamptype**

🔊 QR-CB 51 GU5,3/GX5,3 (1) 50W 12V

**Dimensions**

- ↔ Ø130-160xH135
- 📏 Ø102 √L 140
- 🔍 9mm glass - Glas

Fixed	Directional
2220.9.130.INOX	2221.9.130.INOX
2220.9.130.MESS	2221.9.130.MESS
2220.9.160.INOX	2221.9.160.INOX
2220.9.160.MESS	2221.9.160.MESS

build-in

# OUTDOOR | In-ground luminaires | LAVA cover on the floor



WO - op aanvraag wartelingang onderaan - sur demande presse-étoupe en bas - on request PG gland at the bottom - auf Anfrage PG Verschraubung unten

## 2222.5.130/.. - LAVA cover on the floor

~230V



floorlight with cover plate on the floor - 230V  
Bodenleuchte mit Abdeckplatte auf dem Boden - 230V

### Lamptype

QPAR 51 GU10 (1) 35W 230V  
or QPAR 51 GU10 (1) 11W 230V

### Dimensions

Ø130xH135  
Ø102 √L 140  
5mm glass - Glas

### Ref

2222.5.130.MESS  
2222.5.130.INOX

build-in

## 2222.5.160/.. - LAVA cover on the floor

~230V



floorlight with cover plate on the floor - 230V  
Bodenleuchte mit Abdeckplatte auf dem Boden - 230V

### Lamptype

QPAR 51 GU10 (1) 35W 230V  
or QPAR 51 GU10 (1) 11W 230V

### Dimensions

Ø160xH135  
Ø102 √L 140  
5mm glass - Glas

### Ref

2222.5.160.MESS  
2222.5.160.INOX

build-in

## 2222.9.130/.. - LAVA cover on the floor

~230V



floorlight with cover plate on the floor - 230V  
Bodenleuchte mit Abdeckplatte auf dem Boden - 230V

### Lamptype

QPAR 51 GU10 (1) 35W 230V  
or QPAR 51 GU10 (1) 11W 230V

### Dimensions

Ø130xH135  
Ø102 √L 140  
9mm glass - Glas

### Ref

2222.9.130.MESS  
2222.9.130.INOX

build-in

## 2222.9.160/.. - LAVA cover on the floor

~230V



floorlight with cover plate on the floor - 230V  
Bodenleuchte mit Abdeckplatte auf dem Boden - 230V

### Lamptype

QPAR 51 GU10 (1) 35W 230V  
or QPAR 51 GU10 (1) 11W 230V

### Dimensions

Ø160xH135  
Ø102 √L 140  
9mm glass - Glas

### Ref

2222.9.160.MESS  
2222.9.160.INOX

build-in

In-ground luminaires outdoor

## OUTDOOR | In-ground luminaires | LAVA cover on the floor



WO - op aanvraag wartelingang onderaan - sur demande presse-étoupe en bas - on request PG gland at the bottom - auf Anfrage PG Verschraubung unten

### 2311.5.130/.. - LAVA cover on the floor

~230V



floorlight with cover plate on the floor - microlynx  
Bodenleuchte mit Abdeckplatte auf dem Boden - microlynx

#### Lamp type

TC-FSE GX53 (1) 9W 230V

#### Dimensions

→ Ø130xH105  
 Ø102 110  
 5mm glass - Glas

#### Ref

2311.5.130.MESS  
2311.5.130.INOX

build-in

### 2311.5.160/.. - LAVA cover on the floor

~230V



floorlight with cover plate on the floor - microlynx  
Bodenleuchte mit Abdeckplatte auf dem Boden - microlynx

#### Lamp type

TC-FSE GX53 (1) 9W 230V

#### Dimensions

→ Ø160xH105  
 Ø102 110  
 5mm glass - Glas

#### Ref

2311.5.160.MESS  
2311.5.160.INOX

build-in

### 2311.9.130/.. - LAVA cover on the floor

~230V



floorlight with cover plate on the floor - microlynx  
Bodenleuchte mit Abdeckplatte auf dem Boden - microlynx

#### Lamp type

TC-FSE GX53 (1) 9W 230V

#### Dimensions

→ Ø130xH105  
 Ø102 110  
 9mm glass - Glas

#### Ref

2311.9.130.MESS  
2311.9.130.INOX

build-in

### 2311.9.160/.. - LAVA cover on the floor

~230V



floorlight with cover plate on the floor - microlynx  
Bodenleuchte mit Abdeckplatte auf dem Boden - microlynx

#### Lamp type

TC-FSE GX53 (1) 9W 230V

#### Dimensions

→ Ø160xH105  
 Ø102 110  
 9mm glass - Glas

#### Ref

2311.9.160.MESS  
2311.9.160.INOX

build-in



# OUTDOOR | In-ground luminaires | LAVA cover on the floor



WO - op aanvraag wartelingang onderaan - sur demande presse-étoupe en bas - on request PG gland at the bottom - auf Anfrage PG Verschraubung unten

## 2312.230V.5/.. - LAVA cover on the floor

~230V IP66 0.5 m 05.10.02



floorlight with cover plate on the floor  
Bodenleuchte mit Abdeckplatte auf dem Boden

### Dimensions

Ø130-160xH135

Ø102 √L 140

5mm glass - Glas

A Fixed	C Directional
led 230V . (1) 3,6W / 230V	led 230V . (1) 4W / 230V
2312.130.A.5.INOX	2312.130.C.5.INOX
2312.130.A.5.MESS	2312.130.C.5.MESS
2312.160.A.5.INOX	2312.160.C.5.INOX
2312.160.A.5.MESS	2312.160.C.5.MESS

build-in

## 2312.230V.9/.. - LAVA cover on the floor

~230V IP66 0.5 m 05.10.02



floorlight with cover plate on the floor  
Bodenleuchte mit Abdeckplatte auf dem Boden

### Dimensions

Ø130-160xH135

Ø102 √L 140

9mm glass - Glas

A Fixed	C Directional
led 230V . (1) 3,6W / 230V	led 230V . (1) 4W / 230V
2312.130.A.9.INOX	2312.130.C.9.INOX
2312.130.A.9.MESS	2312.130.C.9.MESS
2312.160.A.9.INOX	2312.160.C.9.INOX
2312.160.A.9.MESS	2312.160.C.9.MESS

build-in

In-ground luminaires outdoor

## OUTDOOR | In-ground luminaires | LAVA cover on the floor



WO - op aanvraag wartelingang onderaan - sur demande presse-étoupe en bas - on request PG gland at the bottom - auf Anfrage PG Verschraubung unten

### 2312.24V.5/.. - LAVA cover on the floor

=24V-DC IP66 0,5 m 05.10.02



floorlight with cover plate on the floor - without transformer  
Bodenleuchte mit Abdeckplatte auf dem Boden - ohne Trafo

#### Dimensions

→ Ø130-160xH135

Ø102 √L 140

5mm glass - Glas

B Fixed	D Directional
led 24V-DC . (1) 3,6W / 24V-DC	led 24V-DC . (1) 4W / 24V-DC
2312.130.B.5.INOX	2312.130.D.5.INOX
2312.130.B.5.MESS	2312.130.D.5.MESS
2312.160.B.5.INOX	2312.160.D.5.INOX
2312.160.B.5.MESS	2312.160.D.5.MESS

**build-in**  
parallel connection  
Parallelschaltung

### 2312.24V.9/.. - LAVA cover on the floor

=24V-DC IP66 0,5 m 05.10.02



floorlight with cover plate on the floor - without transformer  
Bodenleuchte mit Abdeckplatte auf dem Boden - ohne Trafo

#### Dimensions

→ Ø130-160xH135

Ø102 √L 140

9mm glass - Glas

B Fixed	D Directional
led 24V-DC . (1) 3,6W / 24V-DC	led 24V-DC . (1) 4W / 24V-DC
2312.130.B.9.INOX	2312.130.D.9.INOX
2312.130.B.9.MESS	2312.130.D.9.MESS
2312.160.B.9.INOX	2312.160.D.9.INOX
2312.160.B.9.MESS	2312.160.D.9.MESS

**build-in**  
parallel connection  
Parallelschaltung

# OUTDOOR | In-ground luminaires | LAVA orientation | ETNA orientation | LAVA orientation



WO - op aanvraag wartelingang onderaan - sur demande presse-étoupe en bas - on request PG gland at the bottom - auf Anfrage PG Verschraubung unten

## 2206/.. - LAVA orientation

~12V



ambient floorlighting - fixed - without transformer  
Orientierungsbodenleuchte - fest - ohne Trafo

### Lamp type

QR-CB 51 GU5,3/GX5,3 (1) 50W 12V

### Dimensions

Ø100xH150  
Ø102 JL 95  
5mm glass - Glas

### Ref

2206.ALU  
2206.MESS  
2206.INOX

build-in

## 2207/.. - LAVA orientation

~230V



ambient floorlighting - 230V  
Orientierungsbodenleuchte - 230V

### Lamp type

QPAR 51 GU10 (1) 35W 230V  
or QPAR 51 GU10 (1) 11W 230V

### Dimensions

Ø100xH150  
Ø102 JL 95  
5mm glass - Glas

### Ref

2207.ALU  
2207.MESS  
2207.INOX

build-in

## 2213/.. - ETNA orientation

~230V



ambient floorlighting - with transformer  
Orientierungsbodenleuchte - mit Trafo

### Lamp type

QR-CB 51 GU5,3/GX5,3 (1) 50W 12V

### Dimensions

L240xB125xH190  
JL 135  
5mm glass - Glas

### Ref

2213.ALU  
2213.MESS  
2213.INOX

build-in  
60VA

## 2208/.. - LAVA orientation

~230V



ambient floorlighting - 230V  
Orientierungsbodenleuchte - 230V

### Lamp type

mini lynx longlife E27 (1) 11W 230V  
QPAR 20 E27 (1) 50W 230V

### Dimensions

Ø100xH218  
Ø102 JL 118

### Ref

2208.ALU  
2208.MESS  
2208.INOX

build-in

In-ground luminaires outdoor

# OUTDOOR | In-ground luminaires | ETNA



WO - op aanvraag wartelingang onderaan - sur demande presse-étoupe en bas - on request PG gland at the bottom - auf Anfrage PG Verschraubung unten

## 2209.5./.. - ETNA

~230V



floorlight - with transformer  
Bodenleuchte - mit Trafo

### Lamptype

QR-CB 51 GU5,3/GX5,3 (1) 50W 12V

### Dimensions

L240xB125xH135

140

5mm glass - Glas

Fixed	Directional
2209.5.ALU	2210.5.ALU
2209.5.INOX	2210.5.INOX
2209.5.MESS	2210.5.MESS

build-in

## 2209.9./.. - ETNA

~230V



floorlight - with transformer  
Bodenleuchte - mit Trafo

### Lamptype

QR-CB 51 GU5,3/GX5,3 (1) 50W 12V

### Dimensions

L240xB125xH135

140

9mm glass - Glas

Fixed	Directional
2209.9.ALU	2210.9.ALU
2209.9.INOX	2210.9.INOX
2209.9.MESS	2210.9.MESS

build-in

## 2300.5./.. - ETNA

~230V



floorlight - with transformer  
Bodenleuchte - mit Trafo

### Lamptype

QR-CB 51 GU5,3/GX5,3 (1) 50W 12V

### Dimensions

Ø100xH200

Ø102 205

5mm glass - Glas

Fixed	Directional
2300.5.ALU	2301.5.ALU
2300.5.INOX	2301.5.INOX
2300.5.MESS	2301.5.MESS

build-in

# OUTDOOR | In-ground luminaires | ETNA | ETNA = EVEN WITH THE FLOOR



WO - op aanvraag wartelingang onderaan - sur demande presse-étoupe en bas - on request PG gland at the bottom - auf Anfrage PG Verschraubung unten

## 2300.9/.. - ETNA

~230V



build-in



floorlight - with transformer  
Bodenleuchte - mit Trafo

### Lamptype

◁ QR-CB 51 GU5,3/GX5,3 (1) 50W 12V

### Dimensions

↔ Ø100xH200  
↙ Ø102 ↘ 205  
⚡ 9mm glass - Glas

Fixed	Directional
2300.9.ALU	2301.9.ALU
2300.9.INOX	2301.9.INOX
2300.9.MESS	2301.9.MESS

## 2245.5/.. - ETNA = EVEN WITH THE FLOOR

~230V



build-in



floorlight with build-in frame even with the floor - with transformer  
Bodenleuchte mit Einbaurahmen gleich mit dem Boden - mit Trafo

### Lamptype

◁ QR-CB 51 GU5,3/GX5,3 (1) 50W 12V

### Dimensions

↔ L240xB125xH135  
↙ 140  
⚡ 5mm glass - Glas

Fixed	Directional
2245.5.ALU	2246.5.ALU
2245.5.INOX	2246.5.INOX
2245.5.MESS	2246.5.MESS

## 2245.9/.. - ETNA = EVEN WITH THE FLOOR

~230V



build-in



floorlight with build-in frame even with the floor - with transformer  
Bodenleuchte mit Einbaurahmen gleich mit dem Boden - mit Trafo

### Lamptype

◁ QR-CB 51 GU5,3/GX5,3 (1) 50W 12V

### Dimensions

↔ L240xB125xH135  
↙ 140  
⚡ 9mm glass - Glas

Fixed	Directional
2245.9.ALU	2246.9.ALU
2245.9.INOX	2246.9.INOX
2245.9.MESS	2246.9.MESS

## OUTDOOR | In-ground luminaires | ETNA = even with the floor | ETNA cover on the floor



WO - op aanvraag wartelingang onderaan - sur demande presse-étoupe en bas - on request PG gland at the bottom - auf Anfrage PG Verschraubung unten

### 2327.5./.. - ETNA = even with the floor

~230V



floorlight with build-in frame even with the floor - with transformer  
Bodenleuchte mit Einbaurahmen gleich mit dem Boden - mit Trafo

#### Lamp type

QR-CB 51 GU5,3/GX5,3 (1) 50W 12V

#### Dimensions

Ø103xH200  
Ø105 √L 205  
5mm glass - Glas

build-in

Fixed	Directional
2327.5.ALU	2328.5.ALU
2327.5.INOX	2328.5.INOX
2327.5.MESS	2328.5.MESS

### 2327.9./.. - ETNA = even with the floor

~230V



floorlight with build-in frame even with the floor - with transformer  
Bodenleuchte mit Einbaurahmen gleich mit dem Boden - mit Trafo

#### Lamp type

QR-CB 51 GU5,3/GX5,3 (1) 50W 12V

#### Dimensions

Ø103xH200  
Ø105 √L 205  
9mm glass - Glas

build-in

Fixed	Directional
2327.9.ALU	2328.9.ALU
2327.9.INOX	2328.9.INOX
2327.9.MESS	2328.9.MESS

### 2214.5./.. - ETNA cover on the floor

~230V



floorlight with cover plate on the floor - with transformer  
Bodenleuchte mit Abdeckplatte auf dem Boden - mit Trafo

#### Lamp type

QR-CB 51 GU5,3/GX5,3 (1) 50W 12V

#### Dimensions

L240xB125xH135  
√L 140  
5mm glass - Glas

build-in

Fixed	Directional
2214.5.130.INOX	2215.5.130.INOX
2214.5.130.MESS	2215.5.130.MESS
2214.5.160.INOX	2215.5.160.INOX
2214.5.160.MESS	2215.5.160.MESS

## OUTDOOR | In-ground luminaires | ETNA cover on the floor



WO - op aanvraag wartelingang onderaan - sur demande presse-étoupe en bas - on request PG gland at the bottom - auf Anfrage PG Verschraubung unten

### 2214.9/./.. - ETNA cover on the floor

~230V



floorlight with cover plate on the floor - with transformer  
Bodenleuchte mit Abdeckplatte auf dem Boden - mit Trafo

#### Lamptype

QR-CB 51 GU5,3/GX5,3 (1) 50W 12V

#### Dimensions

L240xB125xH135

∅ 140

9mm glass - Glas

build-in

Fixed	Directional
2214.9.130.INOX	2215.9.130.INOX
2214.9.130.MESS	2215.9.130.MESS
2214.9.160.INOX	2215.9.160.INOX
2214.9.160.MESS	2215.9.160.MESS

### 2314.5/./.. - ETNA cover on the floor

~230V



floorlight with cover plate on the floor - with transformer  
Bodenleuchte mit Abdeckplatte auf dem Boden - mit Trafo

#### Lamptype

QR-CB 51 GU5,3/GX5,3 (1) 50W 12V

#### Dimensions

∅130-160xH200

∅102 ∅ 205

5mm glass - Glas

build-in

Fixed	Directional
2314.5.130.INOX	2315.5.130.INOX
2314.5.130.MESS	2315.5.130.MESS
2314.5.160.INOX	2315.5.160.INOX
2314.5.160.MESS	2315.5.160.MESS

### 2314.9/./.. - ETNA cover on the floor

~230V



floorlight with cover plate on the floor - with transformer  
Bodenleuchte mit Abdeckplatte auf dem Boden - mit Trafo

#### Lamptype

QR-CB 51 GU5,3/GX5,3 (1) 50W 12V

#### Dimensions

∅130-160xH200

∅102 ∅ 205

9mm glass - Glas

build-in

Fixed	Directional
2314.9.130.INOX	2315.9.130.INOX
2314.9.130.MESS	2315.9.130.MESS
2314.9.160.INOX	2315.9.160.INOX
2314.9.160.MESS	2315.9.160.MESS

## OUTDOOR | In-ground luminaires | LAVA



WO - op aanvraag wartelingang onderaan - sur demande presse-étoupe en bas - on request PG gland at the bottom - auf Anfrage PG Verschraubung unten

### 2203.5/.. - LAVA

~12V IP66 1,8650 0,5 m 05.10.02



build-in



floorlight - without transformer  
Bodenleuchte - ohne Trafo

#### Lamp type

QR-CB 51 GU5,3/GX5,3 (1) 50W 12V

#### Dimensions

L 100xB100xH135

102x102 140

5mm glass - Glas

#### Options

S1139.5/.. - SUPPLEMENT SQUARE GLASS

Fixed	Directional
2203.5.ALU	2204.5.ALU
2203.5.INOX	2204.5.INOX
2203.5.MESS	2204.5.MESS

### 2203.9/.. - LAVA

~12V IP66 0,5 m 05.10.02



build-in



floorlight - without transformer  
Bodenleuchte - ohne Trafo

#### Lamp type

QR-CB 51 GU5,3/GX5,3 (1) 50W 12V

#### Dimensions

L 100xB100xH135

102x102 140

9mm glass - Glas

#### Options

S1139.9/.. - SUPPLEMENT SQUARE GLASS

Fixed	Directional
2203.9.ALU	2204.9.ALU
2203.9.INOX	2204.9.INOX
2203.9.MESS	2204.9.MESS





WO - op aanvraag wartelingang onderaan - sur demande presse-étoupe en bas - on request PG gland at the bottom - auf Anfrage PG Verschraubung unten

2205.5/.. - LAVA

~230V



floorlight - 230V  
Bodenleuchte - 230V

Lamptype

QPAR 51 GU10 (1) 35W 230V  
or QPAR 51 GU10 (1) 11W 230V

Dimensions

L100xB100xH135  
102x102 140  
5mm glass - Glas

Options

■ S1139.5/.. - SUPPLEMENT SQUARE GLASS

Ref

2205.5.ALU  
2205.5.MESS  
2205.5.INOX

build-in

2205.9/.. - LAVA

~230V

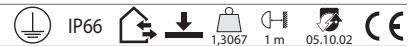

floorlight - 230V  
Bodenleuchte - 230V

Lamptype

QPAR 51 GU10 (1) 35W 230V  
or QPAR 51 GU10 (1) 11W 230V

Dimensions

L100xB100xH135  
102x102 140  
9mm glass - Glas

Options

■ S1139.9/.. - SUPPLEMENT SQUARE GLASS

Ref

2205.9.ALU  
2205.9.MESS  
2205.9.INOX

build-in

2307.5/.. - LAVA

~230V



floorlight - microlynx  
Bodenleuchte - microlynx

Lamptype

TC-FSE GX53 (1) 9W 230V

Dimensions

L100xB100xH105  
102x102 110  
5mm glass - Glas

Options

■ S1139.5/.. - SUPPLEMENT SQUARE GLASS

Ref

2307.5.ALU  
2307.5.MESS  
2307.5.INOX

build-in

2307.9/.. - LAVA

~230V

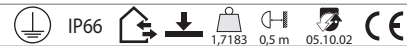

floorlight - microlynx  
Bodenleuchte - microlynx

Lamptype

TC-FSE GX53 (1) 9W 230V

Dimensions

L100xB100xH105  
102x102 110  
9mm glass - Glas

Options

■ S1139.9/.. - SUPPLEMENT SQUARE GLASS

Ref

2307.9.ALU  
2307.9.MESS  
2307.9.INOX

build-in

# OUTDOOR | In-ground luminaires | LAVA



WO - op aanvraag wartelingang onderaan - sur demande presse-étoupe en bas - on request PG gland at the bottom - auf Anfrage PG Verschraubung unten

## 2325.230V.5/.. - LAVA

~230V IP66 0.5 m 05.10.02



floorlight  
Bodenleuchte

### Dimensions

L100xB100xH135

102x102 140

5mm glass - Glas

### Options

■ S1139.5/.. - SUPPLEMENT SQUARE GLASS

A Fixed	C Directional
led 230V . (1) 3,6W / 230V	led 230V . (1) 4W / 230V
2325.A.5.ALU	2325.C.5.ALU
2325.A.5.INOX	2325.C.5.INOX
2325.A.5.MESS	2325.C.5.MESS

build-in

## 2325.230V.9/.. - LAVA

~230V IP66 0.5 m 05.10.02



floorlight  
Bodenleuchte

### Dimensions

L100xB100xH135

102x102 140

9mm glass - Glas

### Options

■ S1139.9/.. - SUPPLEMENT SQUARE GLASS

A Fixed	C Directional
led 230V . (1) 3,6W / 230V	led 230V . (1) 4W / 230V
2325.A.9.ALU	2325.C.9.ALU
2325.A.9.INOX	2325.C.9.INOX
2325.A.9.MESS	2325.C.9.MESS

build-in

## 2325.24V.5/.. - LAVA

=24V-DC III IP66 0.5 m 05.10.02



floorlight - without LED driver  
Bodenleuchte - ohne Driver LED

### Dimensions

L100xB100xH135

102x102 140

5mm glass - Glas

### Options

■ S1139.5/.. - SUPPLEMENT SQUARE GLASS

B Fixed	D Directional
led 24V-DC . (1) 3,6W / 24V-DC	led 24V-DC . (1) 4W / 24V-DC
2325.B.5.ALU	2325.D.5.ALU
2325.B.5.INOX	2325.D.5.INOX
2325.B.5.MESS	2325.D.5.MESS

build-in  
parallel connection  
Parallelschaltung

## 2325.24V.9/.. - LAVA

=24V-DC III IP66 0.5 m 05.10.02



floorlight - without LED driver  
Bodenleuchte - ohne Driver LED

### Dimensions

L100xB100xH135

102x102 140

9mm glass - Glas

### Options

■ S1139.9/.. - SUPPLEMENT SQUARE GLASS

B Fixed	D Directional
led 24V-DC . (1) 3,6W / 24V-DC	led 24V-DC . (1) 4W / 24V-DC
2325.B.9.ALU	2325.D.9.ALU
2325.B.9.INOX	2325.D.9.INOX
2325.B.9.MESS	2325.D.9.MESS

build-in  
parallel connection  
Parallelschaltung

# OUTDOOR | In-ground luminaires | LAVA = even with the floor



WO - op aanvraag wartelingang onderaan - sur demande presse-étoupe en bas - on request PG gland at the bottom - auf Anfrage PG Verschraubung unten

## 2217.5/./.. - LAVA = even with the floor

~12V



build-in



floorlight with build-in frame even with the floor - without transformer  
Bodenleuchte mit Einbaurahmen gleich mit dem Boden - ohne Trafo

### Lamp type

QR-CB 51 GU5,3/GX5,3 (1) 50W 12V

### Dimensions

L104xB104xH135  
105x105 140  
5mm glass - Glas

### Options

■ S1139.5/.. - SUPPLEMENT SQUARE GLASS

Fixed	Directional
2217.5.ALU	2218.5.ALU
2217.5.INOX	2218.5.INOX
2217.5.MESS	2218.5.MESS

## 2217.9/./.. - LAVA = even with the floor

~12V



build-in



floorlight with build-in frame even with the floor - without transformer  
Bodenleuchte mit Einbaurahmen gleich mit dem Boden - ohne Trafo

### Lamp type

QR-CB 51 GU5,3/GX5,3 (1) 50W 12V

### Dimensions

L104xB104xH135  
105x105 140  
9mm glass - Glas

### Options

■ S1139.9/.. - SUPPLEMENT SQUARE GLASS

Fixed	Directional
2217.9.ALU	2218.9.ALU
2217.9.INOX	2218.9.INOX
2217.9.MESS	2218.9.MESS

## OUTDOOR | In-ground luminaires | LAVA = even with the floor



WO - op aanvraag wartelingang onderaan - sur demande presse-étoupe en bas - on request PG gland at the bottom - auf Anfrage PG Verschraubung unten

### 2219.5/.. - LAVA = even with the floor

~230V



build-in



floorlight with build-in frame even with the floor - 230V  
Bodenleuchte mit Einbaurahmen gleich mit dem Boden - 230V

#### Lamptype

QPAR 51 GU10 (1) 35W 230V  
or QPAR 51 GU10 (1) 11W 230V

#### Dimensions

L104xB104xH135  
105x105 140  
5mm glass - Glas

#### Options

■ S1139.5/.. - SUPPLEMENT SQUARE GLASS

#### Ref

2219.5.ALU  
2219.5.MESS  
2219.5.INOX

### 2219.9/.. - LAVA = even with the floor

~230V



build-in



floorlight with build-in frame even with the floor - 230V  
Bodenleuchte mit Einbaurahmen gleich mit dem Boden - 230V

#### Lamptype

QPAR 51 GU10 (1) 35W 230V  
or QPAR 51 GU10 (1) 11W 230V

#### Dimensions

L104xB104xH135  
105x105 140  
9mm glass - Glas

#### Options

■ S1139.9/.. - SUPPLEMENT SQUARE GLASS

#### Ref

2219.9.ALU  
2219.9.MESS  
2219.9.INOX

### 2317.5/.. - LAVA = even with the floor

~230V



build-in



floorlight with build-in frame even with the floor - microlynx  
Bodenleuchte mit Einbaurahmen gleich mit dem Boden - microlynx

#### Lamptype

TC-FSE GX53 (1) 9W 230V

#### Dimensions

L104xB104xH105  
105x105 110  
5mm glass - Glas

#### Options

■ S1139.5/.. - SUPPLEMENT SQUARE GLASS

#### Ref

2317.5.ALU  
2317.5.MESS  
2317.5.INOX

### 2317.9/.. - LAVA = even with the floor

~230V



build-in



floorlight with build-in frame even with the floor - microlynx  
Bodenleuchte mit Einbaurahmen gleich mit dem Boden - microlynx

#### Lamptype

TC-FSE GX53 (1) 9W 230V

#### Dimensions

L104xB104xH105  
105x105 110  
9mm glass - Glas

#### Options

■ S1139.9/.. - SUPPLEMENT SQUARE GLASS

#### Ref

2317.9.ALU  
2317.9.MESS  
2317.9.INOX

# OUTDOOR | In-ground luminaires | LAVA = even with the floor



WO - op aanvraag wartelingang onderaan - sur demande presse-étoupe en bas - on request PG gland at the bottom - auf Anfrage PG Verschraubung unten

## 2318.230V.5/.. - LAVA = even with the floor

~230V IP66 0.5 m 05.10.02



floorlight with build-in frame even with the floor  
Bodenleuchte mit Einbaurahmen gleich mit dem Boden

### Dimensions

- L104xB104xH135
- 105x105 140
- 5mm glass - Glas

### Options

- S1139.5/.. - SUPPLEMENT SQUARE GLASS

A Fixed	C Directional
led 230V . (1) 3,6W / 230V	led 230V . (1) 4W / 230V
2318.A.5.ALU	2318.C.5.ALU
2318.A.5.INOX	2318.C.5.INOX
2318.A.5.MESS	2318.C.5.MESS

build-in

## 2318.230V.9/.. - LAVA = even with the floor

~230V IP66 0.5 m 05.10.02



floorlight with build-in frame even with the floor  
Bodenleuchte mit Einbaurahmen gleich mit dem Boden

### Dimensions

- L104xB104xH135
- 105x105 140
- 9mm glass - Glas

### Options

- S1139.9/.. - SUPPLEMENT SQUARE GLASS

A Fixed	C Directional
led 230V . (1) 3,6W / 230V	led 230V . (1) 4W / 230V
2318.A.9.ALU	2318.C.9.ALU
2318.A.9.INOX	2318.C.9.INOX
2318.A.9.MESS	2318.C.9.MESS

build-in

## 2318.24V.5/.. - LAVA = even with the floor

=24V-DC III IP66 0.5 m 05.10.02



floorlight with build-in frame even with the floor - without LED driver  
Bodenleuchte mit Einbaurahmen gleich mit dem Boden - ohne Driver LED

### Dimensions

- L100xB100xH135
- 105x105 140
- 5mm glass - Glas

### Options

- S1139.5/.. - SUPPLEMENT SQUARE GLASS

B Fixed	D Directional
led 24V-DC . (1) 3,6W / 24V-DC	led 24V-DC . (1) 4W / 24V-DC
2318.B.5.ALU	2318.D.5.ALU
2318.B.5.INOX	2318.D.5.INOX
2318.B.5.MESS	2318.D.5.MESS

build-in  
parallel connection  
Parallelschaltung

## 2318.24V.9/.. - LAVA = even with the floor

=24V-DC III IP66 0.5 m 05.10.02



floorlight with build-in frame even with the floor - without LED driver  
Bodenleuchte mit Einbaurahmen gleich mit dem Boden - ohne Driver LED

### Dimensions

- L100xB100xH135
- 105x105 140
- 9mm glass - Glas

### Options

- S1139.9/.. - SUPPLEMENT SQUARE GLASS

B Fixed	D Directional
led 24V-DC . (1) 3,6W / 24V-DC	led 24V-DC . (1) 4W / 24V-DC
2318.B.9.ALU	2318.D.9.ALU
2318.B.9.INOX	2318.D.9.INOX
2318.B.9.MESS	2318.D.9.MESS

build-in  
parallel connection  
Parallelschaltung

In-ground luminaires outdoor

## OUTDOOR | In-ground luminaires | LAVA cover on the floor



WO - op aanvraag wartelingang onderaan - sur demande presse-étoupe en bas - on request PG gland at the bottom - auf Anfrage PG Verschraubung unten

### 2223.5/.. - LAVA cover on the floor

~12V



floorlight with cover plate on the floor - without transformer  
Bodenleuchte mit Abdeckplatte auf dem Boden - ohne Trafo

#### Lamp type

QR-CB 51 GU5,3/GX5,3 (1) 50W 12V

#### Dimensions

L130-L150xB130-B150xH135

Ø102 H 140

5mm glass - Glas

Fixed	Directional
2223.5.130.INOX	2224.5.130.INOX
2223.5.130.MESS	2224.5.130.MESS
2223.5.150.INOX	2224.5.150.INOX
2223.5.150.MESS	2224.5.150.MESS

build-in

### 2223.9/.. - LAVA cover on the floor

~12V



floorlight with cover plate on the floor - without transformer  
Bodenleuchte mit Abdeckplatte auf dem Boden - ohne Trafo

#### Lamp type

QR-CB 51 GU5,3/GX5,3 (1) 50W 12V

#### Dimensions

L130-L150xB130-B150xH135

Ø102 H 140

9mm glass - Glas

Fixed	Directional
2223.9.130.INOX	2224.9.130.INOX
2223.9.130.MESS	2224.9.130.MESS
2223.9.150.INOX	2224.9.150.INOX
2223.9.150.MESS	2224.9.150.MESS

build-in

### 2225.5.130/.. - LAVA cover on the floor

~230V



floorlight with cover plate on the floor - 230V  
Bodenleuchte mit Abdeckplatte auf dem Boden - 230V

#### Lamp type

QPAR 51 GU10 (1) 35W 230V

or QPAR 51 GU10 (1) 11W 230V

#### Dimensions

L130xB130xH135

Ø102 H 140

5mm glass - Glas

#### Ref

2225.5.130.MESS

2225.5.130.INOX

build-in



WO - op aanvraag wartelingang onderaan - sur demande presse-étoupe en bas - on request PG gland at the bottom - auf Anfrage PG Verschraubung unten

**2225.5.150/.. - LAVA cover on the floor**

~230V



floorlight with cover plate on the floor - 230V  
Bodenleuchte mit Abdeckplatte auf dem Boden - 230V

**Lamptype**

☞ QPAR 51 GU10 (1) 35W 230V  
or ☞ QPAR 51 GU10 (1) 11W 230V

**Dimensions**

↔ L150xB150xH135  
☞ Ø102 √L 140  
☞ 5mm glass - Glas

**Ref**

2225.5.150.MESS  
2225.5.150.INOX

build-in

**2225.9.130/.. - LAVA cover on the floor**

~230V



floorlight with cover plate on the floor - 230V  
Bodenleuchte mit Abdeckplatte auf dem Boden - 230V

**Lamptype**

☞ QPAR 51 GU10 (1) 35W 230V  
or ☞ QPAR 51 GU10 (1) 11W 230V

**Dimensions**

↔ L130xB130xH135  
☞ Ø102 √L 140  
☞ 9mm glass - Glas

**Ref**

2225.9.130.MESS  
2225.9.130.INOX

build-in

**2225.9.150/.. - LAVA cover on the floor**

~230V



floorlight with cover plate on the floor - 230V  
Bodenleuchte mit Abdeckplatte auf dem Boden - 230V

**Lamptype**

☞ QPAR 51 GU10 (1) 35W 230V  
or ☞ QPAR 51 GU10 (1) 11W 230V

**Dimensions**

↔ L150xB150xH135  
☞ Ø102 √L 140  
☞ 9mm glass - Glas

**Ref**

2225.9.150.MESS  
2225.9.150.INOX

build-in

**2313.5.130/.. - LAVA cover on the floor**

~230V



floorlight with cover plate on the floor - microlynx  
Bodenleuchte mit Abdeckplatte auf dem Boden - microlynx

**Lamptype**

☞ TC-FSE GX53 (1) 9W 230V

**Dimensions**

↔ L130xB130xH105  
☞ Ø102 √L 110  
☞ 5mm glass - Glas

**Ref**

2313.5.130.MESS  
2313.5.130.INOX

build-in

## OUTDOOR | In-ground luminaires | LAVA cover on the floor



WO - op aanvraag wartelingang onderaan - sur demande presse-étoupe en bas - on request PG gland at the bottom - auf Anfrage PG Verschraubung unten

### 2313.5.150/.. - LAVA cover on the floor

~230V



IP66



0,8475

0,5 m



05.10.02



floorlight with cover plate on the floor - microlynx  
Bodenleuchte mit Abdeckplatte auf dem Boden - microlynx

#### Lamptype

⌀ TC-FSE GX53 (1) 9W 230V

#### Dimensions

↔ L150xB150xH105

📏 Ø102 √ 110

🔍 5mm glass - Glas

#### Ref

2313.5.150.MESS

2313.5.150.INOX

build-in

### 2313.9.130/.. - LAVA cover on the floor

~230V



IP66



0,8475

0,5 m



05.10.02



floorlight with cover plate on the floor - microlynx  
Bodenleuchte mit Abdeckplatte auf dem Boden - microlynx

#### Lamptype

⌀ TC-FSE GX53 (1) 9W 230V

#### Dimensions

↔ L130xB130xH105

📏 Ø102 √ 110

🔍 9mm glass - Glas

#### Ref

2313.9.130.MESS

2313.9.130.INOX

build-in

### 2313.9.150/.. - LAVA cover on the floor

~230V



IP66



0,9000

0,5 m



05.10.02



floorlight with cover plate on the floor - microlynx  
Bodenleuchte mit Abdeckplatte auf dem Boden - microlynx

#### Lamptype

⌀ TC-FSE GX53 (1) 9W 230V

#### Dimensions

↔ L150xB150xH105

📏 Ø102 √ 110

🔍 9mm glass - Glas

#### Ref

2313.9.150.MESS

2313.9.150.INOX

build-in





WO - op aanvraag wartelingang onderaan - sur demande presse-étoupe en bas - on request PG gland at the bottom - auf Anfrage PG Verschraubung unten

**2324.230V.5/.. - LAVA cover on the floor**

~230V IP66 0.5 m 05.10.02



build-in

floorlight with cover plate on the floor  
Bodenleuchte mit Abdeckplatte auf dem Boden

**Dimensions**

L130-L150xB130-B150xH135

Ø102 H 140

5mm glass - Glas

A Fixed	C Directional
led 230V . (1) 3,6W / 230V	led 230V . (1) 4W / 230V
2324.130.A.5.INOX	2324.130.C.5.INOX
2324.130.A.5.MESS	2324.130.C.5.MESS
2324.150.A.5.INOX	2324.150.C.5.INOX
2324.150.A.5.MESS	2324.150.C.5.MESS

**2324.230V.9/.. - LAVA cover on the floor**

~230V IP66 0.5 m 05.10.02



build-in

floorlight with cover plate on the floor  
Bodenleuchte mit Abdeckplatte auf dem Boden

**Dimensions**

L130-L150xB130-B150xH135

Ø102 H 140

9mm glass - Glas

A Fixed	C Directional
led 230V . (1) 3,6W / 230V	led 230V . (1) 4W / 230V
2324.130.A.9.INOX	2324.130.C.9.INOX
2324.130.A.9.MESS	2324.130.C.9.MESS
2324.150.A.9.INOX	2324.150.C.9.INOX
2324.150.A.9.MESS	2324.150.C.9.MESS

## OUTDOOR | In-ground luminaires | LAVA cover on the floor



WO - op aanvraag wartelingang onderaan - sur demande presse-étoupe en bas - on request PG gland at the bottom - auf Anfrage PG Verschraubung unten

### 2324.24V.5/.. - LAVA cover on the floor

=24V-DC



IP66



0.5 m



05.10.02



floorlight with cover plate on the floor - without LED driver  
Bodenleuchte mit Abdeckplatte auf dem Boden - ohne Driver LED

#### Dimensions

↔ L130-L150xB130-B150xH135

📏 Ø102    ↙ ↘ 140

🔩 5mm glass - Glas

B Fixed	D Directional
led 24V-DC . (1) 3,6W / 24V-DC	led 24V-DC . (1) 4W / 24V-DC
2324.130.B.5.INOX	2324.130.D.5.INOX
2324.130.B.5.MESS	2324.130.D.5.MESS
2324.150.B.5.INOX	2324.150.D.5.INOX
2324.150.B.5.MESS	2324.150.D.5.MESS

**build-in**  
parallel connection  
Parallelschaltung

### 2324.24V.9/.. - LAVA cover on the floor

=24V-DC



IP66



0.5 m



05.10.02



floorlight with cover plate on the floor - without LED driver  
Bodenleuchte mit Abdeckplatte auf dem Boden - ohne Driver LED

#### Dimensions

↔ L130-L150xB130-B150xH135

📏 Ø102    ↙ ↘ 140

🔩 9mm glass - Glas

B Fixed	D Directional
led 24V-DC . (1) 3,6W / 24V-DC	led 24V-DC . (1) 4W / 24V-DC
2324.130.B.9.INOX	2324.130.D.9.INOX
2324.130.B.9.MESS	2324.130.D.9.MESS
2324.150.B.9.INOX	2324.150.D.9.INOX
2324.150.B.9.MESS	2324.150.D.9.MESS

**build-in**  
parallel connection  
Parallelschaltung

2211.5./.. - ETNA

~230V   IP66   0,5 m  05.10.02 



floorlight - with transformer  
Bodenleuchte - mit Trafo

**Lamp type**

◁ QR-CB 51 GU5,3/GX5,3 (1) 50W 12V

**Dimensions**

↔ L240xB125xH135

∩ 140

⚡ 5mm glass - Glas

**Options**

■ S1139.5./.. - SUPPLEMENT SQUARE GLASS

build-in

Fixed	Directional
2211.5.ALU	2212.5.ALU
2211.5.INOX	2212.5.INOX
2211.5.MESS	2212.5.MESS

2211.9./.. - ETNA

~230V   IP66   0,5 m  05.10.02 



floorlight - with transformer  
Bodenleuchte - mit Trafo

**Lamp type**

◁ QR-CB 51 GU5,3/GX5,3 (1) 50W 12V

**Dimensions**

↔ L240xB125xH135

∩ 140

⚡ 9mm glass - Glas

**Options**

■ S1139.9./.. - SUPPLEMENT SQUARE GLASS

build-in

Fixed	Directional
2211.9.ALU	2212.9.ALU
2211.9.INOX	2212.9.INOX
2211.9.MESS	2212.9.MESS

In-ground luminaires outdoor

2247.5./.. - ETNA = even with the floor

~230V

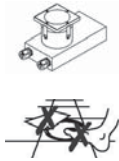

floorlight with build-in frame even with the floor - with transformer  
 Bodenleuchte mit Einbaurahmen gleich mit dem Boden - mit Trafo

**Lamptype**

◁ QR-CB 51 GU5,3/GX5,3 (1) 50W 12V

**Dimensions**

↔ L240xB125xH135

∩ 140

☼ 5mm glass - Glas

**Options**

■ S1139.5./.. - SUPPLEMENT SQUARE GLASS

build-in

Fixed	Directional
2247.5.ALU	2248.5.ALU
2247.5.INOX	2248.5.INOX
2247.5.MESS	2248.5.MESS

2247.9./.. - ETNA = even with the floor

~230V



floorlight with build-in frame even with the floor - with transformer  
 Bodenleuchte mit Einbaurahmen gleich mit dem Boden - mit Trafo

**Lamptype**

◁ QR-CB 51 GU5,3/GX5,3 (1) 50W 12V

**Dimensions**

↔ L240xB125xH135

∩ 140

☼ 9mm glass - Glas

**Options**

■ S1139.9./.. - SUPPLEMENT SQUARE GLASS

build-in

Fixed	Directional
2247.9.ALU	2248.9.ALU
2247.9.INOX	2248.9.INOX
2247.9.MESS	2248.9.MESS



WO - op aanvraag wartelingang onderaan - sur demande presse-étoupe en bas - on request PG gland at the bottom - auf Anfrage PG Verschraubung unten

2302.5./.. - ETNA

~230V



build-in



floorlight - with transformer  
Bodenleuchte - mit Trafo

Lamp type

QR-CB 51 GU5,3/GX5,3 (1) 50W 12V

Dimensions

L100xB100xH200

102x102 205

5mm glass - Glas

Options

S1139.5./.. - SUPPLEMENT SQUARE GLASS

Fixed	Directional
2302.5.ALU	2303.5.ALU
2302.5.INOX	2303.5.INOX
2302.5.MESS	2303.5.MESS

2302.9./.. - ETNA

~230V



build-in



floorlight - with transformer  
Bodenleuchte - mit Trafo

Lamp type

QR-CB 51 GU5,3/GX5,3 (1) 50W 12V

Dimensions

L100xB100xH200

102x102 205

9mm glass - Glas

Options

S1139.9./.. - SUPPLEMENT SQUARE GLASS

Fixed	Directional
2302.9.ALU	2303.9.ALU
2302.9.INOX	2303.9.INOX
2302.9.MESS	2303.9.MESS

## OUTDOOR | In-ground luminaires | ETNA = even with the floor



WO - op aanvraag wartelingang onderaan - sur demande presse-étoupe en bas - on request PG gland at the bottom - auf Anfrage PG Verschraubung unten

### 2347.5./.. - ETNA = even with the floor

~230V



build-in



floorlight with build-in frame even with the floor - with transformer  
Bodenleuchte mit Einbaurahmen gleich mit dem Boden - mit Trafo

#### Lamp type

QR-CB 51 GU5,3/GX5,3 (1) 50W 12V

#### Dimensions

L103xB103xH200

105x105

5mm glass - Glas

#### Options

■ S1139.5./.. - SUPPLEMENT SQUARE GLASS

Fixed	Directional
2347.5.ALU	2348.5.ALU
2347.5.INOX	2348.5.INOX
2347.5.MESS	2348.5.MESS

### 2347.9./.. - ETNA = even with the floor

~230V



build-in



floorlight with build-in frame even with the floor - with transformer  
Bodenleuchte mit Einbaurahmen gleich mit dem Boden - mit Trafo

#### Lamp type

QR-CB 51 GU5,3/GX5,3 (1) 50W 12V

#### Dimensions

L103xB103xH200

105x105 205

9mm glass - Glas

#### Options

■ S1139.9./.. - SUPPLEMENT SQUARE GLASS

Fixed	Directional
2347.9.ALU	2348.9.ALU
2347.9.INOX	2348.9.INOX
2347.9.MESS	2348.9.MESS

# OUTDOOR | In-ground luminaires | ETNA cover on the floor



WO - op aanvraag wartelingang onderaan - sur demande presse-étoupe en bas - on request PG gland at the bottom - auf Anfrage PG Verschraubung unten

## 2257.5/./.. - ETNA cover on the floor

~230V

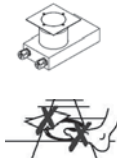

floorlight with cover plate on the floor - with transformer  
Bodenleuchte mit Abdeckplatte auf dem Boden - mit Trafo

### Lamptype

QR-CB 51 GU5,3/GX5,3 (1) 50W 12V

### Dimensions

L240xB125xH135

140

5mm glass - Glas

build-in

Fixed	Directional
2257.5.130.INOX	2258.5.130.INOX
2257.5.130.MESS	2258.5.130.MESS
2257.5.150.INOX	2258.5.150.INOX
2257.5.150.MESS	2258.5.150.MESS

## 2257.9/./.. - ETNA cover on the floor

~230V



floorlight with cover plate on the floor - with transformer  
Bodenleuchte mit Abdeckplatte auf dem Boden - mit Trafo

### Lamptype

QR-CB 51 GU5,3/GX5,3 (1) 50W 12V

### Dimensions

L240xB125xH135

140

9mm glass - Glas

build-in

Fixed	Directional
2257.9.130.INOX	2258.9.130.INOX
2257.9.130.MESS	2258.9.130.MESS
2257.9.150.INOX	2258.9.150.INOX
2257.9.150.MESS	2258.9.150.MESS

## 2357.5/./.. - ETNA cover on the floor

~230V



floorlight with cover plate on the floor - with transformer  
Bodenleuchte mit Abdeckplatte auf dem Boden - mit Trafo

### Lamptype

QR-CB 51 GU5,3/GX5,3 (1) 50W 12V

### Dimensions

L130-L150xB130-B150xH200

Ø102 205

5mm glass - Glas

build-in

Fixed	Directional
2357.5.130.INOX	2358.5.130.INOX
2357.5.130.MESS	2358.5.130.MESS
2357.5.150.INOX	2358.5.150.INOX
2357.5.150.MESS	2358.5.150.MESS

## OUTDOOR | In-ground luminaires | ETNA cover on the floor | LAVA - ETNA



WO - op aanvraag wartelingang onderaan - sur demande presse-étoupe en bas - on request PG gland at the bottom - auf Anfrage PG Verschraubung unten

### 2357.9/./../ - ETNA cover on the floor

~230V



IP66



floorlight with cover plate on the floor - with transformer  
Bodenleuchte mit Abdeckplatte auf dem Boden - mit Trafo

#### Lamp type

QR-CB 51 GU5,3/GX5,3 (1) 50W 12V

#### Dimensions

L130-L150xB130-B150xH200

Ø102 205

9mm glass - Glas

Fixed	Directional
2357.9.130.INOX	2358.9.130.INOX
2357.9.130.MESS	2358.9.130.MESS
2357.9.150.INOX	2358.9.150.INOX
2357.9.150.MESS	2358.9.150.MESS

build-in

### INSTALLATION PG GLAND - MONTAGE KRIMP GAINÉ - MONTAGE DE LA GAINÉ THERMORETRACTABLE - MONTAGE PG KABELVERSCHRÄUBUNG



2 heat shrinks are enclosed with every well light. - Bij elke grondspot worden standaard 2 krimpgaines bijgeleverd. - 2 gaines thermorétractables sont livrées avec chaque spot à encasturer dans le sol. - 2 Schrumpfschläuche sind bei jeder einbau Bodenleuchte mitgeliefert.

Tighten the seal ring PG gland until the cable is secure around. Slide the heat shrink tube over the PG gland up to the housing. Heat the heat shrink tube carefully with the help of a drier. Heat until it fits perfectly around the PG gland.

Dichtingsring wartel aanspannen zodat de kabel goed vastzit. Krimpgaine over de wartel schuiven tot aan het lichaam van de grondspot. Krimpgaine met warmeluchtblazer lichtjes opwarmen tot krimpgaine zich rond de kabel en mof zet.

Serrez le câble dans le presse-étoupe en vissant l'écrou d'étanchéité. Glissez la gaine thermorétractable par-dessus le presse-étoupe jusqu'au boîtier. Chauffez prudemment la gaine thermorétractable à l'aide d'un pistolet à chaleur jusqu'à ce qu'il épouse parfaitement l'ensemble.

Abdichtungsring der Kabelschraubung anspannen bis das Kabel gefestigt ist. Den Schrumpfschlauch über das Kabel und die PG Verschraubung bis an die Bodenleuchte schieben. Den Schrumpfschlauch erwärmen, bis er sich um das Kabel und die PG Verschraubung geformt hat.

### CLEANING - ONDERHOUD - NETTOYAGE - REINIGUNG

Do not spray any pesticides on to the devices, nor clean with solvent bases cleaning products.

Niet besproeien met pesticiden noch andere tuinsproeistoffen. Niet reinigen met producten op basis van solventen of detergenten.

Ne pas arroser l'appareil avec des produits chimiques tels que pesticides, herbicides, etc. Ne pas nettoyer avec solvants ou détergents.

Die Leuchten nicht bespritzen mit Pestiziden. Nicht sauber machen mit Solvente oder Detergente.



Niet afdekken met brandbare voorwerpen - Niet met blote voeten op grondspot lopen

Ne pas couvrir avec des objets inflammables - Ne marchez pas pieds nus sur le spot de sol

Do not cover with flammable objects - Do not walk on the ground light with bare feet

Nicht mit entzündlichen Objekten abdecken - Nicht mit nackten Füßen auf Bodenleuchte laufen



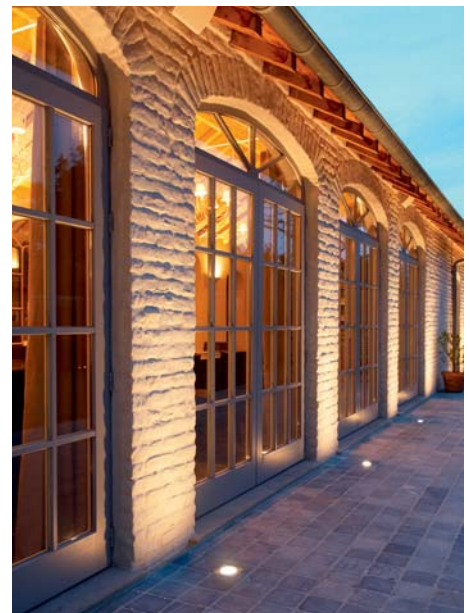

### 1135.5/.. - LAVA - ETNA

IP20    0,2167 



accessories for floorlight - cover plate  
Zubehör für Bodenleuchte - Abdeckplatte

#### Dimensions

→ Ø100xH10

🌀 5mm glass - Glas

#### Ref

1135.5.ALU

1135.5.MESS

1135.5.INOX

### 1135.9/.. - LAVA - ETNA

IP20    0,2867 



accessories for floorlight - cover plate  
Zubehör für Bodenleuchte - Abdeckplatte

#### Dimensions

→ Ø100xH14

🌀 9mm glass - Glas

#### Ref

1135.9.ALU

1135.9.MESS

1135.9.INOX

### 1143/.. - LAVA - ETNA

IP20    0,3500 



accessories for floorlight - top with rotationally symmetric  
light output

Zubehör für Bodenleuchte - Kopf mit  
rotationssymmetrischem Lichtaustritt

#### Dimensions

→ Ø100xH55

#### Ref

1143.ALU

1143.MESS

1143.INOX

1145/.. - LAVA - ETNA

IP20   0,8817 



accessories for floorlight - top with rotationally symmetric light output  
Zubehör für Bodenleuchte - Kopf mit rotationssymmetrischem Lichtaustritt

**Dimensions**

↔ Ø100xH110

**Ref**

1145.ALU  
1145.MESS  
1145.INOX

2308.5/.. - LAVA - ETNA

~230V  IP20   0,8600 



accessories for floorlight - stainless steel cover with single-sided light output  
Zubehör für Bodenleuchte - Kopf in Edelstahl mit einseitigem Lichtaustritt

**Dimensions**

↔ Ø100xH27

**Ref**

2308.5.INOX

1136.5/.. - LAVA - ETNA

IP20   0,3717 



accessories for floorlight - cover plate  
Zubehör für Bodenleuchte - Abdeckplatte

**Dimensions**

↔ L100xB100xH10

☞ 5mm glass - Glas

**Ref**

1136.5.ALU  
1136.5.MESS  
1136.5.INOX

1136.9/.. - LAVA - ETNA

IP20   0,5650 



accessories for floorlight - cover plate  
Zubehör für Bodenleuchte - Abdeckplatte

**Dimensions**

↔ L100xB100xH14

☞ 9mm glass - Glas

**Ref**

1136.9.ALU  
1136.9.MESS  
1136.9.INOX

1138.5/.. - LAVA - ETNA

IP20   0,4750 

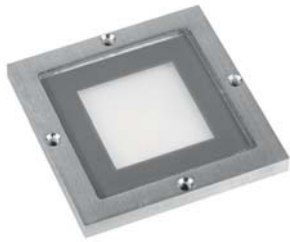

accessories for floorlight - cover plate  
Zubehör für Bodenleuchte - Abdeckplatte

**Dimensions**

↔ L100xB100xH10

⚡ 5mm glass - Glas

**Ref**

1138.5.ALU

1138.5.MESS

1138.5.INOX

1138.9/.. - LAVA - ETNA

IP20   0,5783 

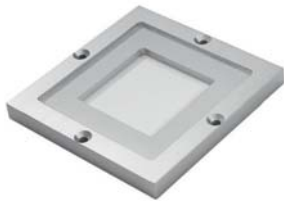

accessories for floorlight - cover plate  
Zubehör für Bodenleuchte - Abdeckplatte

**Dimensions**

↔ L100xB100xH14

⚡ 9mm glass - Glas

**Ref**

1138.9.ALU

1138.9.MESS

1138.9.INOX

S1139.5/.. - SUPPLEMENT SQUARE GLASS

IP20   1,9087 

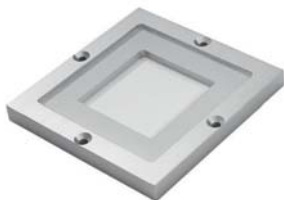

supplement for floorlight - square cover plate with square glass - must be ordered together with floorlight!  
Supplement für Bodenleuchte - viereckige Abdeckplatte mit viereckigem Glas - muss zusammen mit Bodenleuchte bestellt werden!

⚡ 5mm glass - Glas

**Ref**

S1139.5.ALU

S1139.5.MESS

S1139.5.INOX

S1139.9/.. - SUPPLEMENT SQUARE GLASS

IP20  

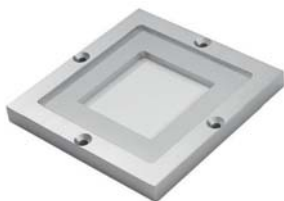

supplement for floorlight - square cover plate with square glass - must be ordered together with floorlight!  
Supplement für Bodenleuchte - viereckige Abdeckplatte mit viereckigem Glas - muss zusammen mit Bodenleuchte bestellt werden!

⚡ 9mm glass - Glas

**Ref**

S1139.9.ALU

S1139.9.MESS

S1139.9.INOX

1115.100.5/.. - LAVA - ETNA

IP20   0,1450 



accessories for floorlight - build-in frame 100x100 for glass 5mm  
Zubehör für Bodenleuchte - Einbaurahmen 100x100 für Glas 5mm

Ref

1115.100.5

Dimensions

↔ L100xB100

1115.100.9/.. - LAVA - ETNA

IP20   0,1650 



accessories for floorlight - build-in frame 100x100 for glass 9mm  
Zubehör für Bodenleuchte - Einbaurahmen 100x100 für Glas 9mm

Ref

1115.100.9

Dimensions

↔ L100xB100

00GLAS5MM/.. - LAVA - ETNA

IP20   0,0550 



spare glass - round mat glass 5mm for 1135-1136  
Ersatzglas - rundes mattes Glas 5mm für 1135-1136  
⌀ 5mm glass - Glas

Ref

00GLAS5MM

00GLAS9MM/.. - LAVA - ETNA

IP20   0,0950 



spare glass - round mat glass 9mm for 1135-1136  
Ersatzglas - rundes mattes Glas 9mm für 1135-1136  
⌀ 9mm glass - Glas

Ref

00GLAS9MM

00HERSTGLAS5MM/.. - LAVA - ETNA

IP20   



spare glass + repair - glue new glass in cover plate  
Ersatzglas + Reparatur - neues Glas in Abdeckplatte einleimen

 5mm glass - Glas

Ref

00HERSTGLAS5MM

00HERSTGLAS9MM/.. - LAVA - ETNA

IP20   



spare glass + repair - glue new glass in cover plate  
Ersatzglas + Reparatur - neues Glas in Abdeckplatte einleimen

 9mm glass - Glas

Ref

00HERSTGLAS9MM

00GLAS5MMSQ/.. - LAVA - ETNA

IP20    0,0650 



spare glass - square mat glass 5mm for 1138 - S1139  
Ersatzglas - viereckiges mattes Glas 5mm für 1138 - S1139

 5mm glass - Glas

Ref

00GLAS5MMSQ

00GLAS9MMSQ/.. - LAVA - ETNA

IP20    0,1200 



spare glass - square mat glass 9mm for 1138 - S1139  
Ersatzglas - viereckiges mattes Glas 9mm für 1138 - S1139

 9mm glass - Glas

Ref

00GLAS9MMSQ

00HERSTGLAS5MMSQ/.. - LAVA - ETNA

IP20   



spare glass + repair - glue new glass in cover plate  
Ersatzglas + Reparatur - neues Glas in Abdeckplatte einleimen  
☞ 5mm glass - Glas

Ref  
00HERSTGLAS5MMSQ

00HERSTGLAS9MMSQ/.. - LAVA - ETNA

IP20   



spare glass + repair - glue new glass in cover plate  
Ersatzglas + Reparatur - neues Glas in Abdeckplatte einleimen  
☞ 9mm glass - Glas

Ref  
00HERSTGLAS9MMSQ

1150/.. - LAVA - ETNA

IP20   0,0050 



accessories for floorlight  
Zubehör für Bodenleuchte

Ref  
1150

1150MICROLYNX/.. - LAVA - ETNA

IP20   0,0050 



accessories for floorlight - sealing ring for microlynx spot  
Zubehör für Bodenleuchte - Dichtungsring für microlynx Leuchte

Ref  
1150MICROLYNX

1115.135.5/.. - LAVA - ETNA

IP20    0,2300 



accessories for floorlight - build-in frame 135x135 for glass 5mm  
Zubehör für Bodenleuchte - Einbaurahmen 135x135 für Glas 5mm

Ref  
1115.135.5

Dimensions

↔ L135xB135

1115.135.9/.. - LAVA - ETNA

IP20    0,2650 



accessories for floorlight - build-in frame 135x135 for glass 9mm  
Zubehör für Bodenleuchte - Einbaurahmen 135x135 für Glas 9mm

Ref  
1115.135.9

Dimensions

↔ L135xB135

1134/.. - LAVA - ETNA

IP20    1,6500 



accessories for floorlight - build-in housing  
Zubehör für Bodenleuchte - Einbaugehäuse

Ref  
1134

Options

- 1136.5.135/.. - LAVA - ETNA
- 1138.5.135/.. - LAVA - ETNA

only to order with 1136.5.135 and 1138.5.135  
nur bestellen mit 1136.5.135 oder 1138.5.135

1136.5.135/.. - LAVA - ETNA

IP20    0,7875 



accessories for floorlight - cover plate  
Zubehör für Bodenleuchte - Abdeckplatte

Ref  
1136.5.135.ALU  
1136.5.135.INOX

Dimensions

↔ L135xB135xH10

⊘ 5mm glass - Glas

1136.9.135/.. - LAVA - ETNA

IP20   1,1850 



accessories for floorlight - cover plate  
Zubehör für Bodenleuchte - Abdeckplatte

**Ref**

1136.9.135.ALU

1136.9.135.INOX

**Dimensions**

↔ L135xB135xH14

⊕ 9mm glass - Glas

S1136.5.135/.. - SUPPLEMENT LARGER COVER PLATE

IP20   0,5625 



supplement for floorlight - square cover plate with round glass - must be ordered together with floorlight!  
Supplement für Bodenleuchte - viereckige Abdeckplatte mit rundem Glas - muss zusammen mit Bodenleuchte bestellt werden!

**Ref**

S1136.5.135.ALU

S1136.5.135.INOX

**Dimensions**

↔ L135xB135

⊕ 5mm glass - Glas

S1136.9.135/.. - SUPPLEMENT LARGER COVER PLATE

IP20  



supplement for floorlight - square cover plate with round glass - must be ordered together with floorlight!  
Supplement für Bodenleuchte - viereckige Abdeckplatte mit rundem Glas - muss zusammen mit Bodenleuchte bestellt werden!

**Ref**

S1136.9.135.ALU

S1136.9.135.INOX

**Dimensions**

↔ L135xB135

⊕ 9mm glass - Glas

1138.5.135/.. - LAVA - ETNA

IP20   0,7875 

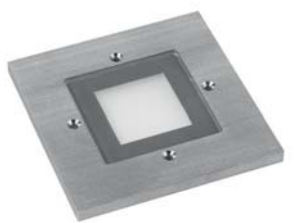

accessories for floorlight - cover plate  
Zubehör für Bodenleuchte - Abdeckplatte

**Ref**

1138.5.135.ALU

1138.5.135.INOX

**Dimensions**

↔ L135xB135xH10

⊕ 5mm glass - Glas



1138.9.135/.. - LAVA - ETNA

IP20   1,1875 



accessories for floorlight - cover plate  
Zubehör für Bodenleuchte - Abdeckplatte

Ref

1138.9.135.ALU

1138.9.135.INOX

Dimensions

↔ L135xB135xH14

🌀 9mm glass - Glas

S1138.5.135/.. - SUPPLEMENT LARGER COVER PLATE

IP20   5,6875 



supplement for floorlight - square cover plate with square glass - must be ordered together with floorlight!  
Supplement für Bodenleuchte - viereckige Abdeckplatte mit viereckigem Glas - muss zusammen mit Bodenleuchte bestellt werden!

Ref

S1138.5.135.ALU

S1138.5.135.INOX

Dimensions

↔ L135xB135

🌀 5mm glass - Glas

S1138.9.135/.. - SUPPLEMENT LARGER COVER PLATE

IP20   



supplement for floorlight - square cover plate with square glass - must be ordered together with floorlight!  
Supplement für Bodenleuchte - viereckige Abdeckplatte mit viereckigem Glas - muss zusammen mit Bodenleuchte bestellt werden!

Ref

S1138.9.135.ALU

S1138.9.135.INOX

Dimensions

↔ L135xB135

🌀 9mm glass - Glas

2304.12V/.. - LAVA - ETNA

~12V   IP66   0,5 m  



accessories for floorlight - without transformer  
Zubehör für Bodenleuchte - ohne Trafo

Ref

2304.12V

Lamp type

⊂ QR-CB 51 GU5,3/GX5,3 (1) 50W

12V

2304.230V/.. - LAVA - ETNA

~230V  IP66   1 m  05.10.02 



accessories for floorlight  
Zubehör für Bodenleuchte

Ref  
2304.230V

**Lamptype**

 QPAR 51 GU10 (1) 35W 230V

WO/.. - WO

IP20   0,0100 



supplement - PG gland at the bottom  
Supplement - PG Verschraubung unten

Ref

e.g. 2200/5/inox/WO for luminaire with PG gland at the bottom  
z.B. 2200/5/inox/WO für Leuchte mit PG Verschraubung unten

1114/.. - LAVA - ETNA

IP20   0,0200 



accessories for floorlight - cooling ring  
Zubehör für Bodenleuchte - Kühlungsring

Ref  
1114

1114GL/.. - LAVA - ETNA

IP20   0,0200 



accessories for floorlight - glass for cooling ring  
Zubehör für Bodenleuchte - Glas für Kühlungsring

Ref  
1114GL

L1/.. - LAVA - ETNA

IP20  

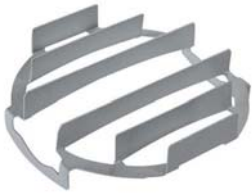

accessories for floorlight - louvre  
Zubehör für Bodenleuchte - Gitter

Ref  
L1

L2/.. - LAVA - ETNA

IP20  



accessories for floorlight - honeycomb louvre  
Zubehör für Bodenleuchte - Honigwabe

Ref  
L2

1137.5/.. - LAVA - ETNA

IP20    0,2633 



accessories for floorlight - cover plate with border  
Zubehör für Bodenleuchte - Abdeckplatte mit Rand

Dimensions

↔ Ø100xH10

⊘ 5mm glass - Glas

Ref  
1137.5.ALU  
1137.5.MESS  
1137.5.INOX

1137.9/.. - LAVA - ETNA

IP20    0,3417 



accessories for floorlight - cover plate with border  
Zubehör für Bodenleuchte - Abdeckplatte mit Rand

Dimensions

↔ Ø100xH14

⊘ 9mm glass - Glas

Ref  
1137.9.ALU  
1137.9.MESS  
1137.9.INOX

1129.180/.. - LAVA - ETNA

IP20   0,2400 



accessories for floorlight - cover plate  
Zubehör für Bodenleuchte - Abdeckplatte

**Dimensions**

↔ Ø180xH2

**Ref**

1129.180.MESS

1129.180.INOX

1141.160/.. - LAVA - ETNA

IP20   0,2350 



accessories for floorlight - cover plate  
Zubehör für Bodenleuchte - Abdeckplatte

**Dimensions**

↔ Ø160xH2

**Ref**

1141.160.MESS

1141.160.INOX

1149.130/.. - LAVA - ETNA

IP20   0,1225 



accessories for floorlight - cover plate  
Zubehör für Bodenleuchte - Abdeckplatte

**Dimensions**



↔ Ø130xH2

**Ref**

1149.130.MESS

1149.130.INOX

1130.150/.. - LAVA - ETNA

IP20   0,3000 

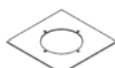

accessories for floorlight - cover plate  
Zubehör für Bodenleuchte - Abdeckplatte

**Dimensions**

↔ L150xB150xH2

**Ref**

1130.150.MESS

1130.150.INOX

1142.130/.. - LAVA - ETNA

IP20   0,1850 



accessories for floorlight - cover plate  
Zubehör für Bodenleuchte - Abdeckplatte

Ref  
1142.130.MESS  
1142.130.INOX

Dimensions  
↔ L130xB130xH2

2360.9/.. - LAVA GRANDE



~12V   IP66   4,0050  1 m  



floorlight - directional - without transformer  
Bodenleuchte - schwenkbar - ohne Trafo

Ref  
2360.9.INOX

Lamp type  
⦿ QR-LP111 G53 (1) 100W 12V  
or ⦿ QR-LP111 G53 (1) 50W 12V

Dimensions  
↔ Ø180xH150  
 Ø182  150  
 9mm glass - Glas

build-in

2361.9/.. - LAVA GRANDE



~230V  IP66   4,2890  1 m  



floorlight - directional  
Bodenleuchte - schwenkbar

Ref  
2361.9.INOX

Lamp type  
⦿ QPAR 111 GU10 (1) 75W 230V

Dimensions  
↔ Ø180xH150  
 Ø182  150  
 9mm glass - Glas

build-in

2363.9/.. - LAVA GRANDE





~230V  IP66   1 m  



floorlight - fixed  
Bodenleuchte - fest

Ref  
2363.9.INOX

Lamp type  
⦿ TC-HSE E27 (1) 20W 230V

Dimensions  
↔ Ø180xH235  40° reflector  
 Ø182  235  
 9mm glass - Glas

build-in

2364.9/.. - LAVA GRANDE cover on the floor

~12V        







floorlight with cover plate on the floor - directional - without transformer  
Bodenleuchte mit Abdeckplatte auf dem Boden - schwenkbar - ohne Trafo

Ref  
2364.9.INOX

Lamptype

 QR-LP111 G53 (1) 100W 12V  
or  QR-LP111 G53 (1) 50W 12V

Dimensions

 Ø250xH150  
 Ø155  150  
 9mm glass - Glas

build-in

2365.9/.. - LAVA GRANDE cover on the floor

~230V  IP66      







floorlight with cover plate on the floor - directional  
Bodenleuchte mit Abdeckplatte auf dem Boden - schwenkbar

Ref  
2365.9.INOX

Lamptype

 QPAR 111 GU10 (1) 75W 230V

Dimensions

 Ø250xH150  
 Ø155  150  
 9mm glass - Glas

build-in

2367.9/.. - LAVA GRANDE cover on the floor

~230V  IP66     







floorlight with cover plate on the floor - fixed  
Bodenleuchte mit Abdeckplatte auf dem Boden - fest

Ref  
2367.9.INOX

Lamptype

 TC-HSE E27 (1) 20W 230V

Dimensions

 Ø250xH235  40° reflector  
 Ø155  235  
 9mm glass - Glas

build-in

2368.9/.. - LAVA GRANDE

~230V   IP66       







floorlight - directional - with transformer  
Bodenleuchte - schwenkbar - mit Trafo

Ref  
2368.9.INOX

Lamptype

 QR-LP111 G53 (1) 75W 12V  
or  QR-LP111 G53 (1) 50W 12V

Dimensions

 Ø180xH320  
 Ø182  320  
 9mm glass - Glas

build-in  
105VA

OUTDOOR | In-ground luminaires | LAVA GRANDE | LAVA GRANDE cover on the floor

2369.9/.. - LAVA GRANDE

~230V  IP66   0,5 m  05.10.50 



floorlight  
Bodenleuchte

Ref

2369.9.INOX

Lamp type

TC-TSE E27Ls (1) 23W 230V

Dimensions

Ø180xH320  40° reflector

Ø182  320

 9mm glass - Glas

build-in  
other °angle reflector on demand  
andere °Winkel Reflektor auf Anfrage

2370.9/.. - LAVA GRANDE

~230V  IP66   1 m  05.10.50 



floorlight - fixed - with magnetic gear  
Bodenleuchte - fest - mit magnetischem Vorschaltgerät

Ref

2370.9.INOX

Lamp type

HIT-CE G12 (1) 35W 230V

Dimensions

Ø180xH320  30° reflector

Ø182  320

 9mm glass - Glas

build-in  
70W on request - other °angle reflector on demand  
70W auf Anfrage - andere °Winkel Reflektor auf Anfrage

2371.9/.. - LAVA GRANDE

~230V  IP66   1 m  05.10.50 



floorlight - directional - with magnetic gear  
Bodenleuchte - schwenkbar - mit magnetischem Vorschaltgerät

Ref

2371.9.INOX

Lamp type

HIR-CE111 GX8,5 (1) 35W 230V

Dimensions

Ø180xH320

Ø182  320

 9mm glass - Glas

build-in  
70W on request  
70W auf Anfrage

2374.9/.. - LAVA GRANDE cover on the floor

~230V  IP66   5,4000  1 m  05.10.02 



floorlight with cover plate on the floor - directional - with transformer  
Bodenleuchte mit Abdeckplatte auf dem Boden - schwenkbar - mit Trafo

Ref

2374.9.INOX

Lamp type

QR-LP111 G53 (1) 75W 12V  
or QR-LP111 G53 (1) 50W 12V

Dimensions

Ø250xH320

Ø155  320

 9mm glass - Glas

build-in  
105VA

# OUTDOOR | In-ground luminaires | LAVA GRANDE cover on the floor

## 2375.9/.. - LAVA GRANDE cover on the floor

~230V  IP66   0,5 m  



floorlight with cover plate on the floor - fixed  
Bodenleuchte mit Abdeckplatte auf dem Boden - fest

Ref  
2375.9.INOX

### Lamp type

TC-TSE E27Ls (1) 23W 230V

### Dimensions

Ø250xH320  $\wedge$  40° reflector

Ø155  $\sqrt{L}$  320

9mm glass - Glas

build-in  
other °angle reflector on demand  
andere °Winkel Reflektor auf Anfrage

## 2376.9/.. - LAVA GRANDE cover on the floor

~230V  IP66   1 m  



floorlight with cover plate on the floor - fixed - with magnetic gear  
Bodenleuchte mit Abdeckplatte auf dem Boden - fest - mit magnetischem Vorschaltgerät

Ref  
2376.9.INOX

### Lamp type

HIT-CE G12 (1) 35W 230V

### Dimensions

Ø250xH320  $\wedge$  30° reflector

Ø155  $\sqrt{L}$  320

9mm glass - Glas

build-in  
70W on request - other °angle reflector on demand  
70W auf Anfrage - andere °Winkel Reflektor auf Anfrage

## 2377.9/.. - LAVA GRANDE cover on the floor

~230V  IP66   1 m  



floorlight with cover plate on the floor - directional - with magnetic gear  
Bodenleuchte mit Abdeckplatte auf dem Boden - schwenkbar - mit magnetischem Vorschaltgerät

Ref  
2377.9.INOX

### Lamp type

HIR-CE111 GX8,5 (1) 35W 230V

### Dimensions

Ø250xH320

Ø155  $\sqrt{L}$  320

9mm glass - Glas

build-in  
70W on request  
70W auf Anfrage

## 2380.9/.. - LAVA GRANDE cover on the floor

~12V   IP66   1 m  



floorlight with cover plate on the floor - directional - without transformer  
Bodenleuchte mit Abdeckplatte auf dem Boden - schwenkbar - ohne Trafo

Ref  
2380.9.INOX

### Lamp type

QR-LP111 G53 (1) 100W 12V  
or QR-LP111 G53 (1) 50W 12V

### Dimensions

L250xB250xH150

Ø155  $\sqrt{L}$  150

9mm glass - Glas

build-in



2381.9/.. - LAVA GRANDE cover on the floor

~230V



floorlight with cover plate on the floor - directional  
Bodenleuchte mit Abdeckplatte auf dem Boden - schwenkbar

Ref  
2381.9.INOX

Lamp type

QPAR 111 GU10 (1) 75W 230V

Dimensions

L250xB250xH150

Ø155 H 150

9mm glass - Glas

build-in

2383.9/.. - LAVA GRANDE cover on the floor

~230V



floorlight with cover plate on the floor - fixed  
Bodenleuchte mit Abdeckplatte auf dem Boden - fest

Ref  
2383.9.INOX

Lamp type

TC-HSE E27 (1) 20W 230V

Dimensions

L250xB250xH235 40° reflector

Ø155 H 235

9mm glass - Glas

build-in

2384.9/.. - LAVA GRANDE cover on the floor

~230V

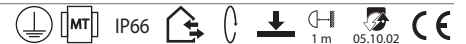

floorlight with cover plate on the floor - directional - with transformer  
Bodenleuchte mit Abdeckplatte auf dem Boden - schwenkbar - mit Trafo

Ref  
2384.9.INOX

Lamp type

QR-LP111 G53 (1) 75W 12V

Dimensions

L250xB250xH320

Ø155 H 320

9mm glass - Glas

build-in  
105VA

2385.9/.. - LAVA GRANDE cover on the floor

~230V



floorlight with cover plate on the floor - fixed  
Bodenleuchte mit Abdeckplatte auf dem Boden - fest

Ref  
2385.9.INOX

Lamp type

TC-TSE E27Ls (1) 23W 230V

Dimensions

L250xB250xH320 40° reflector

Ø155 H 320

9mm glass - Glas

build-in  
other °angle reflector on demand  
andere °Winkel Reflektor auf Anfrage

2386.9/.. - LAVA GRANDE cover on the floor

~230V



floorlight with cover plate on the floor - fixed - with magnetic gear  
 Bodenleuchte mit Abdeckplatte auf dem Boden - fest - mit magnetischem Vorschaltgerät

Ref

2386.9.INOX

Lamptype

HIT-CE G12 (1) 35W 230V

Dimensions

L250xB250xH320 30° reflector  
 Ø155 320  
 9mm glass - Glas

build-in

70W on request - other °angle reflector on demand  
 70W auf Anfrage - andere °Winkel Reflektor auf Anfrage

2387.9/.. - LAVA GRANDE cover on the floor

~230V

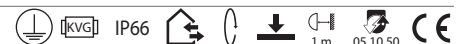

floorlight with cover plate on the floor - directional - with magnetic gear  
 Bodenleuchte mit Abdeckplatte auf dem Boden - schwenkbar - mit magnetischem Vorschaltgerät

Ref

2387.9.INOX

Lamptype

HIR-CE111 GX8,5 (1) 35W 230V

Dimensions

L250xB250xH320 40° reflector  
 Ø155 320  
 9mm glass - Glas

build-in

70W on request  
 70W auf Anfrage

1180.9/.. - LAVA GRANDE

IP20



accessories for floorlight - cover plate  
 Zubehör für Bodenleuchte - Abdeckplatte

Ref

1180.9.INOX

Dimensions

Ø180xH15  
 9mm glass - Glas

1181.9/.. - LAVA GRANDE

IP20



accessories for floorlight - cover plate with border  
 Zubehör für Bodenleuchte - Abdeckplatte mit Rand

Ref

1181.9.INOX

Dimensions

Ø180xH15  
 9mm glass - Glas

1182/.. - LAVA GRANDE



IP20   0,0100 

accessories for floorlight  
Zubehör für Bodenleuchte

Ref  
1182



00GLASLAVAD140.9M/.. - LAVA GRANDE

IP20   0,3650 

spare glass - clear glass for lava grande  
Ersatzglas - klares Glas für Lava grande  
9mm glass - Glas

Ref  
00GLASLAVAD140.9M



00HERSTGLASD140.9MM/.. - LAVA GRANDE

IP20   

spare glass + repair - glue new glass in cover plate  
Ersatzglas + Reparatur - neues Glas in Abdeckplatte  
einleimen  
9mm glass - Glas

Ref  
00HERSTGLASD140.9MM



In-ground luminaires outdoor



**PONTOS**

T401/./.. P.570



**PONTOS**

T406/./.. P.572



**PICUS**

T470/./.. P.571



**NEMEA**

W701B/.. P.571



**HALIA**

W702/.. P.571



**DELIA**

T460/./.. P.573



**ZENIT**

T427.700/.. P.574



**DELFI**

T418.60/.. P.575



**METIS**

W703/.. P.572



**POLO**

W708.D/.. P.574



**KRIOS**

T440/./.. P.575



**ARGOS**

T420/./.. P.575



**KADMOS**

T430/./.. P.576



**VENUS**

T414/./.. P.576



**LEDA**

W501/.. P.576



**NANA**

W503/.. P.577



**HEMERA**

W601/.. P.577



**ARIMA**

W602/.. P.577



**LIPARA**

W603/.. P.577



**PORTO**

T300.250/.. P.579



**PORTO**

T299.450/.. P.579



**PORTO**

W299/.. P.581



**MAURO**

W707/.. P.573



**NIKE**

T400/.. P.578



**TOLEDO**

T303R/.. P.582



**TOLEDO**

T303S/.. P.582



**TOLEDO**

T304R/.. P.583



**TOLEDO**

W303/./S P.585



**TOLEDO**

W304/./S P.585



**ELBA-SCALA-PALMA-TOSSA-BIBLOS**

T483/./.. P.586



T486/./.. P.587



T489/./.. P.588



T492/./.. P.589



W506/.. P.587



**DAKAR**

T205/./.. P.590



T206/.. P.590



T207/.. P.590



**GOTA**

W1830/.. P.611



W1831/.. P.612



**STONE**

W1212/.. P.591



W1211/.. P.591



W1216/.. P.592



**ICARO**

W1221.5X/.. P.593



**AVENUE**

T498/./.. P.593



**CONSUL**

T500/./.. P.594



T500/.. P.594



W500/.. P.594



**CYCLOPE**

T312.85/.. P.594



**CYCLOPE**

T314/.. P.595



**HORIZON**

T310.1345/.. P.595



**HORIZON**

T311.2000/.. P.595



**FARO**

T424.600/.. P.596



**SUISSE**

T499/./.. P.598



**MINOS**

T410/./.. P.597



**IRIS**

T101.C/./.. P.598



**DIONE**

W709/.. P.600



**DIONE**

W710/.. P.600



**DIONE**

W717/.. P.600



**EXTER**

W1208.35W/.. P.611



**UFO**

W1070/.. P.601



**UFO**

W1072/.. P.601



**UFO**

T1033/.. P.602



**UFO**

T1039.65/.. P.604



**UFO GRANDE**

W7071/.. P.606



**UFO GRANDE**

W7073/.. P.606



**UFO GRANDE**

T7036.45/.. P.608



**UFO GRANDE**

T7039.65/.. P.609



**VOLARE**

T1206.A/.. P.610



**UFO GRANDE**

T1206.C/.. P.611



ARGOS	575
ARIMA	577
AVENUE	593
BIBLOS	589
CLEAN	612
CONSUL	594
CYCLOPE	594, 595
DAKAR	590
DELFI	575
DELIA	573
DIONE	600
ELBA	586
EXTER	611
FARO	596
GOTA	611, 612
HALIA	571, 572
HEMERA	577
HORIZON	595
ICARO	593
IRIS	598, 599
IRIS Type C	598, 599
KADMOS	576
KRIOS	575
LEDA	576
LIPARA	577
MAURO	573
METIS	572
MINOS	597
NANA	577
NEMEA	571
NIKE	578, 579
PALMA	588
PICUS	571
POLO	573, 574
PONTOS	570, 572, 573
PORTO	579, 580, 581
SCALA	587
SPIKE grondpin	578
STONE	591, 592
STONE box	591, 592
SUISSE	597, 598
SUPPORT FOR FLOODLIGHT	578
TOLEDO	582, 583, 584, 585, 586
TOLEDO SPIKE	583
TOSSA	589
UFO	601, 602, 603, 604, 605
UFO GRANDE	606, 607, 608, 609, 610
VENUS	576
VOLARE	610, 611
ZENIT	574

**T401/././.. - PONTOS**

~230V



bollard - 1 opening - with magnetic gear  
Pollerleuchte - 1 Loch - mit magnetischem Vorschaltgerät

**Lamptype**

TC-D G24D-1 (1) 13W 230V

**Dimensions**

L70xB70

**Options**

T1001/.. - SPIKE grondpin

Colour	T401.1000/..	T401.300/..	T401.400/..	T401.600/..	T401.800/..
	H 1000	H 300	H 400	H 600	H 800
5B					

**T450/././.. - PONTOS**

~230V



bollard - 3 openings - with magnetic gear  
Pollerleuchte - 3 Löcher - mit magnetischem Vorschaltgerät

**Lamptype**

TC-D G24D-1 (1) 13W 230V

**Dimensions**

L70xB70

**Options**

T1001/.. - SPIKE grondpin

Colour	T450.1000/..	T450.400/..	T450.600/..	T450.800/..
	H 1000	H 400	H 600	H 800
5B				

**T403.600/.. - PONTOS**

~230V



bollard with powerpoint - 1 opening - with magnetic gear  
Pfahl mit Steckdose - 1 Loch - mit magnetischem Vorschaltgerät

**Ref**

T403.600.5B

**Lamptype**

TC-D G24D-1 (1) 13W 230V

**Dimensions**

L80xB80xH600

L80xB80

**Options**

T1001/.. - SPIKE grondpin

**T453.600/.. - PONTOS**

~230V

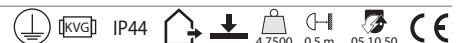

bollard with powerpoint - 3 openings - with powerpoint - with magnetic gear  
Pfahl mit Steckdose - 3 Löcher - mit 1 Steckdose - mit magnetischem Vorschaltgerät

**Ref**

T453.600.5B

**Lamptype**

TC-D G24D-1 (1) 13W 230V

**Dimensions**

L80xB80xH600

L80xB80

**Options**

T1001/.. - SPIKE grondpin

T470/... - PICUS

~230V   IP66   0,5 m  05.10.50 



bollard - 2 openings - with magnetic gear  
Pollerleuchte - 2 Löcher - mit magnetischem Vorschaltgerät

**Lamptype**

← TC-D G24D-1 (1) 13W 230V

**Dimensions**

↔ L70xB70

Colour	T470.1000/..	T470.400/..	T470.600/..	T470.800/..
	H 1000	H 400	H 600	H 800
	5B			

W701/.. - NEMEA

~230V   IP44   2,0200  0,5 m  05.10.50 



build-up wall light - 1 opening - with magnetic gear  
Wandleuchte für Aufbau - 1 Loch - mit magnetischem Vorschaltgerät

**Ref**

W701.5B

**Lamptype**

← TC-D G24D-1 (1) 13W 230V

**Dimensions**

↔ B70xH250xD250

W701B/.. - NEMEA

~230V   IP44   1,5650  0,5 m  05.10.50 



build-up wall light - 3 openings - with magnetic gear  
Wandleuchte für Aufbau - 3 Löcher - mit magnetischem Vorschaltgerät

**Ref**

W701B.5B

**Lamptype**

← TC-D G24D-1 (1) 13W 230V

**Dimensions**

↔ B70xH250xD250

W702/.. - HALIA

~230V   IP44   2,7100  0,5 m  05.10.50 



build-up wall light - 1 opening - with magnetic gear  
Wandleuchte für Aufbau - 1 Loch - mit magnetischem Vorschaltgerät

**Ref**

W702.5B

W702.32

**Lamptype**

← TC-D G24D-1 (2) 13W 230V

**Dimensions**

↔ B135xH250xD250

**W702B/.. - HALIA**

~230V



build-up wall light - 3 openings - with magnetic gear  
Wandleuchte für Aufbau - 3 Löcher - mit magnetischem  
Vorschaltgerät

**Ref**

W702B.5B

**Lamptype**

← TC-D G24D-1 (2) 13W 230V

**Dimensions**

↔ B135xH250xD250

**W703/.. - METIS**

~230V



build-up wall light - 3 openings - with magnetic gear  
Wandleuchte für Aufbau - 3 Löcher - mit magnetischem  
Vorschaltgerät

**Ref**

W703.5B

W703.21B

**Lamptype**

← TC-D G24D-1 (1) 13W 230V

**Dimensions**

↔ B80xH340xD95

**W704/.. - METIS**

~230V



build-up wall light - 3 openings - with magnetic gear  
Wandleuchte für Aufbau - 3 Löcher - mit magnetischem  
Vorschaltgerät

**Ref**

W704.5B

W704.21B

**Lamptype**

← TC-D G24D-1 (2) 13W 230V

**Dimensions**

↔ B135xH340xD95

**T406/./.. - PONTOS**

~230V



bollard - 1 opening - with magnetic gear  
Pollerleuchte - 1 Loch - mit magnetischem Vorschaltgerät

**Lamptype**

← TC-D G24D-1 (2) 13W 230V

**Dimensions**

↔ L130xB78

⊥ L150xB150

**Options**

T1001/.. - SPIKE groundpin

Colour	T406.1000/..	T406.400/..	T406.600/..	T406.800/..
	H 1000	H 400	H 600	H 800
	5B			



T454/././ - PONTOS

~230V   IP66    0,5 m  05.10.50 



bollard - 3 openings - with magnetic gear  
Pollerleuchte - 3 Löcher - mit magnetischem Vorschaltgerät

**Lamptype**  
TC-D G24D-1 (2) 13W 230V

**Dimensions**  
L 130xB78  
L 150xB150

**Options**  
T1001/.. - SPIKE grondpin

Colour	T454.1000/..	T454.400/..	T454.600/..	T454.800/..
	H 1000	H 400	H 600	H 800
5B				

T460/././ - DELIA

~230V   IP23    0,5 m  05.10.02 



bollard - with transformer  
Pollerleuchte - mit Trafo

**Lamptype**  
QR-CB 51 GU5,3/GX5,3 (1) 50W 12V

**Dimensions**  
L 70xB70

**Options**  
T1001/.. - SPIKE grondpin

Colour	T460.1000/..	T460.400/..	T460.600/..	T460.800/..
	H 1000	H 400	H 600	H 800
5B				

W707/.. - MAURO

~230V   IP54    1,4933  0,5 m  05.10.02 



build-up wall light - with transformer  
Wandleuchte für Aufbau - mit Trafo

**Lamptype**  
QR-CB 51 GU5,3/GX5,3 (2) 50W 12V

**Dimensions**  
B70xH220xD140  
B60xH130xD50

**Ref**  
W707.5  
W707.5B  
W707.21B

W708.A/.. - POLO

~230V   IP44    1 m  05.10.50 



build-up wall light - with magnetic gear  
Wandleuchte für Aufbau - mit magnetischem Vorschaltgerät

**Lamptype**  
QPAR 51 GU10 (2) 50W 230V  
TC-D G24D-2 (1) 18W 230V

**Dimensions**  
B180xH359xD90

**Ref**  
W708.A.5  
W708.A.5B  
W708.A.5BB  
W708.A.36

**W708.B/.. - POLO**

~230V   IP44   0,7000  0,5 m  05.10.50 



build-up wall light - with magnetic gear  
Wandleuchte für Aufbau - mit magnetischem Vorschaltgerät

**Ref**

W708.B.5  
W708.B.5B  
W708.B.5BB  
W708.B.36

**Lamptype**

TC-D G24D-2 (1) 18W 230V

**Dimensions**

↔ B180xH269xD90

**W708.C/.. - POLO**

~230V   IP44   1 m  05.10.50 



build-up wall light - with magnetic gear  
Wandleuchte für Aufbau - mit magnetischem Vorschaltgerät

**Ref**

W708.C.5  
W708.C.5B  
W708.C.5BB  
W708.C.36

**Lamptype**

TC-D G24D-1 (1) 13W 230V

QPAR-CB 51 GZ10 (2) 50W 230V

**Dimensions**

↔ B200xH290xD90

**W708.D/.. - POLO**

~230V   IP44   0,5 m  05.10.50 



build-up wall light - with magnetic gear  
Wandleuchte für Aufbau - mit magnetischem Vorschaltgerät

**Ref**

W708.D.5  
W708.D.5B  
W708.D.5BB  
W708.D.36

**Lamptype**

TC-D G24D-1 (1) 13W 230V

**Dimensions**

↔ B200xH200xD90

**T427.700/.. - ZENIT**

~230V   IP65   4,8800  0,5 m  05.10.02 



bollard - with transformer  
Pollerleuchte - mit Trafo

**Ref**

T427.700.5B

**Lamptype**

QR-CB 51 GU5,3/GX5,3 (1) 50W 12V

**Dimensions**

↔ L80xB80xH700

☛ L150xB150

**Options**

T1001/.. - SPIKE grondpin

T418.60/.. - DELFI

~230V  IP54   0,5 m  05.10.02 



bollard  
Pollerleuchte

Ref

T418.60.5B

Lamptype

 TC-HSE E27 (1) 20W 230V

Dimensions

 L70xB70xH600

Options

T1001/.. - SPIKE grondpin

T419.80/.. - DELFI

~230V   IP54   0,5 m  05.10.50 



bollard - with magnetic gear  
Pollerleuchte - mit magnetischem Vorschaltgerät

Ref

T419.80.5B

Lamptype

 TC-L 2G11 (1) 24W 230V

Dimensions

 L70xB70xH800

Options

T1001/.. - SPIKE grondpin

T440/... - KRIOS

~230V   IP44   0,5 m  05.10.02 





bollard - with transformer  
Pollerleuchte - mit Trafo

Lamptype

 QR-CB 51 GU5,3/GX5,3 (1) 50W 12V

Dimensions

 L180xB170

 L150xB150

Options

T1001/.. - SPIKE grondpin

Colour	T440.1000/..	T440.400/..	T440.600/..	T440.800/..
	H 1000	H 400	H 600	H 800
5B				
21B				

T420/... - ARGOS

~230V   IP44   0,5 m  05.10.02 





bollard - with transformer  
Pollerleuchte - mit Trafo

Lamptype

 QR-CB 51 GU5,3/GX5,3 (1) 50W 12V

Dimensions

 L135xB220

 L150xB150

Options

T1001/.. - SPIKE grondpin

Colour	T420.1000/..	T420.400/..	T420.600/..	T420.800/..
	H 1000	H 400	H 600	H 800
5B				
21B				

**T430/... - KADMOS**

~230V   IP44     



bollard - with transformer  
Pollerleuchte - mit Trafo

**Lamptype**

◁ QR-CB 51 GU5,3/GX5,3 (2) 50W 12V

**Dimensions**

↔ L 320xB135

⌞ L 150xB150

**Options**

T1001/.. - SPIKE grondpin

Colour	T430.1000/..	T430.400/..	T430.600/..	T430.800/..
	H 1000	H 400	H 600	H 800
5B				
21B				

**T414/... - VENUS**

~230V   IP44     



bollard - with transformer  
Pollerleuchte - mit Trafo

**Lamptype**

◁ QR-CB 51 GU5,3/GX5,3 (1) 50W 12V

**Dimensions**

↔ L 135xB190

⌞ L 150xB150

**Options**

T1001/.. - SPIKE grondpin

Colour	T414.1000/..	T414.400/..	T414.600/..	T414.800/..
	H 1000	H 400	H 600	H 800
5B				
21B				

**W600/.. - VENUS**

~230V   IP44      



build-up wall light - with transformer  
Wandleuchte für Aufbau - mit Trafo

**Ref**

W600.5B

W600.21B

**Lamptype**

◁ QR-CB 51 GU5,3/GX5,3 (1) 50W 12V

**Dimensions**

↔ B 135xH 200xD 170

**W501/.. - LEDA**

~12V   IP44      



build-up wall light - without transformer  
Wandleuchte für Aufbau - ohne Trafo

**Ref**

W501.5B

**Lamptype**

◁ QR-CB 51 GU5,3/GX5,3 (1) 50W 12V

**Dimensions**

↔ B 135xH 100xD 120

**W503/.. - NANA**

~230V   IP44    0,6800  0,5 m  05.10.02 



build-up wall light - with transformer  
Wandleuchte für Aufbau - mit Trafo

**Ref**

W503.5B

W503.21B

**Lamptype**

◁ QR-CB 51 GU5,3/GX5,3 (1) 50W 12V

**Dimensions**

↔ B135xH100xD220

**W601/.. - HEMERA**

~230V   IP44    1,2150  0,5 m  05.10.02 



build-up wall light - with transformer  
Wandleuchte für Aufbau - mit Trafo

**Ref**

W601.5B

W601.21B

**Lamptype**

◁ QR-CB 51 GU5,3/GX5,3 (1) 50W 12V

**Dimensions**

↔ B180xH180xD175

**W602/.. - ARIMA**

~230V   IP44    2,0400  0,5 m  05.10.02 



build-up wall light - with transformer  
Wandleuchte für Aufbau - mit Trafo

**Ref**

W602.5B

W602.21B

**Lamptype**

◁ QR-CB 51 GU5,3/GX5,3 (2) 50W 12V

**Dimensions**

↔ B360xH180xD175

**W603/.. - LIPARA**

~230V   IP44    1,7000  0,5 m  05.10.02 



build-up wall light - with transformer  
Wandleuchte für Aufbau - mit Trafo

**Ref**

W603.5B

W603.21B

**Lamptype**

◁ QR-CB 51 GU5,3/GX5,3 (1) 50W 12V

**Dimensions**

↔ B180xH360xD175

**Options**

C96/.. - NUMBER

houses number to order separately - article C000  
Hausnummer separat bestellen - Artikel C000

**T1001/.. - SPIKE grondpin**

IP20   1,0600 



universal spike  
universeller Erdspeiß

Ref

T1001

**Dimensions**

↔ L150xB150xH400

for Pontos - Picus - Nike - Suisse etc.  
für Pontos - Picus - Nike - Suisse usw.

**T490/.. - SUPPORT FOR FLOODLIGHT**

IP20   0,1713 



wall support M20 for floodlight - M20  
Wandbefestigung für Scheinwerfer - M20

Ref

T490.5

T490.5B

T490.32

T490.36

**Dimensions**

↔ L80xB85xH500

**T397/.. - NIKE**

~230V  IP44   1,2860  



bollard with powerpoint - 1 powerpoint  
Pfahl mit Steckdose - 1 Steckdose

Ref

T397.5

T397.5B

T397.21B

T397.32

T397.36

**Dimensions**

↔ L84xB55xH240

⊣ L150xB150

**Options**

T1001/.. - SPIKE grondpin

switch on demand  
Schalter auf Anfrage

**T400/.. - NIKE**

~230V  IP44   2,1682  



bollard with powerpoint - 2 powerpoints  
Pfahl mit Steckdose - 2 Steckdosen

Ref

T400.5

T400.5B

T400.21B

T400.32

T400.36

**Dimensions**

↔ L84xB55xH345

⊣ L150xB150

**Options**

T1001/.. - SPIKE grondpin

switch on demand  
Schalter auf Anfrage

**T398/.. - NIKE**

~230V  IP44   2,7880  0,5 m 



bollard with powerpoint - 6 powerpoints  
Pfahl mit Steckdose - 6 Steckdosen

**Dimensions**

↔ L84xB55xH650

⚡ L150xB150

**Options**

T1001/.. - SPIKE grondpin

**Ref**

T398.5

T398.5B

T398.21B

T398.32

T398.36

switches on demand  
Schalter auf Anfrage

**T399/.. - NIKE**

~230V  IP44   2,4190  0,5 m 



bollard with powerpoint - 4 powerpoints  
Pfahl mit Steckdose - 4 Steckdosen

**Dimensions**

↔ L84xB55xH520

⚡ L150xB150

**Options**

T1001/.. - SPIKE grondpin

**Ref**

T399.5

T399.5B

T399.21B

T399.32

T399.36

switches on demand  
Schalter auf Anfrage

**T299.250/.. - PORTO**

~230V  IP44   1 m  05.10.02 



bollard - standard sandblasted white glass  
Pollerleuchte - standard weiß sandgestrahltes Glas

**Lamp type**

⦿ TCC-SE E14 (1) 7W 230V

**Dimensions**

↔ L92xB92xH250

⚡ L120xB120

**Options**

T1001/.. - SPIKE grondpin

**Ref**

T299.250.5

T299.250.5B

T299.250.38.5

T299.250.38.5B

\*new lamp holder\*  
\*neue Fassung\*

**T299.450/.. - PORTO**

~230V  IP44   1 m  05.10.02 



bollard - standard sandblasted white glass  
Pollerleuchte - standard weiß sandgestrahltes Glas

**Lamp type**

⦿ TCC-SE E14 (1) 7W 230V

**Dimensions**

↔ L92xB92xH450

⚡ L120xB120

**Options**

T1001/.. - SPIKE grondpin

**Ref**

T299.450.5

T299.450.5B

T299.450.38.5

T299.450.38.5B

\*new lamp holder\*  
\*neue Fassung\*



T299.750/.. - PORTO

~230V  IP44    1 m  05.10.02 



bollard - standard sandblasted white glass  
Pollerleuchte - standard weiß sandgestrahltes Glas

**Lamptype**

 TCC-SE E14 (1) 7W 230V

**Dimensions**

 L92xB92xH750

 L120xB120

**Options**

T1001/.. - SPIKE grondpin

**Ref**

T299.750.5  
T299.750.5B  
T299.750.38.5  
T299.750.38.5B

\*new lamp holder\*  
\*neue Fassung\*

T300.250/.. - PORTO

~230V  IP44    2,4400  1 m  05.10.02 



bollard - standard sandblasted white glass  
Pollerleuchte - standard weiß sandgestrahltes Glas

**Lamptype**

 QT14 G9 (1) 40W 230V

or  CFL G9 (1) 7W 230V

**Dimensions**

 L92xB92xH250

 L120xB120

**Options**

T1001/.. - SPIKE grondpin

**Ref**

T300.250.5  
T300.250.5B  
T300.250.38.5  
T300.250.38.5B

T300.450/.. - PORTO

~230V  IP44    1,9938  1 m  05.10.02 



bollard - standard sandblasted white glass  
Pollerleuchte - standard weiß sandgestrahltes Glas

**Lamptype**

 QT14 G9 (1) 40W 230V

or  CFL G9 (1) 7W 230V

**Dimensions**

 L92xB92xH450

 L120xB120

**Options**

T1001/.. - SPIKE grondpin

**Ref**

T300.450.5  
T300.450.5B  
T300.450.38.5  
T300.450.38.5B

T300.750/.. - PORTO

~230V  IP44    5,1325  1 m  05.10.02 



bollard - standard sandblasted white glass  
Pollerleuchte - standard weiß sandgestrahltes Glas

**Lamptype**

 QT14 G9 (1) 40W 230V

or  CFL G9 (1) 7W 230V

**Dimensions**

 L92xB92xH750

 L120xB120

**Options**

T1001/.. - SPIKE grondpin

**Ref**

T300.750.5  
T300.750.5B  
T300.750.38.5  
T300.750.38.5B



W299/.. - PORTO

~230V  IP44   2,7500  1 m  05.10.02 



bollard - standard sandblasted white glass  
Pollerleuchte - standard weiß sandgestrahltes Glas

Ref

W299.5  
W299.5B  
W299.38.5  
W299.38.5B

Lamp type

TCC-SE E14 (1) 7W 230V

Dimensions

B92xH235xD145  
B70xH70xD30

\*new lamp holder\*  
\*neue Fassung\*

W300/.. - PORTO

~230V  IP44   2,7500  1 m  05.10.02 



bollard - standard sandblasted white glass  
Pollerleuchte - standard weiß sandgestrahltes Glas

Ref

W300.5  
W300.5B  
W300.38.5  
W300.38.5B

Lamp type

QT14 G9 (1) 40W 230V  
or CFL G9 (1) 7W 230V

Dimensions

B92xH235xD145  
B70xH70xD30

2320.230V/.. - TYPE A : LED CASSETTE 230V 3,6W IP65

~230V  IP65    05.10.02 



accessories for garden lighting - fixed - not dimmable  
Zubehör für Gartenleuchten - fest - nicht dimmbar

Ref

2320.230V.NW

Lamp type

led 230V . (1) 3,6W 230V

Dimensions

Ø70

Options

LAVA-ETNA LED  
TOLEDO FLOOR OR WALL

Niko-Erea LED - NW 4000K

2320.24V/.. - TYPE B : LED CASSETTE 24V-DC 3,6W IP65

=24V-DC   IP65    05.10.02 



accessories for garden lighting - fixed - not dimmable -  
without transformer  
Zubehör für Gartenleuchten - fest - nicht dimmbar - ohne  
Trafo

Ref

2320.24V.NW

Lamp type

led 24V-DC . (1) 3,6W 24V-DC

Dimensions

Ø70

Options

LAVA-ETNA LED  
TOLEDO FLOOR OR WALL

Niko-Erea LED - NW 4000K - parallel connection  
Parallelschaltung

T303R/.. - TOLEDO

~230V



IP44



0,7300

0,5 m



05.10.02



bollard  
Pollerleuchte

**Lamptype**

⌀ TC-FSE GX53 (1) 9W 230V

**Dimensions**

↔ L100xB40

**Options**

2320.230V/.. - TYPE A : LED CASSETTE 230V 3,6W IP65

2320.24V/.. - TYPE B : LED CASSETTE 24V-DC 3,6W IP65

T305/.. - TOLEDO SPIKE

Colour	T303.150R/.. H 150	T303.400R/.. H 400	T303.600R/.. H 600
5			
5B			
5BB			
21B			
32			
37			

T303S/.. - TOLEDO

~230V



IP44



0,5 m



05.10.02



bollard  
Pollerleuchte

**Lamptype**

⌀ TC-FSE GX53 (2) 9W 230V

**Dimensions**

↔ L100xB40

**Options**

2320.230V/.. - TYPE A : LED CASSETTE 230V 3,6W IP65

2320.24V/.. - TYPE B : LED CASSETTE 24V-DC 3,6W IP65

T305/.. - TOLEDO SPIKE

Colour	T303.150S/.. H 150	T303.400S/.. H 400	T303.600S/.. H 600
5			
5B			
5BB			
21B			
32			
37			

T305/.. - TOLEDO SPIKE

IP20   0,4850 



spike  
Erdspieß

Ref  
T305

**Dimensions**

↔ L100xB40xH250

T304R/.. - TOLEDO

~230V  IP44   0,5 m  05.10.02 



bollard  
Pollerleuchte

**Lamptype**

⌀ TC-FSE GX53 (2) 9W 230V

**Dimensions**

↔ L100xB100

**Options**

2320.230V/.. - TYPE A : LED CASSETTE 230V 3,6W IP65

2320.24V/.. - TYPE B : LED CASSETTE 24V-DC 3,6W IP65

T307/.. - TOLEDO SPIKE

Colour	T304.150R/..	T304.400R/..	T304.600R/..
	H 150	H 400	H 600
5			
5B			
21B			
32			
37			



Inox Stainless steel 316 outdoor

T304S/.. - TOLEDO

~230V  IP44   0,5 m  05.10.02 



bollard  
Pollerleuchte

**Lamptype**

⊙ TC-FSE GX53 (2) 9W 230V

**Dimensions**

↔ L100xB100

**Options**

2320.230V/.. - TYPE A : LED CASSETTE 230V 3,6W IP65

2320.24V/.. - TYPE B : LED CASSETTE 24V-DC 3,6W IP65

T307/.. - TOLEDO SPIKE

Colour	T304.150S/..	T304.400S/..	T304.600S/..
	H 150	H 400	H 600
5			
5B			
21B			
32			
37			

T307/.. - TOLEDO SPIKE

IP20   1,0500  



spike  
Erdspieß

**Ref**

T307

**Dimensions**

↔ L100xB100xH250

W303/..R - TOLEDO

~230V  IP44   0,5 m  05.10.02 



house number luminaire to build up  
Hausnummernleuchte für Aufbau

**Ref**

W303.5.R  
W303.5B.R  
W303.21B.R  
W303.32.R  
W303.37.R

**Lamptype**

⊙ TC-FSE GX53 (1) 9W 230V

**Dimensions**

↔ B100xH185xD155

⊕ B100xH185

**Options**

2320.230V/.. - TYPE A : LED CASSETTE 230V 3,6W IP65

2320.24V/.. - TYPE B : LED CASSETTE 24V-DC 3,6W IP65

C50/.. - NUMBER

LA/.. - LETTER

*build-up  
numbers or letters to order separately  
Ziffern oder Buchstaben separat bestellen*

**W303/..S - TOLEDO**

~230V  IP44    0,5 m  05.10.02 



*build-up  
numbers or letters to order separately  
Ziffern oder Buchstaben separat bestellen*

house number luminaire to build up  
Hausnummernleuchte für Aufbau

**Lamptype**

TC-FSE GX53 (1) 9W 230V

**Dimensions**

B100xH185xD155

B100xH185

**Options**

2320.230V/.. - TYPE A : LED CASSETTE 230V 3,6W IP65

2320.24V/.. - TYPE B : LED CASSETTE 24V-DC 3,6W IP65

C50/.. - NUMBER

LA/.. - LETTER

**Ref**

- W303.5.S
- W303.5B.S
- W303.21B.S
- W303.32.S
- W303.37.S

**W304/..R - TOLEDO**

~230V  IP44    0,5 m  05.10.02 



*build-up*

build-up wall light  
Wandleuchte für Aufbau

**Lamptype**

TC-FSE GX53 (1) 9W 230V

**Dimensions**

B100xH255xD72

B130xH100

**Options**

2320.230V/.. - TYPE A : LED CASSETTE 230V 3,6W IP65

2320.24V/.. - TYPE B : LED CASSETTE 24V-DC 3,6W IP65

**Ref**

- W304.5.R
- W304.5B.R
- W304.21B.R
- W304.32.R
- W304.37.R

**W304/..S - TOLEDO**

~230V  IP44    0,5 m  05.10.02 

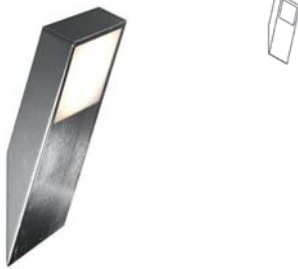

*build-up*

build-up wall light  
Wandleuchte für Aufbau

**Lamptype**

TC-FSE GX53 (1) 9W 230V

**Dimensions**

B100xH255xD72

B130xH100

**Options**

2320.230V/.. - TYPE A : LED CASSETTE 230V 3,6W IP65

2320.24V/.. - TYPE B : LED CASSETTE 24V-DC 3,6W IP65

**Ref**

- W304.5.S
- W304.5B.S
- W304.21B.S
- W304.32.S
- W304.37.S

**W306/..R - TOLEDO**

~230V  IP44    0,5 m  05.10.02 



*build-up*

build-up wall light  
Wandleuchte für Aufbau

**Lamptype**

TC-FSE GX53 (1) 9W 230V

**Dimensions**

B100xH150xD42

B100xH150

**Options**

2320.230V/.. - TYPE A : LED CASSETTE 230V 3,6W IP65

2320.24V/.. - TYPE B : LED CASSETTE 24V-DC 3,6W IP65

**Ref**

- W306.5.R
- W306.5B.R
- W306.21B.R
- W306.32.R
- W306.37.R

**W306/..S - TOLEDO**

~230V  IP44   0,5750  0,5 m  05.10.02 



build-up wall light  
Wandleuchte für Aufbau

**Lamptype**

TC-FSE GX53 (1) 9W

230V

**Dimensions**

↔ B100xH150xD42

⌞ B100xH150

**Options**

2320.230V/.. - TYPE A : LED CASSETTE 230V 3,6W IP65

2320.24V/.. - TYPE B : LED CASSETTE 24V-DC 3,6W IP65

**Ref**

W306.5.S

W306.5B.S

W306.21B.S

W306.32.S

W306.37.S

build-up

**T483/..../.. - ELBA**

~230V  IP54   2,1900  0,5 m  05.10.02 



bollard  
Pollerleuchte

**Lamptype**

TC-HSE E27 (1) 20W

230V

**Dimensions**

↔ L100xB100

⌞ L150xB150

**Options**

T1001/.. - SPIKE grondpin

Colour	T483.1000/..	T483.600/..	T483.800/..
	H 1000	H 600	H 800
	5		
	5B		
	38		

**W505/.. - ELBA**

~230V  IP44   2,1900  0,5 m  05.10.02 



build-up wall light  
Wandleuchte für Aufbau

**Lamptype**

TC-HSE E27 (1) 20W

230V

**Dimensions**

↔ B100xH228xD136

**Ref**

W505.5B

T486/... - SCALA

~230V  IP66   0,5 m  05.10.02 



bollard  
Pollerleuchte

Lamp type

 TC-HSE E27 (1) 20W 230V

Dimensions

 L 100xB100

 L 150xB150

Options

T1001/.. - SPIKE groundpin

Colour	T486.1000/..	T486.600/..	T486.800/..
	H 1000	H 600	H 800
	5		
	5B		
	38		

W506/.. - SCALA

~230V  IP44   0,5 m  05.10.02 



build-up wall light  
Wandleuchte für Aufbau

Ref

W506.5B

Lamp type

 TC-HSE E27 (1) 20W 230V

Dimensions

 B100xH283xD136



T489/... - PALMA

~230V



IP54



9,6000

0,5 m

05.10.02



bollard  
Pollerleuchte

**Lamptype**

TC-HSE E27 (1) 20W 230V

**Dimensions**

L 100xB100

L 150xB150

**Options**

T1001/.. - SPIKE grondpin

Colour	T489.1000/..	T489.600/..	T489.800/..
	H 1000	H 600	H 800
	5		
	5B		
	38		

W507/.. - PALMA

~230V



IP44



0,5 m

05.10.02



build-up wall light  
Wandleuchte für Aufbau

**Ref**

W507.5B

**Lamptype**

TC-HSE E27 (1) 20W 230V

**Dimensions**

B100xH253xD136



T492/... - TOSSA

~230V  IP54   0,5 m  



bollard  
Pollerleuchte

**Lamptype**

 TC-HSE E27 (1) 20W 230V

**Dimensions**

 L100xB100

 L150xB150

**Options**

T1001/.. - SPIKE grondpin

Colour	T492.1000/..	T492.600/..	T492.800/..
	H 1000	H 600	H 800
	5		
	5B		
	38		

W508/.. - TOSSA

~230V  IP44    0,5 m  



build-up wall light  
Wandleuchte für Aufbau

**Ref**

W508.5B

**Lamptype**

 TC-HSE E27 (1) 20W 230V

**Dimensions**

 B100xH283xD136

W510/.. - BIBLOS

~230V  IP44    0,5 m  



build-up wall light  
Wandleuchte für Aufbau

**Ref**

W510.5B

**Lamptype**

 TC-HSE E27 (1) 20W 230V

**Dimensions**

 B100xH253xD110

T205/././.. - DAKAR



bollard - with electronic gear  
Pollerleuchte - mit elektronischem Vorschaltgerät

**Lamp type**

⇒ T16FQ T5 G5 (3) 24W 230V

**Dimensions**

↔ L 120xB120

⌞ L 200xB200

Colour	T205.1000/..	T205.1500/..	T205.2000/..	T205.2500/..
	H 1000	H 1500	H 2000	H 2500
5B				
32				
37				

T206/.. - DAKAR



bollard - with electronic gear  
Pollerleuchte - mit elektronischem Vorschaltgerät

**Ref**

T206.5B

**Lamp type**

⇒ T16FH T5 G5 (2) 21W 230V

**Dimensions**

↔ L 3000

⌞ L 600xB300

T207/.. - DAKAR



bollard - with electronic gear  
Pollerleuchte - mit elektronischem Vorschaltgerät

**Ref**

T207.5B

**Lamp type**

⇒ T16FQ T5 G5 (3) 24W 230V

T207.32

**Dimensions**

↔ L 120xB120xH3000

T207.37

⌞ L 200xB200

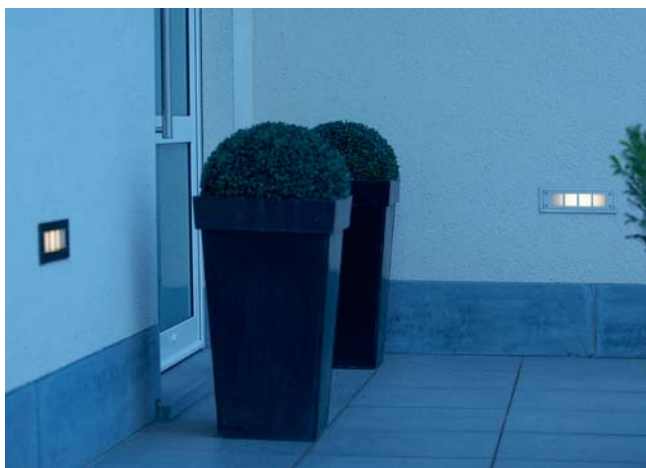

W1210/.. - STONE

~230V  IP44    0,6200  1 m  05.10.02 



build-in wall light - no build-in box required  
Einbau Wandleuchte - Einbaudose nicht notwendig

Ref  
W1210.5

Lamptype

 QT14 G9 (1) 25W 230V

Dimensions

 B100xH67xD90

 107x68  90

build-in

W1212/.. - STONE

~230V  S2 IP44    0,7600  1 m  05.10.02 



build-in wall light  
Einbau Wandleuchte



Ref  
W1212.5

Lamptype

 QT14 G9 (1) 25W 230V

Dimensions

 B125xH85xD90

 108x72  101

Options

W1213B/.. - STONE box

build-in

W1211/.. - STONE

~230V  S2 IP44    0,6200  1 m  05.10.02 



build-in wall light  
Einbau Wandleuchte



Ref  
W1211.5

Lamptype

 QT14 G9 (1) 25W 230V

Dimensions

 B125xH85xD90

 108x72  101

Options

W1213B/.. - STONE box

build-in

W1213B/.. - STONE box

IP20    0,1050 

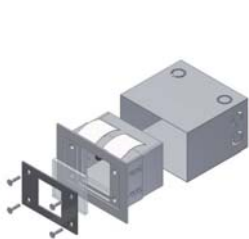

build-in box - for W1212  
Einbaudose - für W1212

Ref  
W1213B

Dimensions

 B112xH70xD100

**W1214/.. - STONE**

~230V



build-in wall light - no build-in box required - with magnetic gear  
Einbau Wandleuchte - Einbaudose nicht notwendig - mit magnetischem Vorschaltgerät

**Ref**

W1214.5



**Lamptype**

← TC-S G23 (1) 9W 230V

**Dimensions**

↔ B240xH65xD70

📏 244x67 ∟ 90

build-in

**W1216/.. - STONE**

~230V



build-in wall light - with magnetic gear  
Einbau Wandleuchte - mit magnetischem Vorschaltgerät

**Ref**

W1216.5



**Lamptype**

← TC-S G23 (1) 9W 230V

**Dimensions**

↔ B260xH85xD73

📏 246x67 ∟ 101

**Options**

W1217B/.. - STONE box

build-in

**W1215/.. - STONE**

~230V



build-in wall light - with magnetic gear  
Einbau Wandleuchte - mit magnetischem Vorschaltgerät

**Ref**

W1215.5



**Lamptype**

← TC-S G23 (1) 9W 230V

**Dimensions**

↔ B260xH85xD73

📏 246x67 ∟ 101

**Options**

W1217B/.. - STONE box

build-in

**W1217B/.. - STONE box**

IP20



build-in box - for W1216 & W1215  
Einbaudose - für W1216 & W1215

**Ref**

W1217B

**Dimensions**

↔ B250xH70xD100

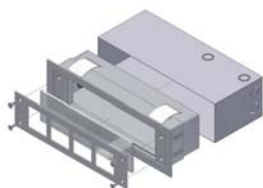

W1220.40X/.. - ICARO

~230V   S2 IP54     



build-in wall light - build-in box included - with magnetic gear  
Einbau Wandleuchte - inklusive Einbaudose - mit magnetischem Vorschaltgerät

Ref

**Lamptype**

TC-D G24D-3 (1) 26W 230V

**Dimensions**

B260xH260xD80  
260x260 80

build-in

W1221.5X/.. - ICARO

~230V   S2 IP54      



build-in wall light - build-in box included - with magnetic gear  
Einbau Wandleuchte - inklusive Einbaudose - mit magnetischem Vorschaltgerät

Ref

W1221.5X.5

**Lamptype**

TC-D G24D-3 (1) 26W 230V

**Dimensions**

B280xH280xD80  
260x260x90 90

build-in

T498/..../.. - AVENUE

~230V  IP54     



bollard  
Pollerleuchte

**Lamptype**

TC-HSE E27 (1) 15W 230V

**Dimensions**

Ø105  
Ø120

Colour	T498.1000/..	T498.400/..	T498.600/..	T498.800/..
	H 1000	H 400	H 600	H 800
	5			
	5B			
	32			



T500/... - CONSUL

~230V  IP54    0.5 m  05.10.02 



bollard  
Pollerleuchte

**Lamptype**

☛ TC-HSE E27 (1) 20W 230V

**Dimensions**

↔ Ø102

Colour	T500.1000/..	T500.200/..	T500.400/..	T500.600/..	T500.800/..
	H 1000	H 200	H 400	H 600	H 800
	5				
	5B				

T500/.. - CONSUL

~230V  IP44    0.5 m  05.10.02 



ceiling light  
Deckenleuchte

**Ref**

T500.5  
T500.5B

**Lamptype**

☛ TC-HSE E27 (1) 20W 230V

**Dimensions**

↔ Ø102xH200

W500/.. - CONSUL

~230V  IP54    3,3000  0.5 m  05.10.02 



build-up wall light  
Wandleuchte für Aufbau

**Ref**

W500.5  
W500.5B

**Lamptype**

☛ TC-HSE E27 (1) 20W 230V

**Dimensions**

↔ Ø102xH235

T312.85/.. - CYCLOPE

~230V  IP54    7,1400  1 m  05.10.02 



bollard - with transformer  
Pollerleuchte - mit Trafo

**Ref**

T312.85.5  
T312.85.5B

**Lamptype**

☛ QR-LP111 G53 (1) 75W 12V

**Dimensions**

↔ Ø130xH850

T313.85/.. - CYCLOPE

~230V  IP54   1 m  05.10.02 



bollard  
Pollerleuchte

Ref

T313.85.5

Lamptype

T313.85.5B

 TC-HSE E27 (1) 20W

230V

Dimensions

 Ø130xH850

T314/.. - CYCLOPE

~230V  IP65   1 m  05.10.02 



bollard  
Pollerleuchte

Ref

T314.5

Lamptype

T314.5B

 TC-HSE E27 (1) 20W

230V

Dimensions

 Ø130xH850

T314.21B

T314.32M

T314.36

T310.1345/.. - HORIZON

~230V   IP54   3,7000  0,5 m  05.10.50 



bollard - with electronic gear  
Pollerleuchte - mit elektronischem Vorschaltgerät

Ref

T310.1345.5

Lamptype

T310.1345.5B

 T16FQ T5 G5 (1) 24W

230V

Dimensions

 Ø80xH1345

 Ø120

T311.2000/.. - HORIZON

~230V   IP54   0,5 m  05.10.50 



bollard - with electronic gear  
Pollerleuchte - mit elektronischem Vorschaltgerät

Ref

T311.2000.5B

Lamptype

T311.2000.32

 T16FQ T5 G5 (2) 24W

230V

Dimensions

 Ø115xH2000

 Ø130

T311.2000.37

T424.600/.. - FARO

~230V



bollard  
Pollerleuchte

Ref

T424.600.5B

Lamptype

TC-HSE E27 (1) 20W

230V

Dimensions

Ø70xH600

Ø120



T425/./.. - FARO

~230V



bollard - with magnetic gear  
Pollerleuchte - mit magnetischem Vorschaltgerät

Lamptype

TC-L 2G11 (1) 24W

230V

Dimensions

Ø70

Ø120

Colour	T425.1000/..	T425.800/..
	H 1000	H 800
5B		
5BB		



T410/././ - MINOS

~230V



bollard - with transformer  
Pollerleuchte - mit Trafo

Lamptype

QR-CB 51 GU5,3/GX5,3 (1) 50W 12V

Dimensions

Ø60

Colour	T410.1000/..	T410.1200/..	T410.600/..	T410.800/..
	H 1000	H 1200	H 600	H 800
5B				

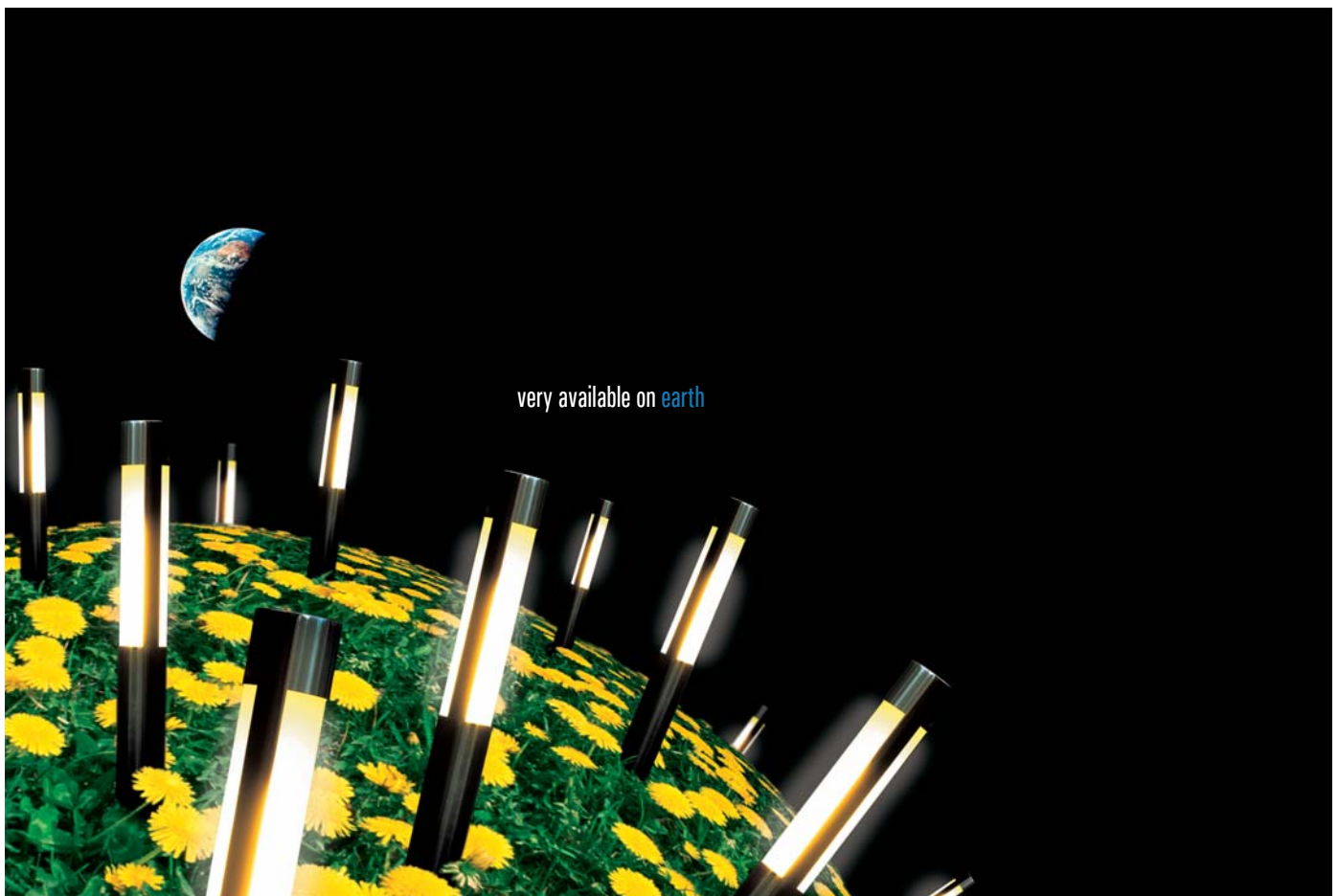

very available on earth

T599/././ - SUISSE

~230V



bollard - 1 opening - with magnetic gear  
Pollerleuchte - 1 Loch - mit magnetischem Vorschaltgerät

Lamptype

TC-L 2G11 (1) 24W 230V

Dimensions

Ø70

Ø120

Colour	T599.1000/..	T599.600/..	T599.800/..
	H 1000	H 600	H 800
5B			
5BB			

T499/./.. - SUISSE

~230V



bollard - 2 openings - with magnetic gear  
Pollerleuchte - 2 Löcher - mit magnetischem Vorschaltgerät

Lamp type

TC-L 2G11 (1) 24W 230V

Dimensions

↔ Ø70

⚙️ Ø120

Colour	T499.1000/..	T499.600/..	T499.800/..
	H 1000	H 600	H 800
5B			
5BB			

T101.C/./.. - IRIS

~230V



bollard  
Pollerleuchte

Lamp type

mini lynx longlife E27 (1) 11W 230V

Dimensions

↔ Ø90

Options

T1021.T30/.. - IRIS

T1021.T5/.. - IRIS

T1021/.. - IRIS - CUBA SPIKE

T1027/.. - IRIS Type C

Colour	T1011C/..	T1012C/..	T1013C/..	T1014C/..	T1015C/..
	H 260	H 460	H 660	H 860	H 1060
5					
5B					
30					
32					
34					
35					
36					

W1054C/.. - IRIS

~230V



build-up wall light  
Wandleuchte für Aufbau

Lamp type

mini lynx longlife E27 (1) 11W 230V

Dimensions

↔ Ø53xH420xD230

Options

T1027/.. - IRIS Type C

Ref

- W1054C.5
- W1054C.5B
- W1054C.31
- W1054C.32
- W1054C.34
- W1054C.35
- W1054C.36

build-up



W1058CX/.. - IRIS

~230V



build-up wall light  
Wandleuchte für Aufbau

Ref

W1058CX.5

W1058CX.5B

Lamp type

mini lynx longlife E27 (1) 11W 230V

Dimensions

Ø54xH335xD110

Options

T1027/.. - IRIS Type C

build-up

T1027/.. - IRIS Type C



accessories for garden lighting - type C  
Zubehör für Gartenleuchten - Typ C

Ref

T1027.5

T1027.5B

T1027.31

T1027.32

T1027.34

T1027.35

T1027.36

Dimensions

Ø53xH250

T1021.T30/.. - IRIS



spike - for red copper  
Erdspieß - für rotes Kupfer

Ref

T1021.T30

T1021.T5/.. - IRIS



spike - for stainless steel  
Erdspieß - für Edelstahl

Ref

T1021.T5

**W709/.. - DIONE**

~230V



build-up wall light - with opal white glass  
Wandleuchte für Aufbau - mit opalweißem Glas

**Ref**

- W709.5
- W709.5B
- W709.5BB
- W709.21B
- W709.30
- W709.36

**Lamptype**

TC-HSE E27 (1) 11W 230V

**Dimensions**

Ø60xH200xD100  
L80xB50

build-up

**W710/.. - DIONE**

~230V



build-up wall light - up or down  
Wandleuchte für Aufbau - up oder down

**Ref**

- W710.5
- W710.5B
- W710.5BB
- W710.21B
- W710.30
- W710.36

**Lamptype**

QPAR 51 GU10 (1) 50W 230V

**Dimensions**

Ø60xH100xD100  
L80xB50

build-up

also available with energy saving light bulb Megaman 11W  
auch lieferbar mit Sparlampe Megaman 11W

**W717/.. - DIONE**

~230V



build-up wall light  
Wandleuchte für Aufbau

**Ref**

- W717.5
- W717.5B
- W717.5BB
- W717.21B
- W717.30
- W717.36

**Lamptype**

QPAR 51 GU10 (2) 50W 230V

**Dimensions**

Ø60xH240xD100  
L80xB50

build-up

also available with energy saving light bulb Megaman 11W  
auch lieferbar mit Sparlampe Megaman 11W

**W716/.. - DIONE**

~230V



build-up wall light - with transformer  
Wandleuchte für Aufbau - mit Trafo

**Ref**

- W716.5
- W716.5B
- W716.5BB
- W716.21B
- W716.30
- W716.36

**Lamptype**

QR-CB 51 coolfit GU5,3/GX5,3 (2) 50W 12V

**Dimensions**

Ø60xH240xD135  
L130xB60

build-up

use coolfit lamp  
Coolfit-Lampe verwenden

**W1070/.. - UFO**

~12V 0,2983 0,5 m 05.10.02



build-up wall light - with glass - without transformer  
Wandleuchte für Aufbau - mit Glas - ohne Trafo

**Ref**

**Lamptype**

QR-CB 51 coolfit GU5,3/GX5,3 (1) 35W 12V

**Dimensions**

Ø60xD167

Ø60

W1070.5  
W1070.5B  
W1070.5BB  
W1070.32  
W1070.36  
W1070.37

*build-up*  
use coolfit lamp  
Coolfit-Lampe verwenden

**W1071/.. - UFO**

~230V 2,4490 0,5 m 05.10.02



build-up wall light - with glass - with transformer  
Wandleuchte für Aufbau - mit Glas - mit Trafo

**Ref**

**Lamptype**

QR-CB 51 coolfit GU5,3/GX5,3 (1) 35W 12V

**Dimensions**

B70xH70xD207

L70xB70

W1071.5  
W1071.5B  
W1071.5BB  
W1071.32  
W1071.36  
W1071.37

*build-up*  
60VA - use coolfit lamp  
Coolfit-Lampe verwenden

**W1072/.. - UFO**

~230V 1,2067 0,5 m 05.10.02



build-up wall light - with glass - with transformer  
Wandleuchte für Aufbau - mit Glas - mit Trafo

**Ref**

**Lamptype**

QR-CB 51 coolfit GU5,3/GX5,3 (2) 35W 12V

**Dimensions**

B200xH55xD287

L200xB55

W1072.5  
W1072.5B  
W1072.5BB  
W1072.32  
W1072.36  
W1072.37

*build-up*  
105VA - use coolfit lamp  
Coolfit-Lampe verwenden

**W1073/.. - UFO**

~230V 2,5700 0,5 m 05.10.02



build-up wall light - with glass - with transformer  
Wandleuchte für Aufbau - mit Glas - mit Trafo

**Ref**

**Lamptype**

QR-CB 51 coolfit GU5,3/GX5,3 (1) 35W 12V

**Dimensions**

B70xH70xD610

L70xB70

W1073.5  
W1073.5B  
W1073.5BB  
W1073.32  
W1073.36  
W1073.37

*build-up*  
60VA - use coolfit lamp  
Coolfit-Lampe verwenden

T1033/.. - UFO

~230V



bollard with spike - with glass - with transformer  
Pollerleuchte mit Erdspieß - mit Glas - mit Trafo

Ref

T1033.5  
T1033.5B  
T1033.5BB  
T1033.32  
T1033.36  
T1033.37

Lamptype

QR-CB 51 coolfit GU5,3/GX5,3 (1) 35W 12V

Dimensions

↔ Ø60xH450

60VA - use coolfit lamp  
Coolfit-Lampe verwenden

T1034/.. - UFO

~230V



bollard with spike - with glass - with transformer  
Pollerleuchte mit Erdspieß - mit Glas - mit Trafo

Ref

T1034.5  
T1034.5B  
T1034.5BB  
T1034.32  
T1034.36  
T1034.37

Lamptype

QR-CB 51 coolfit GU5,3/GX5,3 (1) 35W 12V

Dimensions

↔ Ø60xH650

60VA - use coolfit lamp  
Coolfit-Lampe verwenden

T1035/.. - UFO

~230V



bollard with spike - with glass - with transformer  
Pollerleuchte mit Erdspieß - mit Glas - mit Trafo

Ref

T1035.5  
T1035.5B  
T1035.5BB  
T1035.32  
T1035.36  
T1035.37

Lamptype

QR-CB 51 coolfit GU5,3/GX5,3 (1) 35W 12V

Dimensions

↔ Ø60xH850

60VA - use coolfit lamp  
Coolfit-Lampe verwenden

T1037/.. - UFO

~230V



bollard with spike - with glass - with transformer  
Pollerleuchte mit Erdspieß - mit Glas - mit Trafo

Ref

T1037.5  
T1037.5B  
T1037.5BB  
T1037.32  
T1037.36  
T1037.37

Lamptype

QR-CB 51 coolfit GU5,3/GX5,3 (2) 35W 12V

Dimensions

↔ Ø60xL310xH650

2x60VA - use coolfit lamp  
Coolfit-Lampe verwenden

T1038/.. - UFO

~230V   IP44    1,5552  0,5 m  05.10.02 



bollard with spike - with glass - with transformer  
Pollerleuchte mit Erdspieß - mit Glas - mit Trafo

Ref

- T1038.5
- T1038.5B
- T1038.5BB
- T1038.32
- T1038.36
- T1038.37

Lamptype

 QR-CB 51 coolfit GU5,3/GX5,3 (2) 35W 12V

Dimensions

 Ø60xL310xH850

2x60VA - use coolfit lamp  
Coolfit-Lampe verwenden

T1036.45/.. - UFO

~230V   IP44    6,6187  0,5 m  05.10.02 



bollard - with glass - with transformer  
Pollerleuchte - mit Glas - mit Trafo

Ref

- T1036.45.5
- T1036.45.5B
- T1036.45.5BB
- T1036.45.32
- T1036.45.36
- T1036.45.37

Lamptype

 QR-CB 51 coolfit GU5,3/GX5,3 (1) 35W 12V

Dimensions

 L100xB100xH450

 L100xB100

60VA - use coolfit lamp  
Coolfit-Lampe verwenden

T1036.65/.. - UFO

~230V   IP44    6,7928  0,5 m  05.10.02 



bollard - with glass - with transformer  
Pollerleuchte - mit Glas - mit Trafo

Ref

- T1036.65.5
- T1036.65.5B
- T1036.65.5BB
- T1036.65.32
- T1036.65.36
- T1036.65.37

Lamptype

 QR-CB 51 coolfit GU5,3/GX5,3 (1) 35W 12V

Dimensions

 L100xB100xH650

 L100xB100

60VA - use coolfit lamp  
Coolfit-Lampe verwenden

T1036.85/.. - UFO

~230V   IP44    9,1797  0,5 m  05.10.02 



bollard - with glass - with transformer  
Pollerleuchte - mit Glas - mit Trafo

Ref

- T1036.85.5
- T1036.85.5B
- T1036.85.5BB
- T1036.85.32
- T1036.85.36
- T1036.85.37

Lamptype

 QR-CB 51 coolfit GU5,3/GX5,3 (1) 35W 12V

Dimensions

 L100xB100xH850

 L100xB100

60VA - use coolfit lamp  
Coolfit-Lampe verwenden

T1039.65/.. - UFO

~230V   IP44    0,8582  0,5 m  05.10.02 



bollard - with glass - with transformer  
Pollerleuchte - mit Glas - mit Trafo

Ref

- T1039.65.5
- T1039.65.5B
- T1039.65.5BB
- T1039.65.32
- T1039.65.36
- T1039.65.37

Lamp type

 QR-CB 51 coolfit GU5,3/GX5,3 (2) 35W 12V

Dimensions

 L310xB100xH650

 L100xB100

2x60VA - use coolfit lamp  
Coolfit-Lampe verwenden

T1039.85/.. - UFO

~230V   IP44    5,5023  0,5 m  05.10.02 



bollard - with glass - with transformer  
Pollerleuchte - mit Glas - mit Trafo

Ref

- T1039.85.5
- T1039.85.5B
- T1039.85.5BB
- T1039.85.32
- T1039.85.36
- T1039.85.37

Lamp type

 QR-CB 51 coolfit GU5,3/GX5,3 (2) 35W 12V

Dimensions

 L310xB100xH850

 L100xB100

2x60VA - use coolfit lamp  
Coolfit-Lampe verwenden

T1030/.. - UFO

~12V   IP44    0,5601  0,5 m  05.10.02 



bollard with spike - with 1,5m cable - with glass - without transformer  
Pollerleuchte mit Erdspeiß - mit 1,5m Kabel - mit Glas - ohne Trafo

Ref

- T1030.5
- T1030.5B
- T1030.5BB
- T1030.32
- T1030.36
- T1030.37

Lamp type

 QR-CB 51 coolfit GU5,3/GX5,3 (1) 35W 12V

Dimensions

 Ø60xH400

use coolfit lamp - alu spike  
Coolfit-Lampe verwenden - Erdspeiß in Alu

T1030/.. /5M - UFO

~12V   IP66    0,1592  0,5 m  05.10.02 



bollard with spike - with 5m cable - without transformer  
Pollerleuchte mit Erdspeiß - mit 5m Kabel - ohne Trafo

Ref

- T1030.5.5M
- T1030.5B.5M
- T1030.5BB.5M
- T1030.32.5M
- T1030.36.5M
- T1030.37.5M

Lamp type

 QR-CB 51 coolfit GU5,3/GX5,3 (1) 35W 12V

Dimensions

 Ø60xH400

use coolfit lamp - alu spike  
Coolfit-Lampe verwenden - Erdspeiß in Alu



T1031/.. - UFO

~230V



bollard with spike - with glass - with transformer  
Pollerleuchte mit Erdspieß - mit Glas - mit Trafo

Lamp type

QR-CB 51 coolfit GU5,3/GX5,3 (1) 35W 12V

Dimensions

L70xB70xH400

Ref

T1031.5  
T1031.5B  
T1031.5BB  
T1031.32  
T1031.36  
T1031.37

60VA - use coolfit lamp  
Coolfit-Lampe verwenden

T1032/.. - UFO

~230V



bollard with spike - with glass - with transformer  
Pollerleuchte mit Erdspieß - mit Glas - mit Trafo

Lamp type

QR-CB 51 coolfit GU5,3/GX5,3 (2) 35W 12V

Dimensions

L200xB60xH400

Ref

T1032.5  
T1032.5B  
T1032.5BB  
T1032.32  
T1032.36  
T1032.37

105VA - use coolfit lamp  
Coolfit-Lampe verwenden

00 UFOSEALINGRING/..12V - UFO

IP20 0,1890



supplement - sealing ring  
Supplement - Dichtungsring

Ref

00 UFOSEALINGRING.12V



## OUTDOOR | Stainless steel 316 | UFO GRANDE

UNIVERSAL UFO - Head IP65 (Ø64xH125) for several types of lamps and wattages. To be mentioned on the order: e.g. QPAR51 GU10 230V - 50W / 11W (energy saving) / 7W (LED) - 12V on request - UNIVERSELLER UFO - Kopf IP65 (Ø64xH125) für verschiedene Lamptypen und Wattleistungen. Auf der Bestellung erwähnen: z.B. QPAR51 GU10 230V - 50W / 11W (Sparlampe) / 7W (LED) - 12V auf Anfrage

### W7070/.. - UFO GRANDE

~230V



build-up wall light - with glass  
Wandleuchte für Aufbau - mit Glas

Ref

W7070.5

#### Lamptype

☞ QPAR 51 GU10 (1) 50W 230V

W7070.5B

or ☞ QPAR 51 LED GU10 (1) 7W 230V

W7070.5BB

#### Dimensions

↔ Ø60

W7070.32

W7070.36

W7070.37

build-up

### W7071/.. - UFO GRANDE

~230V



build-up wall light - with glass  
Wandleuchte für Aufbau - mit Glas

Ref

W7071.5

#### Lamptype

☞ QPAR 51 GU10 (1) 50W 230V

W7071.5B

or ☞ QPAR 51 LED GU10 (1) 7W 230V

W7071.5BB

#### Dimensions

↔ B70xH70

W7071.32

W7071.36

W7071.37

build-up

### W7072/.. - UFO GRANDE

~230V



build-up wall light - with glass  
Wandleuchte für Aufbau - mit Glas

Ref

W7072.5

#### Lamptype

☞ QPAR 51 GU10 (2) 50W 230V

W7072.5B

or ☞ QPAR 51 LED GU10 (2) 7W 230V

W7072.5BB

#### Dimensions

↔ B200xH55

W7072.32

W7072.36

W7072.37

build-up

### W7073/.. - UFO GRANDE

~230V



build-up wall light - with glass  
Wandleuchte für Aufbau - mit Glas

Ref

W7073.5

#### Lamptype

☞ QPAR 51 GU10 (1) 50W 230V

W7073.5B

or ☞ QPAR 51 LED GU10 (1) 7W 230V

W7073.5BB

#### Dimensions

↔ B70xH70xD610

W7073.32

W7073.36

☛ B70xH70

W7073.37

build-up

## OUTDOOR | Stainless steel 316 | UFO GRANDE

UNIVERSAL UFO - Head IP65 (Ø64xH125) for several types of lamps and wattages. To be mentioned on the order: e.g. QPAR51 GU10 230V - 50W / 11W (energy saving) / 7W (LED) - 12V on request - UNIVERSELLER UFO - Kopf IP65 (Ø64xH125) für verschiedene Lamptypen und Wattleistungen. Auf der Bestellung erwähnen: z.B. QPAR51 GU10 230V - 50W / 11W (Sparlampe) / 7W (LED) - 12V auf Anfrage

### T7033.45/.. - UFO GRANDE

~230V



bollard with spike - with glass  
Pollerleuchte mit Erdspieß - mit Glas

#### Ref

T7033.45.5

#### Lamptype

☞ QPAR 51 GU10 (1) 50W 230V

T7033.45.5B

or ☞ QPAR 51 LED GU10 (1) 7W 230V

T7033.45.5BB

#### Dimensions

↔ H450

T7033.45.32

T7033.45.36

T7033.45.37

### T7033.65/.. - UFO GRANDE

~230V



bollard with spike - with glass  
Pollerleuchte mit Erdspieß - mit Glas

#### Ref

T7033.65.5

#### Lamptype

☞ QPAR 51 GU10 (1) 50W 230V

T7033.65.5B

or ☞ QPAR 51 LED GU10 (1) 7W 230V

T7033.65.5BB

#### Dimensions

↔ H650

T7033.65.32

T7033.65.36

T7033.65.37

### T7033.85/.. - UFO GRANDE

~230V



bollard with spike - with glass  
Pollerleuchte mit Erdspieß - mit Glas

#### Ref

T7033.85.5

#### Lamptype

☞ QPAR 51 GU10 (1) 50W 230V

T7033.85.5B

or ☞ QPAR 51 LED GU10 (1) 7W 230V

T7033.85.5BB

#### Dimensions

↔ H850

T7033.85.32

T7033.85.36

T7033.85.37

### T7037.65/.. - UFO GRANDE

~230V



bollard with spike - with glass  
Pollerleuchte mit Erdspieß - mit Glas

#### Ref

T7037.65.5

#### Lamptype

☞ QPAR 51 GU10 (2) 50W 230V

T7037.65.5B

or ☞ QPAR 51 LED GU10 (2) 7W 230V

T7037.65.5BB

#### Dimensions

↔ H650

T7037.65.32

T7037.65.36

T7037.65.37

Inox Stainless steel 316 outdoor

## OUTDOOR | Stainless steel 316 | UFO GRANDE

UNIVERSAL UFO - Head IP65 (Ø64xH125) for several types of lamps and wattages. To be mentioned on the order: e.g. QPAR51 GU10 230V - 50W / 11W (energy saving) / 7W (LED) - 12V on request - UNIVERSELLER UFO - Kopf IP65 (Ø64xH125) für verschiedene Lamptypen und Wattleistungen. Auf der Bestellung erwähnen: z.B. QPAR51 GU10 230V - 50W / 11W (Sparlampe) / 7W (LED) - 12V auf Anfrage

### T7037.85/.. - UFO GRANDE

~230V  IP54    2,0400  0.5 m  05.10.02  



bollard with spike - with glass  
Pollerleuchte mit Erdspiß - mit Glas

#### Ref

T7037.85.5

#### Lamptype

 QPAR 51 GU10 (2) 50W 230V

T7037.85.5B

or  QPAR 51 LED GU10 (2) 7W 230V

T7037.85.5BB

T7037.85.32

#### Dimensions

 H850

T7037.85.36

T7037.85.37

### T7036.45/.. - UFO GRANDE

~230V  IP54    0,5 m  05.10.02  



bollard - with glass  
Pollerleuchte - mit Glas

#### Ref

T7036.45.5

#### Lamptype

 QPAR 51 GU10 (1) 50W 230V

T7036.45.5B

or  QPAR 51 LED GU10 (1) 7W 230V

T7036.45.5BB

T7036.45.32

#### Dimensions

 H450

T7036.45.36

T7036.45.37

### T7036.65/.. - UFO GRANDE

~230V  IP54    0,5 m  05.10.02  



bollard - with glass  
Pollerleuchte - mit Glas

#### Ref

T7036.65.5

#### Lamptype

 QPAR 51 GU10 (1) 50W 230V

T7036.65.5B

or  QPAR 51 LED GU10 (1) 7W 230V

T7036.65.5BB

T7036.65.32

#### Dimensions

 H650

T7036.65.36

T7036.65.37

### T7036.85/.. - UFO GRANDE

~230V  IP54    0,5 m  05.10.02  



bollard - with glass  
Pollerleuchte - mit Glas

#### Ref

T7036.85.5

#### Lamptype

 QPAR 51 GU10 (1) 50W 230V

T7036.85.5B

or  QPAR 51 LED GU10 (1) 7W 230V

T7036.85.5BB

T7036.85.32

#### Dimensions

 H850

T7036.85.36

T7036.85.37

## OUTDOOR | Stainless steel 316 | UFO GRANDE

UNIVERSAL UFO - Head IP65 (Ø64xH125) for several types of lamps and wattages. To be mentioned on the order: e.g. QPAR51 GU10 230V - 50W / 11W (energy saving) / 7W (LED) - 12V on request - UNIVERSELLER UFO - Kopf IP65 (Ø64xH125) für verschiedene Lamptypen und Wattleistungen. Auf der Bestellung erwähnen: z.B. QPAR51 GU10 230V - 50W / 11W (Sparlampe) / 7W (LED) - 12V auf Anfrage

### T7039.65/.. - UFO GRANDE

~230V



bollard - with glass  
Pollerleuchte - mit Glas

#### Ref

T7039.65.5  
T7039.65.5B  
T7039.65.5BB  
T7039.65.32  
T7039.65.36  
T7039.65.37

#### Lamptype

☞ QPAR 51 GU10 (2) 50W 230V  
or ☞ QPAR 51 LED GU10 (2) 7W 230V

#### Dimensions

↔ H650

### T7039.85/.. - UFO GRANDE

~230V



bollard - with glass  
Pollerleuchte - mit Glas

#### Ref

T7039.85.5  
T7039.85.5B  
T7039.85.5BB  
T7039.85.32  
T7039.85.36  
T7039.85.37

#### Lamptype

☞ QPAR 51 GU10 (2) 50W 230V  
or ☞ QPAR 51 LED GU10 (2) 7W 230V

#### Dimensions

↔ H850

### T7030/.. - UFO GRANDE

~230V



bollard with spike - with 1,5m cable - with glass  
Pollerleuchte mit Erdspieß - mit 1,5m Kabel - mit Glas

#### Ref

T7030.5  
T7030.5B  
T7030.5BB  
T7030.32  
T7030.36  
T7030.37

#### Lamptype

☞ QPAR 51 GU10 (1) 50W 230V  
or ☞ QPAR 51 LED GU10 (1) 7W 230V

#### Dimensions

↔ H400

### T7030/..5M - UFO GRANDE

~230V



bollard with spike - with 5m cable  
Pollerleuchte mit Erdspieß - mit 5m Kabel

#### Ref

T7030.5.5M  
T7030.5B.5M  
T7030.5BB.5M  
T7030.32.5M  
T7030.36.5M  
T7030.37.5M

#### Lamptype

☞ QPAR 51 GU10 (1) 50W 230V  
or ☞ QPAR 51 LED GU10 (1) 7W 230V

#### Dimensions/Abmessungen

↔ H400

## OUTDOOR | Stainless steel 316 | UFO GRANDE | UFO | VOLARE

UNIVERSAL UFO - Head IP65 (Ø64xH125) for several types of lamps and wattages. To be mentioned on the order: e.g. QPAR51 GU10 230V - 50W / 11W (energy saving) / 7W (LED) - 12V on request - UNIVERSELLER UFO - Kopf IP65 (Ø64xH125) für verschiedene Lamptypen und Wattleistungen. Auf der Bestellung erwähnen: z.B. QPAR51 GU10 230V - 50W / 11W (Sparlampe) / 7W (LED) - 12V auf Anfrage

### T7031/.. - UFO GRANDE

~230V  IP44    1,1150  0,5 m  05.10.02 



bollard with spike - with glass  
Pollerleuchte mit Erdspieß - mit Glas

#### Ref

T7031.5  
T7031.5B  
T7031.5BB  
T7031.32  
T7031.36  
T7031.37

#### Lamptype

 QPAR 51 GU10 (1) 50W 230V  
or  QPAR 51 LED GU10 (1) 7W 230V

#### Dimensions

 L70xB70xH400

### T7032/.. - UFO GRANDE

~230V  IP44    0,5 m  05.10.02 



bollard with spike - with glass  
Pollerleuchte mit Erdspieß - mit Glas

#### Ref

T7032.5  
T7032.5B  
T7032.5BB  
T7032.32  
T7032.36  
T7032.37

#### Lamptype

 QPAR 51 GU10 (2) 50W 230V  
or  QPAR 51 GU10 (2) 7W 230V

#### Dimensions

 L200xB60xH400

### 00 UFOSEALINGRING/.. /230V - UFO

IP20   0,1890 

supplement - sealing ring  
Supplement - Dichtungsring

#### Ref

00 UFOSEALINGRING.230V

### T1206.A/.. - VOLARE

~230V  EVG  IP66   33,0000  1 m  05.10.50 



pole lighting/lantern - directional - with electronic gear  
Mastbeleuchtung/Laterne - schwenkbar - mit elektronischem Vorschaltgerät

#### Ref

T1206.A.5  
T1206.A.5B

#### Lamptype

 HIT-TC-CE G8,5 (1) 70W 230V

#### Dimensions

 B690xH3080

 Ø256



**T1206.C/.. - VOLARE**

~230V   IP66   43,000  1 m  05.10.50 



pole lighting/lantern - directional - with electronic gear  
Mastbeleuchtung/Laterne - schwenkbar - mit elektronischem Vorschaltgerät

**Ref**  
T1206.C.5  
T1206.C.5B

**Lamptype**  
HIT-TC-CE G8,5 (2) 70W 230V

**Dimensions**  
B1320xH3080  
Ø256



**W1208.35W/.. - EXTER**

~230V   IP44   1 m  05.10.50 



build-up wall light - directional - with electronic gear  
Wandleuchte für Aufbau - schwenkbar - mit elektronischem Vorschaltgerät

**Ref**  
W1208.35W.40.5  
W1208.35W.40.5B

**Lamptype**  
HIT-TC-CE G8,5 (1) 35W 230V

**Dimensions**  
B180xH360xD150

\*new model\*  
\*neues Modell\*

**W1208.70W/.. - EXTER**

~230V   IP44   1 m  05.10.50 



build-up wall light - directional - with electronic gear  
Wandleuchte für Aufbau - schwenkbar - mit elektronischem Vorschaltgerät

**Ref**  
W1208.70W.40.5  
W1208.70W.40.5B

**Lamptype**  
HIT-TC-CE G8,5 (1) 70W 230V

**Dimensions**  
B180xH360xD150

**W1830/.. - GOTA**

~230V   IP44   5,0250  0,5 m  05.10.50 



bollard - with stainless steel base Ø250mm - with electronic gear  
Pollerleuchte - mit Fuß in Edelstahl Ø250mm - mit elektronischem Vorschaltgerät

**Ref**  
W1830.5

**Lamptype**  
T16FHT5 G5 (2) 21W 230V

**Dimensions**  
Ø250xH1300



W1831/.. - GOTA

~230V



bollard - with stainless steel base Ø350mm - with electronic gear  
 Pollerleuchte - mit Fuß in Edelstahl Ø350mm - mit elektronischem Vorschaltgerät

Ref

W1831.5

Lamptype

⇒ T16FHT5 G5 (2) 21W 230V

Dimensions

↔ Ø150xH1900

W1832/.. - GOTA

~230V



bollard - with stainless steel base Ø320mm - with electronic gear  
 Pollerleuchte - mit Fuß in Edelstahl Ø320mm - mit elektronischem Vorschaltgerät

Ref

W1832.5

Lamptype

⇒ T16FHT5 G5 (2) 21W 230V

Dimensions

↔ Ø150xH1460

CLEAN.200/.. - CLEAN



cleaning product for stainless steel - with stainless steel cleaner 200ml  
 Putzmittel für Edelstahl - mit Edelstahlreiniger 200ml

Ref

CLEAN.200

Dimensions

↔ Ø53xH17

CLEAN.500/.. - CLEAN



cleaning product for stainless steel - with stainless steel cleaner 500ml  
 Putzmittel für Edelstahl - mit Edelstahlreiniger 500ml

Ref

CLEAN.500

Dimensions

↔ Ø66xH24



OUTDOOR | Aluminium

<b>PICTO</b> W1663/.. P.615 	<b>PICTO</b> W1664/.. P.615 	<b>ARCADE</b> W3080A/./S P.616 	<b>W3080B/.. P.616</b> 	<b>OUTSIDER</b> W1250/./C P.617 
<b>RING RING</b> W3090.MT/.. P.618 	<b>RING RING</b> W3092.MT/.. P.618 	<b>RING RING</b> W3097.MT/.. P.619 	<b>AURORA</b> W3098.MT/.. P.619 	<b>AURORA</b> W3099.MT/.. P.619 
<b>BISTRO</b> W1339/.. P.621 	<b>BISTRO</b> W1342/.. P.621 	<b>BOB</b> W1292A/.. P.622 	<b>BOB GRANDE</b> W1292E/.. P.623 	<b>BOB GRANDE</b> W1292F/.. P.624 
<b>OTTO</b> W1082/.. P.624 	<b>OTTO FLY</b> W1079/.. P.625 	<b>OTTO</b> W1075/.. P.625 	<b>OTTO</b> W1076/.. P.625 	<b>OTTO</b> W1077/.. P.626 
<b>SPIKKIO</b> W1203/./E550 P.627 	<b>TOLEDO</b> T303R/.. P.628 	<b>TOLEDO</b> T304S/.. P.628 	<b>TOLEDO</b> W303/./S P.620 	<b>TOLEDO</b> W304/./S P.631 
<b>STONE</b> W1214/.. P.632 	<b>STONE</b> W1215/.. P.632 	<b>STONE</b> W1216/.. P.633 	<b>STONE LED</b> W1218A/.. P.632 	<b>CALIX</b> W1295E/.. P.638 
<b>BOLERO</b> W1090/./UP P.633 	<b>BOLERO</b> T109/.. P.634 	<b>BOLERO LED</b> W1096.LED/.. P.637 	<b>BOLERO LED</b> T1095.LED/.. P.637 	<b>BOLERO LED</b> T1094.LED/./.. P.638 
<b>CUBA</b> W1304/.. P.639 	<b>CUBA</b> W1305/.. P.639 	<b>CUBA</b> W1313/.. P.642 	<b>CUBA</b> W1330/.. P.642 	<b>CUBA</b> W1332/.. P.643 



**DROP**

W1081/.. P.645



**EXTER**

T1082/.. P.646



W1207/..MTP.646



W1209.35W/.. P.646



**UFO**

W1071/.. P.647



W1073/.. P.648



T1033/.. P.648



T1032/.. P.651



**UFO GRANDE**

W7070/.. P.652



T7033.45/.. P.653



T7030/.. P.655



T7039.65/.. P.655



**VITO**

W1060/.. P.656



W1061/.. P.657



**NEMO**

W1085/.. P.672



**OLYMPIA**

W301/.. P.673



**IRIS**

T100..A/.. P.657



W1052B/.. P.668



W1053F/.. P.



W1057F/.. P.671



**PIEDRO**

T302.700/.. P.673



**RYTA**

T1040.100/.. P.674



T1042.100/.. P.675



T1043.400/.. P.676



ARCADE	616
AURORA IP44	619
BISTRO	621, 622
BOB	622, 623
BOB GRANDE	623, 624
BOLERO	633, 634, 635, 636BOLERO LED 637, 638
CALIX GRANDE	638
CUBA	639-645
CUBA SPIKE	643
DROP	645, 646
EXTER	646, 647
IRIS	657 - 672
NEMO	672, 673
OLYMPIA	673
OTTO FLY	625
OTTO OUTDOOR	624, 625, 626, 627
OUTSIDER	617
PICTO - PICTO SENSOR	615
PIEDRO	673, 674
RING RING	618, 619
RYTA	674, 675, 676
SPIKKIO	627
STONE	632, 633
STONE box	633
STONE LED	632
TOLEDO	620, 628, 629, 630, 631
TOLEDO SPIKE	629, 630
UFO	647, 648, 649, 650, 651
UFO GRANDE	652, 653, 654, 655, 656
VITO	656, 657

# OUTDOOR | Aluminium | PICTO | PICTO SENSOR | PICTO | PICTO SENSOR

image of your preference should be delivered as a dxf/dwg file - LED colour cold white (CW) - other LED colours on request  
 gewünschte Figur soll in einer dxf/dwg Datei angeliefert werden - LED Farbe kalt Weiß (CW) - andere LED Farben auf Anfrage

## W1663/.. - PICTO

~230V  IP54    05.10.02 



build-up wall light  
 Wandleuchte für Aufbau

Ref  
 W1663.36.CW

### Lamptype

 led 230V . (1) 3W 230V

### Dimensions

 B120xH40xD40

 B103xH25

build-up

## W1663.SEN/.. - PICTO SENSOR

~230V  IP54    05.10.02 



build-up wall light - with twilight switch  
 Wandleuchte für Aufbau - mit Dämmerungsschalter

Ref  
 W1663.SEN.36.CW

### Lamptype

 led 230V . (1) 3W 230V

### Dimensions

 B120xH40xD40

 B103xH25

build-up

## W1664/.. - PICTO

~230V  IP54    05.10.02 



build-up wall light  
 Wandleuchte für Aufbau

Ref  
 W1664.36.CW

### Lamptype

 led 230V . (3) 3W 230V

### Dimensions

 B400xH40xD40

 B382xH25

build-up

## W1664.SEN/.. - PICTO SENSOR

~230V  IP54    05.10.02 



build-up wall light - with twilight switch  
 Wandleuchte für Aufbau - mit Dämmerungsschalter

Ref  
 W1664.SEN.36.CW

### Lamptype

 led 230V . (3) 3W 230V

### Dimensions

 B400xH40xD40

 B382xH25

build-up

**W3080A/./S - ARCADE**

~230V



build-up wall light - up or down  
Wandleuchte für Aufbau - up oder down

**Lamptype**

⊙ TC-FSE GX53 (1) 9W 230V

**Dimensions**

↔ B100xH40xD135

⌞ L60xB60

**Options**

2320.230V/.. - TYPE A : LED CASSETTE 230V 3,6W IP65

**Ref**

W3080A.32.S

W3080A.37.S

build-up

**W3080B/./DOWN - ARCADE**

~230V



house number luminaire to build up  
Hausnummernleuchte für Aufbau

**Lamptype**

⊙ TC-FSE GX53 (1) 9W 230V

**Dimensions**

↔ B100xH185xD140

⌞ L60xB60

**Options**

2320.230V/.. - TYPE A : LED CASSETTE 230V 3,6W IP65

C50/.. - NUMBER

C90/.. - NUMBER

C96/.. - NUMBER

**Ref**

W3080B.32.DOWN

W3080B.37.DOWN

build-up  
numbers or letters to order separately  
Ziffern oder Buchstaben separat bestellen

**W3080C/./S - ARCADE**

~230V



build-up wall light - up  
Wandleuchte für Aufbau - up

**Lamptype**

⊙ TC-FSE GX53 (1) 9W 230V

**Dimensions**

↔ B100xH265xD135

⌞ L60xB60

**Options**

2320.230V/.. - TYPE A : LED CASSETTE 230V 3,6W IP65

C000PUNCHED/.. - ARCADE NUMBER

**Ref**

W3080C.32.S

W3080C.37.S

build-up

**C000PUNCHED/.. - ARCADE NUMBER**

IP20  



supplement  
Supplement

**Ref**

C000PUNCHED

mention the chosen numbers or letters!  
die gewünschten Ziffern oder Buchstaben erwähnen!

W1250/.. - OUTSIDER

~12V



build-up wall light - without transformer  
Wandleuchte für Aufbau - ohne Trafo

Ref

W1250.36

Lamp type

QT12 GY6,35 (1) 50W 12V

Dimensions

B100xH100xD38

L100xB100

build-up

W1250/..C - OUTSIDER

~12V



build-up wall light - without transformer  
Wandleuchte für Aufbau - ohne Trafo

Ref

W1250.36.C

Lamp type

QT12 GY6,35 (1) 50W 12V

Dimensions

B100xH100xD38

L100xB100

build-up

W1251/.. - OUTSIDER

~230V



house number luminaire to build up - with transformer  
Hausnummernleuchte für Aufbau - mit Trafo

Ref

W1251.36

Lamp type

QT12 GY6,35 (1) 50W 12V

Dimensions

B100xH200xD70

L100xB200

Options

C50/.. - NUMBER

LA/.. - LETTER

build-up

numbers or letters to order separately  
Ziffern oder Buchstaben separat bestellen

W1252/.. - OUTSIDER

~230V



house number luminaire to build up - with transformer  
Hausnummernleuchte für Aufbau - mit Trafo

Ref

W1252.36

Lamp type

QT12 GY6,35 (1) 50W 12V

Dimensions

B120xH200xD70

L120xB200

Options

C50/.. - NUMBER

LA/.. - LETTER

build-up

numbers or letters to order separately  
Ziffern oder Buchstaben separat bestellen

**W3090.MT/.. - RING RING**

~230V



build-up wall light - LED IP68 - without twilight switch - with LED driver  
Wandleuchte für Aufbau - LED IP68 - mit Dämmerungsschalter - mit Driver LED

**Ref**  
W3090.MT.36.CW  
W3090.MT.36.B

**Lamptype**

⚙️ powered 350mA . (2) 2x1W 350mA

**Dimensions**

↔️ B125xH60xD40

⚙️ L125xB60

build-up

**W3091.MT/.. - RING RING**

~230V



house number luminaire to build up - LED IP68 - without twilight switch + frontplate - with LED driver  
Hausnummernleuchte für Aufbau - mit Dämmerungsschalter + Frontplatte - mit Driver LED

**Ref**  
W3091.MT.36.CW  
W3091.MT.36.B

**Lamptype**

⚙️ powered 350mA . (1) 2x1W 350mA

**Dimensions**

↔️ B125xH185xD42

⚙️ L185xB125

**Options**

C50/.. - NUMBER

C90/.. - NUMBER

C96/.. - NUMBER

build-up

**W3092.MT/.. - RING RING**

~230V



build-up wall light - with twilight switch + doorbell - with LED driver  
Wandleuchte für Aufbau - mit Dämmerungsschalter + Türklingel - mit Driver LED

**Ref**  
W3092.MT.36.CW  
W3092.MT.36.B

**Lamptype**

⚙️ powered 350mA . (1) 2x1W 350mA

**Dimensions**

↔️ B125xH60xD40

⚙️ L125xB60

build-up

room for nametag (not included)  
Platz für Namensschild (nicht einbegriffen)

**W3093.MT/.. - RING RING**

~230V



house number luminaire to build up - with twilight switch + doorbell + frontplate - with LED driver  
Hausnummernleuchte für Aufbau - mit Dämmerungsschalter + Türklingel + Frontplatte - mit Driver LED

**Ref**  
W3093.MT.36.CW  
W3093.MT.36.B

**Lamptype**

⚙️ powered 350mA . (1) 2x1W 350mA

**Dimensions**

↔️ B125xH185xD42

⚙️ L185xB125

**Options**

C50/.. - NUMBER

C90/.. - NUMBER

C96/.. - NUMBER

build-up

room for nametag (not included)  
Platz für Namensschild (nicht einbegriffen)

**W3094.MT/.. - RING RING**

~230V



build-up wall light - with twilight switch - with LED driver  
Wandleuchte für Aufbau - mit Dämmerungsschalter - mit Driver LED

**Ref**

W3094.MT.36.CW

W3094.MT.36.B

**Lamptype**

powered 350mA . (1) 2x1W 350mA

**Dimensions**

B125xH60xD40

L125xB60

build-up

**W3097.MT/.. - RING RING**

~230V



house number luminaire to build up - with twilight switch + front plate - with LED driver  
Hausnummernleuchte für Aufbau - mit Dämmerungsschalter + Frontplatte - mit Driver LED

**Ref**

W3097.MT.36.CW

W3097.MT.36.B

**Lamptype**

powered 350mA . (1) 2x1W 350mA

**Dimensions**

B125xH185xD42

L185xB125

**Options**

C50/.. - NUMBER

C90/.. - NUMBER

C96/.. - NUMBER

build-up

**W3098.MT/.. - AURORA IP44**

=20mA/3V



build-up wall light - on solar energy + 4 positions switch + LED + build-in twilight switch - without LED driver  
Wandleuchte für Aufbau - auf Solarenergie + 4 Standenschalter + LED + eingebauter Dämmerungsschalter - ohne Driver LED

**Ref**

W3098.MT.36.CW

W3098.MT.36.B

**Lamptype**

led 5mm . (1) 0,06W 20mA/3V

**Dimensions**

B120xH40xD107

L120xB40

build-up

to be preset 4 to 6h - with rechargeable battery  
1300mA - no current supply needed  
4 bis 6 Stunden voreinstellbar - mit nachladbarer  
Batterie 1300mA - keine Stromzuführung nötig

**W3099.MT/.. - AURORA IP44**

=20mA/3V



house number luminaire to build up - on solar energy + 4 positions switch + LED + build-in twilight switch - without LED driver  
Hausnummernleuchte für Aufbau - auf Solarenergie + 4 Standenschalter + LED + eingebauter Dämmerungsschalter - ohne Driver LED

**Ref**

W3099.MT.36.CW

W3099.MT.36.B

**Lamptype**

led 5mm . (1) 0,06W 20mA/3V

**Dimensions**

B125xH185xD109

L185xB125

**Options**

C50/.. - NUMBER

C90/.. - NUMBER

C96/.. - NUMBER

build-up

to be preset 4 to 6h - with rechargeable battery  
1300mA - no current supply needed  
4 bis 6 Stunden voreinstellbar - mit nachladbarer  
Batterie 1300mA - keine Stromzuführung nötig

**W303/..R - TOLEDO**

~230V  IP44    0,5 m  05.10.02 



house number luminaire to build up  
Hausnummernleuchte für Aufbau

**Ref**

- W303.5.R
- W303.5B.R
- W303.21B.R
- W303.32.R
- W303.37.R

**Lamptype**

⊙ TC-FSE GX53 (1) 9W 230V

**Dimensions**

↔ B100xH185xD155

⤴ B100xH185

**Options**

- 2320.230V/.. - TYPE A : LED CASSETTE 230V 3,6W IP65
- 2320.24V/.. - TYPE B : LED CASSETTE 24V-DC 3,6W IP65
- C50/.. - NUMBER
- LA/.. - LETTER

*build-up  
numbers or letters to order separately  
Ziffern oder Buchstaben separat bestellen*

**W303/..S - TOLEDO**

~230V  IP44    0,5 m  05.10.02 



house number luminaire to build up  
Hausnummernleuchte für Aufbau

**Ref**

- W303.5.S
- W303.5B.S
- W303.21B.S
- W303.32.S
- W303.37.S

**Lamptype**

⊙ TC-FSE GX53 (1) 9W 230V

**Dimensions**

↔ B100xH185xD155

⤴ B100xH185

**Options**

- 2320.230V/.. - TYPE A : LED CASSETTE 230V 3,6W IP65
- 2320.24V/.. - TYPE B : LED CASSETTE 24V-DC 3,6W IP65
- C50/.. - NUMBER
- LA/.. - LETTER

*build-up  
numbers or letters to order separately  
Ziffern oder Buchstaben separat bestellen*

**C50/.. - NUMBER**

IP20    0,0375 



houzenumber - numbers 0-9 or letters A-B-C H50mm alu -  
ano + painted finish  
Hausnummer - Ziffern 0-9 oder Buchstaben A-B-C H50mm  
Alu - anodisiert + lackiert

**Ref**

- C50.32
- C50.37

**Dimensions**

↔ H50

**Options**

- arcade
- aurora
- outsider
- ring ring
- toledo W303

*mention the chosen numbers or letters!  
die gewünschten Ziffern oder Buchstaben erwähnen!*

**L/.. - LETTER**

IP20  

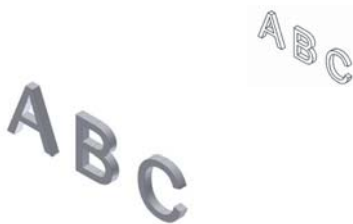

houzenumber - letters A-B-C-D alu ano + painted finish  
Hausnummer - Buchstaben A-B-C-D Alu anodisiert + lackiert

**Dimensions**

↔ H50

Colour	LA/..	LB/..	LC/..	LD/..
	32			
	37			



W1339/.. - BISTRO

~230V



build-up wall light - chrome reflector  
Wandleuchte für Aufbau - Chrom Reflektor

Ref

W1339.36

Lamp type

QT14 G9 (1) 40W 230V

Dimensions

B100xH100xD150 40° reflector

L100xB100

build-up

W1340/.. - BISTRO

~230V

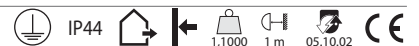

build-up wall light - alu reflector  
Wandleuchte für Aufbau - Alu Reflektor

Ref

W1340.36

Lamp type

QT14 G9 (1) 40W 230V

Dimensions

B100xH100xD150 40° reflector

L100xB100

build-up

W1341/.. - BISTRO

~230V

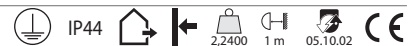

house number luminaire to build up - frontplate in stainless steel  
Hausnummernleuchte für Aufbau - Frontplatte in Edelstahl

Ref

W1341.36

Lamp type

QT14 G9 (1) 40W 230V

Dimensions

B150xH300xD140 40° reflector

L250xB100

Options

C90/.. - NUMBER

C96/.. - NUMBER

build-up  
house number to order separately  
Hausnummer separat bestellen

W1342/.. - BISTRO

~230V

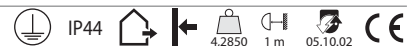

house number luminaire to build up - frontplate in stainless steel  
Hausnummernleuchte für Aufbau - Frontplatte in Edelstahl

Ref

W1342.36

Lamp type

QT14 G9 (2) 40W 230V

Dimensions

B300xH300xD140 40° reflector

L250xB250

Options

C90/.. - NUMBER

C96/.. - NUMBER

build-up  
house number to order separately  
Hausnummer separat bestellen

W1343/.. - BISTRO

~230V



house number luminaire to build up - frontplate in stainless steel  
Hausnummernleuchte für Aufbau - Frontplatte in Edelstahl

Ref  
W1343.36

Lamptype

☑ QT14 G9 (2) 40W 230V

Dimensions

↔ B300xH550xD140 ∟ 40° reflector

⚡ L495xB245

Options

C90/.. - NUMBER  
C96/.. - NUMBER

build-up  
house number to order separately  
Hausnummer separat bestellen

C90/.. - NUMBER



house number - numbers 0-9 or letters A-B-C H90mm  
stainless steel + painted finish  
Hausnummer - Ziffern 0-9 oder Buchstaben A-B-C H90mm  
Edelstahl + lackiert

Ref  
C90.32  
C90.37

Dimensions

↔ H90

Options

arcade  
aurora  
bistro  
ring ring

mention the chosen numbers or letters!  
die gewünschten Ziffern oder Buchstaben erwähnen!

C96/.. - NUMBER



house number - numbers 0-9 or letters A-B-C H96mm alu -  
ano + painted finish  
Hausnummer - Ziffern 0-9 oder Buchstaben H96mm Alu -  
anodisiert + lackiert

Ref  
C96.32  
C96.37

Dimensions

↔ H96

Options

arcade  
aurora  
bistro  
ring ring

mention the chosen numbers or letters!  
die gewünschten Ziffern oder Buchstaben erwähnen!

W1292A/.. - BOB

~230V

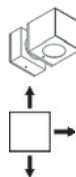

build-up wall light - up-down-front  
Wandleuchte für Aufbau - up-down-front

Ref  
W1292A.36

Lamptype

☑ QT14 G9 (1) 40W 230V

Dimensions

↔ B60xH60xD117

⚡ L60xB60

build-up

**W1292B/.. - BOB**

~230V

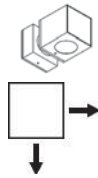

build-up wall light - down-front  
Wandleuchte für Aufbau - down-front

Ref  
W1292B.36

**Lamptype**

QT14 G9 (1) 40W 230V

**Dimensions**

B60xH60xD117

L60xB60

build-up

**W1292C/.. - BOB**

~230V

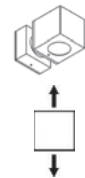
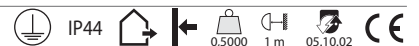

build-up wall light - up-down  
Wandleuchte für Aufbau - up-down

Ref  
W1292C.36

**Lamptype**

QT14 G9 (1) 40W 230V

**Dimensions**

B60xH60xD117

L60xB60

build-up

**W1292D/.. - BOB**

~230V

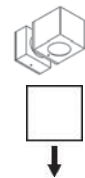
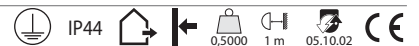

build-up wall light - down  
Wandleuchte für Aufbau - down

Ref  
W1292D.36

**Lamptype**

QT14 G9 (1) 40W 230V

**Dimensions**

B60xH60xD117

L60xB60

build-up

**W1292E/.. - BOB GRANDE**

~230V

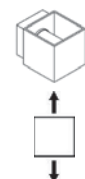

build-up wall light - with opal white glass  
Wandleuchte für Aufbau - mit opalweißem Glas

Ref  
W1292E.32M  
W1292E.36

**Lamptype**

TC-HSE E27 (1) 11W 230V

**Dimensions**

B120xH120xD154

build-up  
up & down

**W1292F/.. - BOB GRANDE**

~230V



build-up ceiling light - with opal white glass  
Aufbau Deckenleuchte - mit opalweißem Glas

**Lamptype**

☛ TC-HSE E27 (1) 15W 230V

**Dimensions**

↔ L120xB120xH154

**Ref**

W1292F.32M

W1292F.36

build-up  
down

**W1292G/.. - BOB GRANDE**

~230V



build-up ceiling light - with opal white glass  
Aufbau Deckenleuchte - mit opalweißem Glas

**Lamptype**

☛ TC-HSE E27 (1) 20W 230V

**Dimensions**

↔ L120xB120xH174

**Ref**

W1292G.32M

W1292G.36

build-up

**W1082/.. - OTTO OUTDOOR**

~230V

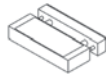
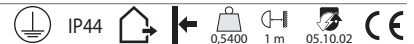

build-up wall light - up  
Wandleuchte für Aufbau - up

**Lamptype**

☛ QT-DE 12 114,1mm R7s (1) 150W 230V

**Dimensions**

↔ B220xH40xD143

⊣ L220xB40

**Ref**

W1082.31

W1082.32

W1082.37

build-up  
do not screw on too tightly  
nicht zu fest verschrauben

**W1083/.. - OTTO OUTDOOR**

~230V

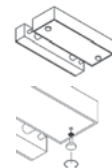
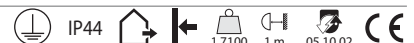

build-up wall light - down  
Wandleuchte für Aufbau - down

**Lamptype**

☛ QT-DE 12 114,1mm R7s (1) 150W 230V

**Dimensions**

↔ B220xH40xD143

⊣ L220xB40

**Ref**

W1083.31

W1083.32

W1083.37

build-up  
do not screw on too tightly  
nicht zu fest verschrauben

**W1084/.. - OTTO OUTDOOR**

~230V



build-up wall light - up-down  
Wandleuchte für Aufbau - up-down

**Ref**

W1084.31  
W1084.32  
W1084.37

**Lamp type**

— QT-DE 12 114,1mm R7s (1) 150W 230V

**Dimensions**

↔ B220xH40xD143  
⌞ L220xB40

*build-up*  
do not screw on too tightly  
nicht zu fest verschrauben

**W1079/.. - OTTO FLY**

~230V

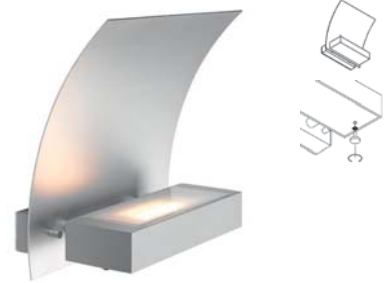
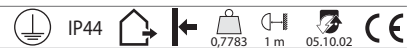

build-up wall light - up-down  
Wandleuchte für Aufbau - up-down

**Ref**

W1079.31  
W1079.32  
W1079.37

**Lamp type**

— QT-DE 12 114,1mm R7s (1) 150W 230V

**Dimensions**

↔ B260xH255xD145  
⌞ L220xB40

*build-up*  
do not screw on too tightly  
nicht zu fest verschrauben

**W1075/.. - OTTO OUTDOOR**

~230V



build-up wall light - down - with electronic gear  
Wandleuchte für Aufbau - down - mit elektronischem  
Vorschaltgerät

**Ref**

W1075.31  
W1075.32  
W1075.37

**Lamp type**

← TC-DEL G24q3 (2) 26W 230V

**Dimensions**

↔ B246xH50xD225  
⌞ L245xB50

*build-up*  
do not screw on too tightly  
nicht zu fest verschrauben

**W1076/.. - OTTO OUTDOOR**

~230V



build-up wall light - up-down - with electronic gear  
Wandleuchte für Aufbau - up-down - mit elektronischem  
Vorschaltgerät

**Ref**

W1076.31  
W1076.32  
W1076.37

**Lamp type**

← TC-DEL G24q3 (1) 26W 230V

**Dimensions**

↔ B245xH50xD162  
⌞ L245xB50

*build-up*  
do not screw on too tightly  
nicht zu fest verschrauben

**W1076.2/.. - OTTO OUTDOOR**

~230V



build-up wall light - up-down - with electronic gear  
Wandleuchte für Aufbau - up-down - mit elektronischem  
Vorschaltgerät

**Ref**

- W1076.2.31
- W1076.2.32
- W1076.2.37

**Lamptype**

← TC-DEL G24q3 (2) 26W 230V

**Dimensions**

↔ B245xH50xD162

⌞ L245xB50

*build-up  
do not screw on too tightly  
nicht zu fest verschrauben*

**W1077./.. - OTTO OUTDOOR**

~230V



build-up wall light - down - with electronic gear  
Wandleuchte für Aufbau - down - mit elektronischem  
Vorschaltgerät

**Ref**

- W1077.31
- W1077.32
- W1077.37

**Lamptype**

← TC-DEL G24q3 (1) 26W 230V

**Dimensions**

↔ B245xH50xD162

⌞ L245xB50

*build-up  
do not screw on too tightly  
nicht zu fest verschrauben*

**W1077.2/.. - OTTO OUTDOOR**

~230V



build-up wall light - down - with electronic gear  
Wandleuchte für Aufbau - down - mit elektronischem  
Vorschaltgerät

**Ref**

- W1077.2.31
- W1077.2.32
- W1077.2.37

**Lamptype**

← TC-DEL G24q3 (2) 26W 230V

**Dimensions**

↔ B245xH50xD162

⌞ L245xB50

*build-up  
do not screw on too tightly  
nicht zu fest verschrauben*

**W1078./.. - OTTO OUTDOOR**

~230V



build-up wall light - up - with electronic gear  
Wandleuchte für Aufbau - up - mit elektronischem  
Vorschaltgerät

**Ref**

- W1078.31
- W1078.32
- W1078.37

**Lamptype**

← TC-DEL G24q3 (1) 26W 230V

**Dimensions**

↔ B245xH50xD162

⌞ L245xB50

*build-up*

**W1078.2/.. - OTTO OUTDOOR**

~230V   IP44    1 m  05.10.50 



build-up wall light - up - with electronic gear  
Wandleuchte für Aufbau - up - mit elektronischem  
Vorschaltgerät

**Ref**

W1078.2.31

W1078.2.32

W1078.2.37

**Lamptype**

← TC-DEL G24q3 (2) 26W 230V

**Dimensions**

↔ B245xH50xD162

↕ L245xB50

build-up

**W1203../ES50 - SPIKKIO**

~230V  IP44    0,5100  1 m  05.10.02 

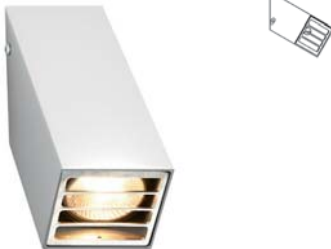

build-up wall light  
Wandleuchte für Aufbau

**Ref**

W1203.36.ES50

**Lamptype**

← QPAR 51 GU10 (1) 50W 230V

**Dimensions**

↔ B60xH145xD105

↕ L60xB85

build-up

**W1204../ES50 - SPIKKIO**

~230V  IP44    1 m  05.10.02 



build-up wall light  
Wandleuchte für Aufbau

**Ref**

W1204.36.ES50

**Lamptype**

← QPAR 51 GU10 (2) 50W 230V

**Dimensions**

↔ B165xH150xD125

↕ L165xB100

build-up

**W1205../ES50 - SPIKKIO**

~230V  IP44    1 m  05.10.02 



ceiling light - down  
Deckenleuchte - down

**Ref**

W1205.36.ES50

**Lamptype**

← QPAR 51 GU10 (1) 50W 230V

**Dimensions**

↔ B60xH60xD140

↕ L60xB60

build-up

T303R/.. - TOLEDO

~230V



IP44



0,7300

0,5 m

05.10.02



bollard  
Pollerleuchte

**Lamptype**

⌀ TC-FSE GX53 (1) 9W 230V

**Dimensions**

↔ L100xB40

**Options**

2320.230V/.. - TYPE A : LED CASSETTE 230V 3,6W IP65

2320.24V/.. - TYPE B : LED CASSETTE 24V-DC 3,6W IP65

T305/.. - TOLEDO SPIKE

Colour	T303.150R/.. H 150	T303.400R/.. H 400	T303.600R/.. H 600
5			
5B			
5BB			
21B			
32			
37			

T303S/.. - TOLEDO

~230V



IP44



0,5 m

05.10.02



bollard  
Pollerleuchte

**Lamptype**

⌀ TC-FSE GX53 (2) 9W 230V

**Dimensions**

↔ L100xB40

**Options**

2320.230V/.. - TYPE A : LED CASSETTE 230V 3,6W IP65

2320.24V/.. - TYPE B : LED CASSETTE 24V-DC 3,6W IP65

T305/.. - TOLEDO SPIKE

Colour	T303.150S/.. H 150	T303.400S/.. H 400	T303.600S/.. H 600
5			
5B			
5BB			
21B			
32			
37			



T305/.. - TOLEDO SPIKE

IP20   0,4850 



spike  
Erdspieß

Ref  
T305

**Dimensions**

↔ L100xB40xH250

T304R/.. - TOLEDO

~230V  IP44   0,5 m  05.10.02 



bollard  
Pollerleuchte

**Lamptype**

⌀ TC-FSE GX53 (2) 9W 230V

**Dimensions**

↔ L100xB100

**Options**

2320.230V/.. - TYPE A : LED CASSETTE 230V 3,6W IP65

2320.24V/.. - TYPE B : LED CASSETTE 24V-DC 3,6W IP65

T307/.. - TOLEDO SPIKE

Colour	T304.150R/..	T304.400R/..	T304.600R/..
	H 150	H 400	H 600
5			
5B			
21B			
32			
37			

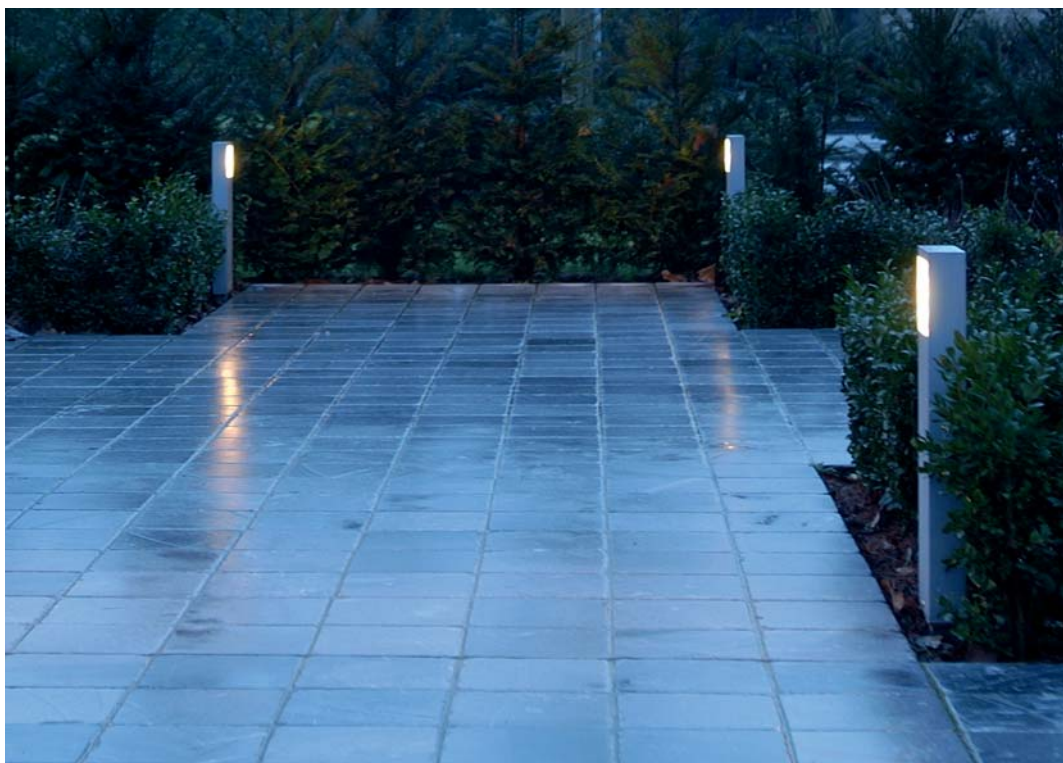

Aluminium outdoor

T304S/.. - TOLEDO

~230V  IP44   0,5 m  05.10.02 



bollard  
Pollerleuchte

**Lamptype**

⌀ TC-FSE GX53 (2) 9W 230V

**Dimensions**

↔ L100xB100

**Options**

2320.230V/.. - TYPE A : LED CASSETTE 230V 3,6W IP65

2320.24V/.. - TYPE B : LED CASSETTE 24V-DC 3,6W IP65

T307/.. - TOLEDO SPIKE

Colour	T304.150S/..	T304.400S/..	T304.600S/..
	H 150	H 400	H 600
5			
5B			
21B			
32			
37			

T307/.. - TOLEDO SPIKE

IP20   1,0500  



spike  
Erdspieß

**Ref**

T307

**Dimensions**

↔ L100xB100xH250

W304/..R - TOLEDO

~230V  IP44   0,5 m  05.10.02 



build-up wall light  
Wandleuchte für Aufbau

**Ref**

W304.5.R  
W304.5B.R  
W304.21B.R  
W304.32.R  
W304.37.R

**Lamptype**

⌀ TC-FSE GX53 (1) 9W 230V

**Dimensions**

↔ B100xH255xD72

⊣ B130xH100

**Options**

2320.230V/.. - TYPE A : LED CASSETTE 230V 3,6W IP65

2320.24V/.. - TYPE B : LED CASSETTE 24V-DC 3,6W IP65

build-up

W304/..S - TOLEDO

~230V IP44 0,5 m 05.10.02 CE



build-up wall light  
Wandleuchte für Aufbau

Ref

- W304.5.S
- W304.5B.S
- W304.21B.S
- W304.32.S
- W304.37.S

Lamptype

TC-FSE GX53 (1) 9W 230V

Dimensions

B100xH255xD72

B130xH100

Options

- 2320.230V/.. - TYPE A : LED CASSETTE 230V 3,6W IP65
- 2320.24V/.. - TYPE B : LED CASSETTE 24V-DC 3,6W IP65

build-up

W306/..R - TOLEDO

~230V IP44 0,5 m 05.10.02 CE



build-up wall light  
Wandleuchte für Aufbau

Ref

- W306.5.R
- W306.5B.R
- W306.21B.R
- W306.32.R
- W306.37.R

Lamptype

TC-FSE GX53 (1) 9W 230V

Dimensions

B100xH150xD42

B100xH150

Options

- 2320.230V/.. - TYPE A : LED CASSETTE 230V 3,6W IP65
- 2320.24V/.. - TYPE B : LED CASSETTE 24V-DC 3,6W IP65

build-up

W306/..S - TOLEDO

~230V IP44 0,5750 0,5 m 05.10.02 CE



build-up wall light  
Wandleuchte für Aufbau

Ref

- W306.5.S
- W306.5B.S
- W306.21B.S
- W306.32.S
- W306.37.S

Lamptype

TC-FSE GX53 (1) 9W 230V

Dimensions

B100xH150xD42

B100xH150

Options

- 2320.230V/.. - TYPE A : LED CASSETTE 230V 3,6W IP65
- 2320.24V/.. - TYPE B : LED CASSETTE 24V-DC 3,6W IP65

build-up

# OUTDOOR | Aluminium | STONE LED | STONE

LED colour: cold white (CW) - other LED colours on request

LED Farbe: kalt Weiß (CW) - andere LED Farben auf Anfrage

## W1218A/.. - STONE LED

~230V



build-in wall light  
Einbau Wandleuchte

### Lamptype

led 230V . (1) 3W 230V

### Dimensions

B60xH150xD55

130x53 56

### Ref

W1218A.36.CW

W1218A.37.CW

*build-in*  
for wooden and aluminium profiles  
für Holz- und Aluminiumprofile

## W1218B/.. - STONE LED

=24V-DC



build-in wall light - without transformer  
Einbau Wandleuchte - ohne Trafo

### Lamptype

led 24V-DC . (1) 3W 24V-DC

### Dimensions

B60xH150xD55

130x53 56

### Ref

W1218B.36.CW

W1218B.37.CW

*build-in*  
for wooden and aluminium profiles  
für Holz- und Aluminiumprofile

## W1214/.. - STONE

~230V

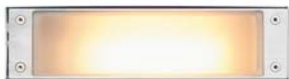

build-in wall light - no build-in box required - with magnetic gear  
Einbau Wandleuchte - Einbaudose nicht notwendig - mit magnetischem Vorschaltgerät

### Lamptype

TC-S G23 (1) 9W 230V

### Dimensions

B240xH65xD70

244x67 90

### Ref

W1214.5

*build-in*

## W1215/.. - STONE

~230V



build-in wall light - with magnetic gear  
Einbau Wandleuchte - mit magnetischem Vorschaltgerät

### Lamptype

TC-S G23 (1) 9W 230V

### Dimensions

B260xH85xD73

246x67 101

### Ref

W1215.5

### Options

W1217B/.. - STONE box

*build-in*

**W1216/.. - STONE**

~230V   S2 IP44    1,6800  0,5 m  05.10.50 



build-in wall light - with magnetic gear  
Einbau Wandleuchte - mit magnetischem Vorschaltgerät

Ref  
W1216.5

**Lamptype**

TC-S G23 (1) 9W 230V

**Dimensions**

B260xH85xD73

246x67 101

**Options**

W1217B/.. - STONE box



build-in

**W1217B/.. - STONE box**

IP20    0,2000 



build-in box - for W1216 & W1215  
Einbaudose - für W1216 & W1215

Ref  
W1217B

**Dimensions**

B250xH70xD100

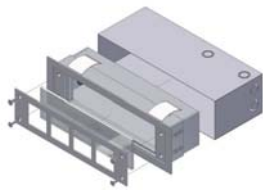

**W1090/..UP - BOLERO**

~230V  IP44    4,9460  1 m  05.10.02 



build-up wall light - up  
Wandleuchte für Aufbau - up

Ref  
W1090.36.UP

**Lamptype**

QT14 G9 (1) 40W 230V

or CFL G9 (1) 7W 230V

**Dimensions**

B55xH130xD105

L56xB40



build-up

**W1091/..UP - BOLERO**

~230V  IP44    11,3460  1 m  05.10.02 



build-up wall light - up  
Wandleuchte für Aufbau - up

Ref  
W1091.36.UP

**Lamptype**

QT14 G9 (2) 40W 230V

or CFL G9 (2) 7W 230V

**Dimensions**

B150xH135xD120

L150xB50



build-up

**W1092/.. - BOLERO**

~230V  IP44   0,6200  1 m  05.10.02 





build-up wall light - up-down  
Wandleuchte für Aufbau - up-down

Ref  
W1092.36

**Lamptype**

 QT14 G9 (2) 40W 230V  
or  CFL G9 (2) 7W 230V

**Dimensions**

 B55xH217xD105  
 L56xB40

build-up

**T109../.. - BOLERO**

~230V  IP66   0,9650  1 m  05.10.02 



bollard  
Pollerleuchte

**Lamptype**

 QT14 G9 (1) 40W 230V  
or  CFL G9 (1) 7W 230V

**Dimensions**

 Ø90

**Options**

T1021/.. - IRIS - CUBA SPIKE

Colour	T1096/..	T1097/..	T1098/..	T1099/..	T1100/..
	H 160	H 460	H 660	H 860	H 1060
	36				

**W1094/..UP - BOLERO**

~230V  IP44   6,3980  0,5 m  05.10.02 



build-up wall light - up  
Wandleuchte für Aufbau - up

Ref  
W1094.36.UP

**Lamptype**

 mini lynx longlife E27 (1) 11W 230V

**Dimensions**

 B55xH180xD105  
 L56xB40

build-up

**W1095/..UP - BOLERO**

~230V  IP44   0,5 m  05.10.02 





build-up wall light - up  
Wandleuchte für Aufbau - up

Ref  
W1095.36.UP

**Lamptype**

 mini lynx longlife E27 (2) 11W 230V

**Dimensions**

 B150xH185xD118  
 L150xB50

build-up

**W1098/./DOWN - BOLERO**

~230V  IP44    0,4150  1 m  05.10.02 



build-up wall light - down  
Wandleuchte für Aufbau - down

Ref  
W1098.36.DOWN

**Lamptype**

 QPAR 51 GU10 (1) 35W 230V

**Dimensions**

 B55xH85xD105

 L56xB40

**build-up**  
also available in 12V without transformer  
auch 12V ohne Trafo verfügbar auf Anfrage

**W1098/./UP - BOLERO**

~230V  IP44    3,6900  1 m  05.10.02 



build-up wall light - up  
Wandleuchte für Aufbau - up

Ref  
W1098.36.UP

**Lamptype**

 QPAR 51 GU10 (1) 35W 230V

**Dimensions**

 B55xH85xD105

 L56xB40

**build-up**  
also available in 12V without transformer  
auch 12V ohne Trafo verfügbar auf Anfrage

**W1099/./DOWN - BOLERO**

~230V  IP44    10,3820  1 m  05.10.02 



build-up wall light - down  
Wandleuchte für Aufbau - down

Ref  
W1099.36.DOWN

**Lamptype**

 QPAR 51 GU10 (2) 35W 230V

**Dimensions**

 B150xH90xD120

 L150xB50

**build-up**  
also available in 12V without transformer  
auch 12V ohne Trafo verfügbar auf Anfrage

**W1099/./UP - BOLERO**

~230V  IP44    1 m  05.10.02 



build-up wall light - up  
Wandleuchte für Aufbau - up

Ref  
W1099.36.UP

**Lamptype**

 QPAR 51 GU10 (2) 35W 230V

**Dimensions**

 B150xH90xD120

 L150xB50

**build-up**  
also available in 12V without transformer  
auch 12V ohne Trafo verfügbar auf Anfrage

W1200/.. - BOLERO

~230V



IP44



0,4700

1 m

05.10.02



build-up wall light - up & down  
Wandleuchte für Aufbau - up & down

Ref

W1200.36

Lamptype

QPAR 51 GU10 (2) 35W

230V

Dimensions

B55xH130xD105

L56xB40



*build-up*  
also available in 12V without transformer  
auch 12V ohne Trafo verfügbar auf Anfrage

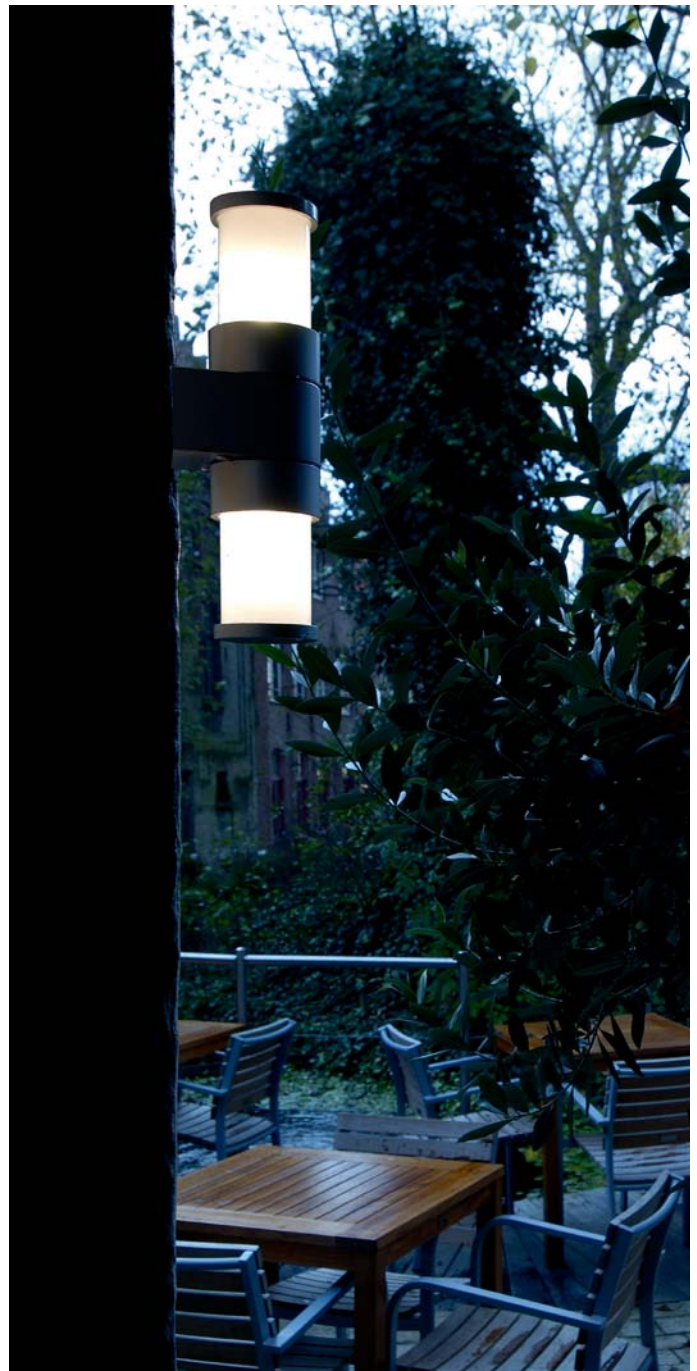



LED colours: cold white (CW) warm white (WW) or natural white (NW) - other LED colours on request  
 LED Farben: kalt Weiß (CW) warm Weiß (WW) oder naturell Weiß (NW) - andere LED Farben auf Anfrage

**W1096.LED/.. - BOLERO LED**

~230V IP54 0.5 m 05.10.02



build-up wall light - down  
 Wandleuchte für Aufbau - down

**Lamptype**

led 230V . (1) 3W 230V

**Dimensions**

B60xH40xD100

**Ref**

- W1096.LED.34.CW
- W1096.LED.34.NW
- W1096.LED.34.WW
- W1096.LED.36.CW
- W1096.LED.36.NW
- W1096.LED.36.WW
- W1096.LED.37.CW
- W1096.LED.37.NW
- W1096.LED.37.WW

build-up

**W1097.LED/.. - BOLERO LED**

~230V IP54 0.5 m 05.10.02



build-up wall light - down sloping  
 Wandleuchte für Aufbau - down schräg

**Lamptype**

led 230V . (1) 3W 230V

**Dimensions**

B60xH40xD110

**Ref**

- W1097.LED.34.CW
- W1097.LED.34.NW
- W1097.LED.34.WW
- W1097.LED.36.CW
- W1097.LED.36.NW
- W1097.LED.36.WW
- W1097.LED.37.CW
- W1097.LED.37.NW
- W1097.LED.37.WW

build-up

**T1095.LED/.. - BOLERO LED**

~230V IP54 0.9650 1 m 05.10.02



bollard  
 Pollerleuchte

**Lamptype**

led 230V . (1) 3W 230V

**Dimensions**

L60xB40xH120

**Ref**

- T1095.LED.34.CW
- T1095.LED.34.WW
- T1095.LED.34.B
- T1095.LED.36.CW
- T1095.LED.36.WW
- T1095.LED.36.B
- T1095.LED.37.CW
- T1095.LED.37.WW
- T1095.LED.37.B

build-up

# OUTDOOR | Aluminium | BOLERO | CALIX GRANDE | CALIX box

LED colours: cold white (CW) warm white (WW) or natural white (NW) - other LED colours on request  
 LED Farben: kalt Weiß (CW) warm Weiß (WW) oder naturell Weiß (NW) - andere LED Farben auf Anfrage

## T1094.LED/./.. - BOLERO

~230V  IP54   0,9650  1 m  05.10.02 



bollard  
 Pollerleuchte

### Lamptype

 led 230V . (1) 3W 230V

### Dimensions

 L60xB40

 L100xB100

Colour	T1094. LED.200/..	T1094. LED.400/..	T1094. LED.600/..
	H 200	H 400	H 600
34.CW			
34.WW			
34.B			
36.CW			
36.WW			
36.B			
37.CW			
37.WW			
37.B			

## W1295E/.. - CALIX GRANDE

~230V  IP44   0,2940  1 m  05.10.02 



semi build-in and build-up wall light - standard sandblasted white glass  
 Halbeinbau und Halbaufbau Wandleuchte - standard weiß sandgestrahltes Glas

### Ref

W1295E.36

### Lamptype

 QT14 G9 (1) 25W 230V

### Dimensions

 Ø80xH45

 Ø32  R 32

### Options

1295G/.. - CALIX box

2320.230V/.. - TYPE A : LED CASSETTE 230V 3,6W IP65

2320.24V/.. - TYPE B : LED CASSETTE 24V-DC 3,6W IP65

semi build in/up

## 1295G/.. - CALIX box

IP20   0,0750 



build-in box - box type E  
 Einbaudose - Einbaudose Typ E

### Ref

1295G

### Dimensions

 Ø72

 Ø68x72

build-in



W1302/.. - CUBA

~12V III   IP44    0,6765  0,5 m  05.10.02 



build-up wall light - with glass - without transformer  
Wandleuchte für Aufbau - mit Glas - ohne Trafo

**Lamptype**  
 <math>\sphericalangle</math> QR-CB 51 GU5,3/GX5,3 (1) 50W 12V

**Dimensions**  
 $\rightarrow$  Ø60xH80xD105  
 $\uparrow$  Ø55xH30

**Options**  
 T1332/.. - CUBA SPIKE

**Ref**  
 W1302.20  
 W1302.30  
 W1302.31  
 W1302.32  
 W1302.37  
 W1302.50

build-up

W1304/.. - CUBA

~12V III  IP44    0,8338  0,5 m  05.10.02 



build-up wall light - directional - with glass - without transformer  
Wandleuchte für Aufbau - schwenkbar - mit Glas - ohne Trafo

**Lamptype**  
 <math>\sphericalangle</math> QR-CB 51 GU5,3/GX5,3 (1) 50W 12V

**Dimensions**  
 $\rightarrow$  Ø60xH80xD160  
 $\uparrow$  Ø55xH30

**Options**  
 T1332/.. - CUBA SPIKE

**Ref**  
 W1304.20  
 W1304.30  
 W1304.31  
 W1304.32  
 W1304.37  
 W1304.50

build-up

W1305/.. - CUBA

~12V III  IP44    0,5 m  05.10.02 



build-up wall light - with glass - without transformer  
Wandleuchte für Aufbau - mit Glas - ohne Trafo

**Lamptype**  
 <math>\sphericalangle</math> QR-CB 51 GU5,3/GX5,3 (1) 50W 12V

**Dimensions**  
 $\rightarrow$  Ø60xH300xD530  
 $\uparrow$  Ø55xH30

**Ref**  
 W1305.30  
 W1305.31  
 W1305.32  
 W1305.37

build-up

W1306/.. - CUBA

~230V   IP44    0,9999  0,5 m  05.10.02 



build-up wall light - with glass - with transformer  
Wandleuchte für Aufbau - mit Glas - mit Trafo

**Lamptype**  
 <math>\sphericalangle</math> QR-CB 51 GU5,3/GX5,3 (1) 50W 12V

**Dimensions**  
 $\rightarrow$  B60xH95xD143  
 $\uparrow$  B60xH95xD55

**Ref**  
 W1306.20  
 W1306.30  
 W1306.31  
 W1306.32  
 W1306.37  
 W1306.50

build-up  
60VA

W1307/.. - CUBA

~230V   IP44    1,5659  0,5 m  05.10.02  



build-up wall light - with glass - with transformer  
Wandleuchte für Aufbau - mit Glas - mit Trafo

Ref

Lamptype

◁ QR-CB 51 GU5,3/GX5,3 (2) 50W 12V

Dimensions

↔ B60xH175xD130

↕ L40xB120

W1307.20  
W1307.30  
W1307.31  
W1307.32  
W1307.37  
W1307.50

build-up  
105VA

W1308/.. - CUBA

~230V   IP44    1,8558  0,5 m  05.10.02  



build-up wall light - with glass - with transformer  
Wandleuchte für Aufbau - mit Glas - mit Trafo

Ref

Lamptype

◁ QR-CB 51 GU5,3/GX5,3 (2) 50W 12V

Dimensions

↔ B200xH80xD130

↕ L200xB60

W1308.20  
W1308.30  
W1308.31  
W1308.32  
W1308.37  
W1308.50

build-up

W1309/.. - CUBA

~230V   IP44    0,9513  0,5 m  05.10.02  



build-up wall light - directional - with glass - with transformer  
Wandleuchte für Aufbau - schwenkbar - mit Glas - mit Trafo

Ref

Lamptype

◁ QR-CB 51 GU5,3/GX5,3 (1) 50W 12V

Dimensions

↔ B60xH90xD160

↕ L60xB95

W1309.20  
W1309.30  
W1309.31  
W1309.32  
W1309.37  
W1309.50

build-up  
60VA

W1310/.. - CUBA

~230V   IP44    1,7255  0,5 m  05.10.02  



build-up wall light - directional - with glass - with transformer  
Wandleuchte für Aufbau - schwenkbar - mit Glas - mit Trafo

Ref

Lamptype

◁ QR-CB 51 GU5,3/GX5,3 (2) 50W 12V

Dimensions

↔ B120xH180xD150

↕ L60xB120

W1310.20  
W1310.30  
W1310.31  
W1310.32  
W1310.37  
W1310.50

build-up  
105VA

W1311/.. - CUBA

~230V   IP44    4,4102  0,5 m  05.10.02 



build-up wall light - directional - with glass - with transformer  
Wandleuchte für Aufbau - schwenkbar - mit Glas - mit Trafo

**Lamptype**  
 <math>\angle</math> QR-CB 51 GU5,3/GX5,3 (2) 50W 12V

**Dimensions**  
 <math>\longleftrightarrow</math> B200xH110xD165  
 <math>\updownarrow</math> L200xB60

**Ref**  
 W1311.20  
 W1311.30  
 W1311.31  
 W1311.32  
 W1311.37  
 W1311.50

build-up  
105VA

W1312/.. - CUBA

~230V   IP44    1,3418  0,5 m  05.10.02 



build-up wall light - directional - with glass - with transformer  
Wandleuchte für Aufbau - schwenkbar - mit Glas - mit Trafo

**Lamptype**  
 <math>\angle</math> QR-CB 51 GU5,3/GX5,3 (1) 50W 12V

**Dimensions**  
 <math>\longleftrightarrow</math> Ø90xL660

**Options**  
 T1021/.. - IRIS - CUBA SPIKE

**Ref**  
 W1312.32  
 W1312.37

build-up  
60VA

W1313/.. - CUBA

~230V   IP54    1,6539  0,5 m  05.10.02 



bollard with spike - directional - with glass - with transformer  
Pollerleuchte mit Erdspieß - schwenkbar - mit Glas - mit Trafo

**Lamptype**  
 <math>\angle</math> QR-CB 51 GU5,3/GX5,3 (1) 50W 12V

**Dimensions**  
 <math>\longleftrightarrow</math> L140xB60xH450

**Ref**  
 W1313.32  
 W1313.37

build-up  
60VA

W1314/.. - CUBA

~230V   IP54    2,0401  0,5 m  05.10.02 



bollard with spike - directional - with glass - with transformer  
Pollerleuchte mit Erdspieß - schwenkbar - mit Glas - mit Trafo

**Lamptype**  
 <math>\angle</math> QR-CB 51 GU5,3/GX5,3 (1) 50W 12V

**Dimensions**  
 <math>\longleftrightarrow</math> L140xB60xH650

**Ref**  
 W1314.32  
 W1314.37

build-up  
60VA

**W1315/.. - CUBA**

~230V   IP44    2,4351  0,5 m  05.10.02  



bollard with spike - directional - with glass - with transformer  
Pollerleuchte mit Erdspieß - schwenkbar - mit Glas - mit Trafo

**Ref**

W1315.32

W1315.37

**Lamptype**

◁ QR-CB 51 GU5,3/GX5,3 (1) 50W 12V

**Dimensions**

↔ L140xB60xH850

build-up  
60VA

**W1316/.. - CUBA**

~230V   IP54    2,7149  0,5 m  05.10.02  



bollard with spike - directional - with glass - with transformer  
Pollerleuchte mit Erdspieß - schwenkbar - mit Glas - mit Trafo

**Ref**

W1316.32

W1316.37

**Lamptype**

◁ QR-CB 51 GU5,3/GX5,3 (2) 50W 12V

**Dimensions**

↔ L340xB60xH650

build-up  
2x60VA

**W1324/.. - CUBA**

~230V   IP54    3,3110  0,5 m  05.10.02  



bollard with spike - directional - with glass - with transformer  
Pollerleuchte mit Erdspieß - schwenkbar - mit Glas - mit Trafo

**Ref**

W1324.32

W1324.37

**Lamptype**

◁ QR-CB 51 GU5,3/GX5,3 (2) 50W 12V

**Dimensions**

↔ L340xB60xH850

build-up  
2x60VA

**W1330/.. - CUBA**

~230V   IP44    1,3440  0,5 m  05.10.02  



bollard - directional - with glass - with transformer  
Pollerleuchte - schwenkbar - mit Glas - mit Trafo

**Ref**

W1330.32

W1330.37

**Lamptype**

◁ QR-CB 51 GU5,3/GX5,3 (1) 50W 12V

**Dimensions**

↔ Ø90xH520xD120

**Options**

T1021/.. - IRIS - CUBA SPIKE

build-up  
60VA

**W1331/.. - CUBA**

~230V



bollard - directional - with glass - with transformer  
Pollerleuchte - schwenkbar - mit Glas - mit Trafo

**Ref**

W1331.32

W1331.37

**Lamp type**

QR-CB 51 GU5,3/GX5,3 (2) 50W 12V

**Dimensions**

Ø90xH540xD230

**Options**

T1021/.. - IRIS - CUBA SPIKE

build-up  
2x60VA

**W1332/.. - CUBA**

~230V



bollard - directional - with glass - with transformer  
Pollerleuchte - schwenkbar - mit Glas - mit Trafo

**Ref**

W1332.32

W1332.37

**Lamp type**

QR-CB 51 GU5,3/GX5,3 (2) 50W 12V

**Dimensions**

Ø90xH640xD280

**Options**

T1021/.. - IRIS - CUBA SPIKE

build-up  
2x60VA

**T1332/.. - CUBA SPIKE**

IP20



spike  
Erdspeiß

**Ref**

T1332

**Dimensions**

Ø60xH400

build-in

**W1301.220/.. - CUBA**

~230V



build-up wall light - with glass  
Wandleuchte für Aufbau - mit Glas

**Ref**

W1301.220.20

W1301.220.30

W1301.220.31

W1301.220.32

W1301.220.37

W1301.220.50

**Lamp type**

QPAR 51 GU10 (1) 50W 230V

**Dimensions**

Ø60xH80xD105

Ø55xH30

**Options**

T1332/.. - CUBA SPIKE

build-up

**W1303.220/.. - CUBA**

~230V  IP44    0,8375  1 m  05.10.02 



build-up wall light - directional - with glass  
Wandleuchte für Aufbau - schwenkbar - mit Glas

**Ref**

- W1303.220.20
- W1303.220.30
- W1303.220.31
- W1303.220.32
- W1303.220.37
- W1303.220.50

**Lamptype**

 QPAR 51 GU10 (1) 50W 230V

**Dimensions**

 B200xH110xD160  
 H Ø55xH30

**Options**

T1332/.. - CUBA SPIKE

**W1317.220/.. - CUBA**

~230V  IP44    1,6060  1 m  05.10.02 



build-up wall light - with glass  
Wandleuchte für Aufbau - mit Glas

**Ref**

- W1317.220.20
- W1317.220.30
- W1317.220.31
- W1317.220.32
- W1317.220.37
- W1317.220.50

**Lamptype**

 QPAR 51 GU10 (2) 50W 230V

**Dimensions**

 B200xH80xD112  
 H L200xB40

build-up

**W1318.220/.. - CUBA**

~230V  IP44    1,7622  1 m  05.10.02 



build-up wall light - directional - with glass  
Wandleuchte für Aufbau - schwenkbar - mit Glas

**Ref**

- W1318.220.20
- W1318.220.30
- W1318.220.31
- W1318.220.32
- W1318.220.37
- W1318.220.50

**Lamptype**

 QPAR 51 GU10 (2) 50W 230V

**Dimensions**

 B200xH110xD150  
 H L200xB40

build-up

**W1319.220/.. - CUBA**

~230V  IP44    1,0389  1 m  05.10.02 



build-up wall light - with glass  
Wandleuchte für Aufbau - mit Glas

**Ref**

- W1319.220.20
- W1319.220.30
- W1319.220.31
- W1319.220.32
- W1319.220.37
- W1319.220.50

**Lamptype**

 QPAR64 GU10 (1) 75W 230V







**Dimensions**

 B74xH92xD122  
 H Ø55

build-up





W1320.220/.. - CUBA

~230V  IP44    1,2287  1 m  05.10.02 



build-up wall light - directional - with glass  
Wandleuchte für Aufbau - schwenkbar - mit Glas

**Lamptype**  
 QPAR64 GU10 (1) 75W 230V

**Dimensions**  
 B74xH110xD155  
 Ø55

**Ref**  
 W1320.220.20  
 W1320.220.30  
 W1320.220.31  
 W1320.220.32  
 W1320.220.37  
 W1320.220.50

build-up



W1321.220/.. - CUBA

~230V  IP44    2,3743  1 m  05.10.02 



build-up wall light - with glass  
Wandleuchte für Aufbau - mit Glas

**Lamptype**  
 QPAR64 GU10 (2) 75W 230V

**Dimensions**  
 B200xH92xD136  
 L200xB40

**Ref**  
 W1321.220.20  
 W1321.220.30  
 W1321.220.31  
 W1321.220.32  
 W1321.220.37  
 W1321.220.50

build-up



W1322.220/.. - CUBA

~230V  IP44    2,5136  1 m  05.10.02 



build-up wall light - directional - with glass  
Wandleuchte für Aufbau - schwenkbar - mit Glas

**Lamptype**  
 QPAR64 GU10 (2) 75W 230V

**Dimensions**  
 B200xH110xD155  
 L200xB40

**Ref**  
 W1322.220.20  
 W1322.220.30  
 W1322.220.31  
 W1322.220.32  
 W1322.220.37  
 W1322.220.50

build-up



W1080/.. - DROP

~12V   IP33    0,9000  0,5 m  05.10.02 



build-up wall light - without transformer  
Wandleuchte für Aufbau - ohne Trafo

**Lamptype**  
 QR-CB 51 coolfit GU5,3/GX5,3 (2) 35W 12V

**Dimensions**  
 B140xH80xD109  
 L73xB60

**Ref**  
 W1080.36

build-up  
use coolfit lamp  
Coolfit-Lampe verwenden

**W1081/.. - DROP**

~230V   IP33   1,2000  0,5 m  



build-up wall light - with transformer  
Wandleuchte für Aufbau - mit Trafo

Ref  
W1081.36

**Lamptype**  
QR-CB 51 coolfit GU5,3/GX5,3 (2) 35W 12V

**Dimensions**  
B140xH150xD109  
L150xB60

build-up  
105VA - use coolfit lamp  
Coolfit-Lampe verwenden

**T1082/.. - DROP**

~230V   IP33   0,5 m  0,5 m  



bollard - with transformer  
Pollerleuchte - mit Trafo

Ref  
T1082.36

**Lamptype**  
QR-CB 51 coolfit GU5,3/GX5,3 (2) 35W 12V

**Dimensions**  
L140xB109xH730  
L120xB120

2x60VA - use coolfit lamp  
Coolfit-Lampe verwenden

**W1207/./MT - EXTER**

~230V   IP44   0,0029  1 m  



build-up wall light - directional - with transformer  
Wandleuchte für Aufbau - schwenkbar - mit Trafo







Ref  
W1207.40.MT 481,46

**Lamptype**  
QR-LP111 G53 (1) 50W 12V

**Dimensions**  
B180xH140xD230  
Ø140

build-up  
60VA

**W1209.35W/.. - EXTER**

~230V   IP44   3,9200  1 m  



build-up wall light - directional - with electronic gear  
Wandleuchte für Aufbau - schwenkbar - mit elektronischem  
Vorschaltgerät

Ref  
W1209.35W.40 571,03

**Lamptype**  
HIR-CE111 GX8,5 (1) 35W 230V

**Dimensions**  
B180xH140xD360  
Ø140

build-up

**W1209.70W/.. - EXTER**

~230V

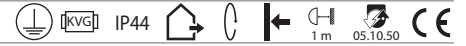

build-up wall light - directional - with magnetic gear  
Wandleuchte für Aufbau - schwenkbar - mit magnetischem Vorschaltgerät

**Ref**

W1209.70W.40

571,03

**Lamptype**

HIT-TC-CE G8,5 (1) 70W 230V

**Dimensions**

B180xH140xD360

Ø140

build-up

**W1070/.. - UFO**

~12V



build-up wall light - with glass - without transformer  
Wandleuchte für Aufbau - mit Glas - ohne Trafo

**Ref**

W1070.5

W1070.5B

W1070.5BB

W1070.32

W1070.36

W1070.37

**Lamptype**

QR-CB 51 coolfit GU5,3/GX5,3 (1) 35W 12V

**Dimensions**

Ø60xD167

Ø60

build-up  
use coolfit lamp  
Coolfit-Lampe verwenden

**W1071/.. - UFO**

~230V



build-up wall light - with glass - with transformer  
Wandleuchte für Aufbau - mit Glas - mit Trafo

**Ref**

W1071.5

W1071.5B

W1071.5BB

W1071.32

W1071.36

W1071.37

**Lamptype**

QR-CB 51 coolfit GU5,3/GX5,3 (1) 35W 12V

**Dimensions**

B70xH70xD207

L70xB70

build-up  
60VA - use coolfit lamp  
Coolfit-Lampe verwenden

**W1072/.. - UFO**

~230V



build-up wall light - with glass - with transformer  
Wandleuchte für Aufbau - mit Glas - mit Trafo

**Ref**

W1072.5

W1072.5B

W1072.5BB

W1072.32

W1072.36

W1072.37

**Lamptype**

QR-CB 51 coolfit GU5,3/GX5,3 (2) 35W 12V

**Dimensions**

B200xH55xD287

L200xB55

build-up  
105VA - use coolfit lamp  
Coolfit-Lampe verwenden

W1073/.. - UFO

~230V



build-up wall light - with glass - with transformer  
Wandleuchte für Aufbau - mit Glas - mit Trafo

Ref

- W1073.5
- W1073.5B
- W1073.5BB
- W1073.32
- W1073.36
- W1073.37

Lamp type

QR-CB 51 coolfit GU5,3/GX5,3 (1) 35W 12V

Dimensions

↔ B70xH70xD610

⬇ L70xB70

build-up  
60VA - use coolfit lamp  
Coolfit-Lampe verwenden

T1033/.. - UFO

~230V



bollard with spike - with glass - with transformer  
Pollerleuchte mit Erdspeiß - mit Glas - mit Trafo

Ref

- T1033.5
- T1033.5B
- T1033.5BB
- T1033.32
- T1033.36
- T1033.37

Lamp type

QR-CB 51 coolfit GU5,3/GX5,3 (1) 35W 12V

Dimensions

↔ Ø60xH450

60VA - use coolfit lamp  
Coolfit-Lampe verwenden

T1034/.. - UFO

~230V



bollard with spike - with glass - with transformer  
Pollerleuchte mit Erdspeiß - mit Glas - mit Trafo

Ref

- T1034.5
- T1034.5B
- T1034.5BB
- T1034.32
- T1034.36
- T1034.37

Lamp type

QR-CB 51 coolfit GU5,3/GX5,3 (1) 35W 12V

Dimensions

↔ Ø60xH650

60VA - use coolfit lamp  
Coolfit-Lampe verwenden

T1035/.. - UFO

~230V



bollard with spike - with glass - with transformer  
Pollerleuchte mit Erdspeiß - mit Glas - mit Trafo

Ref

- T1035.5
- T1035.5B
- T1035.5BB
- T1035.32
- T1035.36
- T1035.37

Lamp type

QR-CB 51 coolfit GU5,3/GX5,3 (1) 35W 12V

Dimensions

↔ Ø60xH850

60VA - use coolfit lamp  
Coolfit-Lampe verwenden

T1037/.. - UFO

~230V   IP44    5,7248  0,5 m  05.10.02  



bollard with spike - with glass - with transformer  
Pollerleuchte mit Erdspieß - mit Glas - mit Trafo

Ref

- T1037.5
- T1037.5B
- T1037.5BB
- T1037.32
- T1037.36
- T1037.37

Lamptype

 QR-CB 51 coolfit GU5,3/GX5,3 (2) 35W 12V

Dimensions

 Ø60xL310xH650

2x60VA - use coolfit lamp  
Coolfit-Lampe verwenden

T1038/.. - UFO

~230V   IP44    1,5552  0,5 m  05.10.02  



bollard with spike - with glass - with transformer  
Pollerleuchte mit Erdspieß - mit Glas - mit Trafo

Ref

- T1038.5
- T1038.5B
- T1038.5BB
- T1038.32
- T1038.36
- T1038.37

Lamptype

 QR-CB 51 coolfit GU5,3/GX5,3 (2) 35W 12V

Dimensions

 Ø60xL310xH850

2x60VA - use coolfit lamp  
Coolfit-Lampe verwenden

T1036.45/.. - UFO

~230V   IP44    6,6187  0,5 m  05.10.02  



bollard - with glass - with transformer  
Pollerleuchte - mit Glas - mit Trafo

Ref

- T1036.45.5
- T1036.45.5B
- T1036.45.5BB
- T1036.45.32
- T1036.45.36
- T1036.45.37

Lamptype

 QR-CB 51 coolfit GU5,3/GX5,3 (1) 35W 12V

Dimensions

 L100xB100xH450

 L100xB100

60VA - use coolfit lamp  
Coolfit-Lampe verwenden

T1036.65/.. - UFO

~230V   IP44    6,7928  0,5 m  05.10.02  



bollard - with glass - with transformer  
Pollerleuchte - mit Glas - mit Trafo

Ref

- T1036.65.5
- T1036.65.5B
- T1036.65.5BB
- T1036.65.32
- T1036.65.36
- T1036.65.37

Lamptype

 QR-CB 51 coolfit GU5,3/GX5,3 (1) 35W 12V

Dimensions

 L100xB100xH650

 L100xB100

60VA - use coolfit lamp  
Coolfit-Lampe verwenden

T1036.85/.. - UFO

~230V   IP44    9,1797  0,5 m   



bollard - with glass - with transformer  
Pollerleuchte - mit Glas - mit Trafo

Ref

T1036.85.5  
T1036.85.5B  
T1036.85.5BB  
T1036.85.32  
T1036.85.36  
T1036.85.37

Lamptype

 QR-CB 51 coolfit GU5,3/GX5,3 (1) 35W 12V

Dimensions

 L100xB100xH850

 L100xB100

60VA - use coolfit lamp  
Coolfit-Lampe verwenden

T1039.65/.. - UFO

~230V   IP44    0,8582  0,5 m   



bollard - with glass - with transformer  
Pollerleuchte - mit Glas - mit Trafo

Ref

T1039.65.5  
T1039.65.5B  
T1039.65.5BB  
T1039.65.32  
T1039.65.36  
T1039.65.37

Lamptype

 QR-CB 51 coolfit GU5,3/GX5,3 (2) 35W 12V

Dimensions

 L310xB100xH650

 L100xB100

2x60VA - use coolfit lamp  
Coolfit-Lampe verwenden

T1039.85/.. - UFO

~230V   IP44    5,5023  0,5 m   



bollard - with glass - with transformer  
Pollerleuchte - mit Glas - mit Trafo

Ref

T1039.85.5  
T1039.85.5B  
T1039.85.5BB  
T1039.85.32  
T1039.85.36  
T1039.85.37

Lamptype

 QR-CB 51 coolfit GU5,3/GX5,3 (2) 35W 12V

Dimensions

 L310xB100xH850

 L100xB100

2x60VA - use coolfit lamp  
Coolfit-Lampe verwenden

T1030/.. - UFO

~12V   IP44    0,5601  0,5 m   



bollard with spike - with 1,5m cable - with glass - without transformer  
Pollerleuchte mit Erdspieß - mit 1,5m Kabel - mit Glas - ohne Trafo

Ref

T1030.5  
T1030.5B  
T1030.5BB  
T1030.32  
T1030.36  
T1030.37

Lamptype

 QR-CB 51 coolfit GU5,3/GX5,3 (1) 35W 12V

Dimensions

 Ø60xH400

use coolfit lamp - alu spike  
Coolfit-Lampe verwenden - Erdspieß in Alu

T1030/..5M - UFO

~12V 0,1592 0,5 m 05.10.02



bollard with spike - with 5m cable - without transformer  
Pollerleuchte mit Erdspieß - mit 5m Kabel - ohne Trafo

Lamptype

QR-CB 51 coolfit GU5,3/GX5,3 (1) 35W 12V

Dimensions

Ø60xH400

Ref

- T1030.5.5M
- T1030.5B.5M
- T1030.5BB.5M
- T1030.32.5M
- T1030.36.5M
- T1030.37.5M

use coolfit lamp - alu spike  
Coolfit-Lampe verwenden - Erdspieß in Alu

T1031/.. - UFO

~230V IP44 2,8780 0,5 m 05.10.02



bollard with spike - with glass - with transformer  
Pollerleuchte mit Erdspieß - mit Glas - mit Trafo

Lamptype

QR-CB 51 coolfit GU5,3/GX5,3 (1) 35W 12V

Dimensions

L70xB70xH400

Ref

- T1031.5
- T1031.5B
- T1031.5BB
- T1031.32
- T1031.36
- T1031.37

60VA - use coolfit lamp  
Coolfit-Lampe verwenden

T1032/.. - UFO

~230V IP44 0,8668 0,5 m 05.10.02



bollard with spike - with glass - with transformer  
Pollerleuchte mit Erdspieß - mit Glas - mit Trafo

Lamptype

QR-CB 51 coolfit GU5,3/GX5,3 (2) 35W 12V

Dimensions

L200xB60xH400

Ref

- T1032.5
- T1032.5B
- T1032.5BB
- T1032.32
- T1032.36
- T1032.37

105VA - use coolfit lamp  
Coolfit-Lampe verwenden

00 UFOSEALINGRING/..12V - UFO

IP20 0,1890



supplement - sealing ring  
Supplement - Dichtungsring

Ref

00 UFOSEALINGRING.12V

## OUTDOOR | Aluminium | UFO GRANDE

UNIVERSAL UFO - Head IP65 (Ø64xH125) for several types of lamps and wattages. To be mentioned on the order: e.g. QPAR51 GU10 230V - 50W / 11W (energy saving) / 7W (LED) - 12V on request - UNIVERSELLER UFO - Kopf IP65 (Ø64xH125) für verschiedene Lamptypen und Wattleistungen. Auf der Bestellung erwähnen: z.B. QPAR51 GU10 230V - 50W / 11W (Sparlampe) / 7W (LED) - 12V auf Anfrage

### W7070/.. - UFO GRANDE

~230V



build-up wall light - with glass  
Wandleuchte für Aufbau - mit Glas

Ref

W7070.5

#### Lamptype

☞ QPAR 51 GU10 (1) 50W 230V

W7070.5B

or ☞ QPAR 51 LED GU10 (1) 7W 230V

W7070.5BB

#### Dimensions

↔ Ø60

W7070.32

W7070.36

W7070.37

build-up

### W7071/.. - UFO GRANDE

~230V



build-up wall light - with glass  
Wandleuchte für Aufbau - mit Glas

Ref

W7071.5

#### Lamptype

☞ QPAR 51 GU10 (1) 50W 230V

W7071.5B

or ☞ QPAR 51 LED GU10 (1) 7W 230V

W7071.5BB

#### Dimensions

↔ B70xH70

W7071.32

W7071.36

W7071.37

build-up

### W7072/.. - UFO GRANDE

~230V



build-up wall light - with glass  
Wandleuchte für Aufbau - mit Glas

Ref

W7072.5

#### Lamptype

☞ QPAR 51 GU10 (2) 50W 230V

W7072.5B

or ☞ QPAR 51 LED GU10 (2) 7W 230V

W7072.5BB

#### Dimensions

↔ B200xH55

W7072.32

W7072.36

W7072.37

build-up

### W7073/.. - UFO GRANDE

~230V



build-up wall light - with glass  
Wandleuchte für Aufbau - mit Glas

Ref

W7073.5

#### Lamptype

☞ QPAR 51 GU10 (1) 50W 230V

W7073.5B

or ☞ QPAR 51 LED GU10 (1) 7W 230V

W7073.5BB

#### Dimensions

↔ B70xH70xD610

W7073.32

W7073.36

☛ B70xH70

W7073.37

build-up



## OUTDOOR | Aluminium | UFO GRANDE

UNIVERSAL UFO - Head IP65 (Ø64xH125) for several types of lamps and wattages. To be mentioned on the order: e.g. QPAR51 GU10 230V - 50W / 11W (energy saving) / 7W (LED) - 12V on request - UNIVERSELLER UFO - Kopf IP65 (Ø64xH125) für verschiedene Lamptypen und Wattleistungen. Auf der Bestellung erwähnen: z.B. QPAR51 GU10 230V - 50W / 11W (Sparlampe) / 7W (LED) - 12V auf Anfrage

### T7033.45/.. - UFO GRANDE

~230V  IP54    1,6800  0.5 m  05.10.02 



bollard with spike - with glass  
Pollerleuchte mit Erdspieß - mit Glas

#### Ref

T7033.45.5  
T7033.45.5B  
T7033.45.5BB  
T7033.45.32  
T7033.45.36  
T7033.45.37

#### Lamptype

 QPAR 51 GU10 (1) 50W 230V  
or  QPAR 51 LED GU10 (1) 7W 230V

#### Dimensions

 H450

### T7033.65/.. - UFO GRANDE

~230V  IP54    2,0400  0.5 m  05.10.02 



bollard with spike - with glass  
Pollerleuchte mit Erdspieß - mit Glas

#### Ref

T7033.65.5  
T7033.65.5B  
T7033.65.5BB  
T7033.65.32  
T7033.65.36  
T7033.65.37

#### Lamptype

 QPAR 51 GU10 (1) 50W 230V  
or  QPAR 51 LED GU10 (1) 7W 230V

#### Dimensions

 H650

### T7033.85/.. - UFO GRANDE

~230V  IP54    2,0400  0.5 m  05.10.02 



bollard with spike - with glass  
Pollerleuchte mit Erdspieß - mit Glas

#### Ref

T7033.85.5  
T7033.85.5B  
T7033.85.5BB  
T7033.85.32  
T7033.85.36  
T7033.85.37

#### Lamptype

 QPAR 51 GU10 (1) 50W 230V  
or  QPAR 51 LED GU10 (1) 7W 230V

#### Dimensions

 H850

### T7037.65/.. - UFO GRANDE

~230V  IP54    2,0400  0.5 m  05.10.02 



bollard with spike - with glass  
Pollerleuchte mit Erdspieß - mit Glas

#### Ref

T7037.65.5  
T7037.65.5B  
T7037.65.5BB  
T7037.65.32  
T7037.65.36  
T7037.65.37

#### Lamptype

 QPAR 51 GU10 (2) 50W 230V  
or  QPAR 51 LED GU10 (2) 7W 230V

#### Dimensions

 H650

## OUTDOOR | Aluminium | UFO GRANDE

UNIVERSAL UFO - Head IP65 (Ø64xH125) for several types of lamps and wattages. To be mentioned on the order: e.g. QPAR51 GU10 230V - 50W / 11W (energy saving) / 7W (LED) - 12V on request - UNIVERSELLER UFO - Kopf IP65 (Ø64xH125) für verschiedene Lamptypen und Wattleistungen. Auf der Bestellung erwähnen: z.B. QPAR51 GU10 230V - 50W / 11W (Sparlampe) / 7W (LED) - 12V auf Anfrage

### T7037.85/.. - UFO GRANDE

~230V



bollard with spike - with glass  
Pollerleuchte mit Erdspiß - mit Glas

#### Ref

T7037.85.5

#### Lamptype

☞ QPAR 51 GU10 (2) 50W 230V

T7037.85.5B

or ☞ QPAR 51 LED GU10 (2) 7W 230V

T7037.85.5BB

T7037.85.32

#### Dimensions

T7037.85.36

↔ H850

T7037.85.37

### T7036.45/.. - UFO GRANDE

~230V



bollard - with glass  
Pollerleuchte - mit Glas

#### Ref

T7036.45.5

#### Lamptype

☞ QPAR 51 GU10 (1) 50W 230V

T7036.45.5B

or ☞ QPAR 51 LED GU10 (1) 7W 230V

T7036.45.5BB

T7036.45.32

#### Dimensions

T7036.45.36

↔ H450

T7036.45.37

### T7036.65/.. - UFO GRANDE

~230V



bollard - with glass  
Pollerleuchte - mit Glas

#### Ref

T7036.65.5

#### Lamptype

☞ QPAR 51 GU10 (1) 50W 230V

T7036.65.5B

or ☞ QPAR 51 LED GU10 (1) 7W 230V

T7036.65.5BB

T7036.65.32

#### Dimensions

T7036.65.36

↔ H650

T7036.65.37

### T7036.85/.. - UFO GRANDE

~230V



bollard - with glass  
Pollerleuchte - mit Glas

#### Ref

T7036.85.5

#### Lamptype

☞ QPAR 51 GU10 (1) 50W 230V

T7036.85.5B

or ☞ QPAR 51 LED GU10 (1) 7W 230V

T7036.85.5BB

T7036.85.32

#### Dimensions

T7036.85.36

↔ H850

T7036.85.37

## OUTDOOR | Aluminium | UFO GRANDE

UNIVERSAL UFO - Head IP65 (Ø64xH125) for several types of lamps and wattages. To be mentioned on the order: e.g. QPAR51 GU10 230V - 50W / 11W (energy saving) / 7W (LED) - 12V on request - UNIVERSELLER UFO - Kopf IP65 (Ø64xH125) für verschiedene Lamptypen und Wattleistungen. Auf der Bestellung erwähnen: z.B. QPAR51 GU10 230V - 50W / 11W (Sparlampe) / 7W (LED) - 12V auf Anfrage

### T7039.65/.. - UFO GRANDE

~230V



bollard - with glass  
Pollerleuchte - mit Glas

#### Ref

T7039.65.5

#### Lamptype

☞ QPAR 51 GU10 (2) 50W 230V

T7039.65.5B

or ☞ QPAR 51 LED GU10 (2) 7W 230V

T7039.65.5BB

#### Dimensions

↔ H650

T7039.65.32

T7039.65.36

T7039.65.37

### T7039.85/.. - UFO GRANDE

~230V



bollard - with glass  
Pollerleuchte - mit Glas

#### Ref

T7039.85.5

#### Lamptype

☞ QPAR 51 GU10 (2) 50W 230V

T7039.85.5B

or ☞ QPAR 51 LED GU10 (2) 7W 230V

T7039.85.5BB

#### Dimensions

↔ H850

T7039.85.32

T7039.85.36

T7039.85.37

### T7030/.. - UFO GRANDE

~230V



bollard with spike - with 1,5m cable - with glass  
Pollerleuchte mit Erdspieß - mit 1,5m Kabel - mit Glas

#### Ref

T7030.5

#### Lamptype

☞ QPAR 51 GU10 (1) 50W 230V

T7030.5B

or ☞ QPAR 51 LED GU10 (1) 7W 230V

T7030.5BB

#### Dimensions

↔ H400

T7030.32

T7030.36

T7030.37

### T7030/.. /5M - UFO GRANDE

~230V



bollard with spike - with 5m cable  
Pollerleuchte mit Erdspieß - mit 5m Kabel

#### Ref

T7030.5.5M

#### Lamptype

☞ QPAR 51 GU10 (1) 50W 230V

T7030.5B.5M

or ☞ QPAR 51 LED GU10 (1) 7W 230V

T7030.5BB.5M

#### Dimensions/Abmessungen

↔ H400

T7030.32.5M

T7030.36.5M

T7030.37.5M

## OUTDOOR | Aluminium | UFO GRANDE | UFO | VITO

UNIVERSAL UFO - Head IP65 (Ø64xH125) for several types of lamps and wattages. To be mentioned on the order: e.g. QPAR51 GU10 230V - 50W / 11W (energy saving) / 7W (LED) - 12V on request - UNIVERSELLER UFO - Kopf IP65 (Ø64xH125) für verschiedene Lamptypen und Wattleistungen. Auf der Bestellung erwähnen: z.B. QPAR51 GU10 230V - 50W / 11W (Sparlampe) / 7W (LED) - 12V auf Anfrage

### T7031/.. - UFO GRANDE

~230V  IP44    1,1150  0,5 m  05.10.02  





bollard with spike - with glass  
Pollerleuchte mit Erdspieß - mit Glas

#### Ref

T7031.5  
T7031.5B  
T7031.5BB  
T7031.32  
T7031.36  
T7031.37

#### Lamptype

 QPAR 51 GU10 (1) 50W 230V  
or  QPAR 51 LED GU10 (1) 7W 230V

#### Dimensions

 L70xB70xH400

### T7032/.. - UFO GRANDE

~230V  IP44    0,5 m  05.10.02  



bollard with spike - with glass  
Pollerleuchte mit Erdspieß - mit Glas

#### Ref

T7032.5  
T7032.5B  
T7032.5BB  
T7032.32  
T7032.36  
T7032.37

#### Lamptype

 QPAR 51 GU10 (2) 50W 230V  
or  QPAR 51 GU10 (2) 7W 230V

#### Dimensions

 L200xB60xH400

### 00 UFOSEALINGRING/.. /230V - UFO

IP20   0,1890  

supplement - sealing ring  
Supplement - Dichtungsring

#### Ref

00 UFOSEALINGRING.230V

### W1060/.. - VITO

~12V   IP44    0,3300  0,5 m  05.10.02  



build-up wall light - down - without transformer  
Wandleuchte für Aufbau - down - ohne Trafo

#### Ref

W1060.31  
W1060.32  
W1060.34  
W1060.35  
W1060.36

#### Lamptype

 QR-CB 51 coolfit GU5,3/GX5,3 (1) 50W 12V

#### Dimensions

 Ø55xH125xD100

 L45xB50

build-up  
use coolfit lamp  
Coolfit-Lampe verwenden

**W1061/.. - VITO**

~230V   IP44    0,5100  0,5 m  05.10.02 



build-up wall light - down - with transformer  
Wandleuchte für Aufbau - down - mit Trafo



**Ref**

- W1061.31
- W1061.32
- W1061.34
- W1061.35
- W1061.36

**Lamptype**

 QR-CB 51 coolfit GU5,3/GX5,3 (1) 35W 12V

**Dimensions**

 Ø55xH125xD100  
 L117xB40

*build-up  
use coolfit lamp - 60VA  
Coolfit-Lampe verwenden - 60VA*

**T100.A/.. - IRIS**

~230V   IP66    1,2300  0,5 m  05.10.02 



bollard - with transformer  
Pollerleuchte - mit Trafo

**Lamptype**

 QT12 GY6,35 (1) 50W 12V

**Dimensions**

 Ø90

**Options**

- T1021/.. - IRIS - CUBA SPIKE
- T1023/.. - IRIS Type A

Colour	T1001A/..	T1002A/..	T1003A/..	T1004A/..	T1005A/..
	H 200	H 400	H 600	H 800	H 1000
	32				
	34				
	35				
	36				



Aluminium outdoor

**T100.B/.. - IRIS**

~230V   IP66    1,200  0,5 m  05.10.02 



bollard - with transformer  
Pollerleuchte - mit Trafo

**Lamptype**

 QT12 GY6,35 (1) 50W 12V

**Dimensions**

 Ø90

**Options**

T1021/.. - IRIS - CUBA SPIKE

T1024/.. - IRIS Type B

Colour	T1001B/.. H 200	T1002B/.. H 400	T1003B/.. H 600	T1004B/.. H 800	T1005B/.. H 1000
32					
34					
35					
36					

**T100.E/.. - IRIS**

~230V   IP66    1,1200  0,5 m  05.10.02 



bollard - with transformer  
Pollerleuchte - mit Trafo

**Lamptype**

 QT12 GY6,35 (1) 50W 12V

**Dimensions**

 Ø90

**Options**

T1021/.. - IRIS - CUBA SPIKE

T1026/.. - IRIS Type E

Colour	T1001E/.. H 200	T1002E/.. H 400	T1003E/.. H 600	T1004E/.. H 800	T1005E/.. H 1000
32					
34					
35					
36					

**T100.F/.. - IRIS**

~230V   IP66    1,100  0,5 m  05.10.02 



bollard - with transformer  
Pollerleuchte - mit Trafo

**Lamptype**

 QT12 GY6,35 (1) 50W 12V

**Dimensions**

 Ø90

**Options**

T1021/.. - IRIS - CUBA SPIKE

T1029/.. - IRIS Type F

Colour	T1001F/..	T1002F/..	T1003F/..	T1004F/..	T1005F/..
	H 200	H 400	H 600	H 800	H 1000
32					
34					
35					
36					

**T100.D/.. - IRIS**

~230V   IP66    1,160  0,5 m  05.10.02 



bollard - with transformer  
Pollerleuchte - mit Trafo

**Lamptype**

 QT12 GY6,35 (1) 50W 12V

**Dimensions**

 Ø90

**Options**

T1021/.. - IRIS - CUBA SPIKE

T1025/.. - IRIS Type D

Colour	T1001D/..	T1002D/..	T1003D/..	T1004D/..	T1005D/..
	H 200	H 400	H 600	H 800	H 1000
32					
34					
35					
36					

T100..A/.. - IRIS

~230V



IP66



1,1300



0.5 m



05.10.02



bollard  
Pollerleuchte

**Lamptype**

☑ CFL G9 (1) 7W 230V

**Dimensions**

↔ Ø90

**Options**

T1021/.. - IRIS - CUBA SPIKE

T1023/.. - IRIS Type A

Colour	T1006A/.. H 160	T1007A/.. H 360	T1008A/.. H 560	T1009A/.. H 760	T1010A/.. H 960
32					
34					
35					
36					

T100..B/.. - IRIS

~230V



IP66



1,0900



0.5 m



05.10.02



bollard  
Pollerleuchte

**Lamptype**

☑ CFL G9 (1) 7W 230V

**Dimensions**

↔ Ø90

**Options**

T1021/.. - IRIS - CUBA SPIKE

T1024/.. - IRIS Type B

Colour	T1006B/.. H 160	T1007B/.. H 360	T1008B/.. H 560	T1009B/.. H 760	T1010B/.. H 960
32					
34					
35					
36					



T100..D/.. - IRIS

~230V



IP66



1,0500

0,5 m



05.10.02



bollard  
Pollerleuchte

**Lamptype**

☑ CFL G9 (1) 7W 230V

**Dimensions**

↔ Ø90

**Options**

T1021/.. - IRIS - CUBA SPIKE

T1025/.. - IRIS Type D

Colour	T1006D/..	T1007D/..	T1008D/..	T1009D/..	T1010D/..
	H 160	H 360	H 560	H 760	H 960
32					
34					
35					
36					

T100..E/.. - IRIS

~230V



IP66



1,0100

0,5 m



05.10.02



bollard  
Pollerleuchte

**Lamptype**

☑ CFL G9 (1) 7W 230V

**Dimensions**

↔ Ø90

**Options**

T1021/.. - IRIS - CUBA SPIKE

T1026/.. - IRIS Type E

Colour	T1006E/..	T1007E/..	T1008E/..	T1009E/..	T1010E/..
	H 160	H 360	H 560	H 760	H 960
32					
34					
35					
36					

T100..F/.. - IRIS

~230V



IP66



0,9600



0,5 m



05.10.02



bollard  
Pollerleuchte

**Lamptype**

CFL G9 (1) 7W 230V

**Dimensions**

Ø90

**Options**

T1021/.. - IRIS - CUBA SPIKE

T1029/.. - IRIS Type F

Colour	T1006F/..	T1007F/..	T1008F/..	T1009F/..	T1010F/..
	H 160	H 360	H 560	H 760	H 960
32					
34					
35					
36					

T101.C/./.. - IRIS

~230V



IP54



0,8500



0,5 m



05.10.02



bollard  
Pollerleuchte

**Lamptype**

mini lynx longlife E27 (1) 11W 230V

**Dimensions**

Ø90

**Options**

T1021.T30/.. - IRIS

T1021.T5/.. - IRIS

T1021/.. - IRIS - CUBA SPIKE

T1027/.. - IRIS Type C

Colour	T1011C/..	T1012C/..	T1013C/..	T1014C/..	T1015C/..
	H 260	H 460	H 660	H 860	H 1060
5					
5B					
30					
32					
34					
35					
36					

T101..CR/.. - IRIS

~230V



bollard  
Pollerleuchte

Lamptype

mini lynx longlife E27 (1) 11W 230V

Dimensions

Ø90

Options

T1021/.. - IRIS - CUBA SPIKE

T1028/.. - IRIS Type CR

Colour	T1016CR/..	T1017CR/..	T1018CR/..	T1019CR/..	T1020CR/..
	H 260	H 460	H 660	H 860	H 1060
32					
34					
35					
36					

T1021/.. - IRIS - CUBA SPIKE

IP20



spike  
Erdspieß

Ref

T1021

Dimensions

Ø90xH400

T1022/.. - IRIS

IP20



accessories for garden lighting  
Zubehör für Gartenleuchten

Ref

T1022

Dimensions

L150xB150

T1/.. - IRIS

IP20   0,6600 



accessories for garden lighting - base  
Zubehör für Gartenleuchten - Fuß

**Dimensions**

↔ Ø90xH30

Ref

T1

T1MT/.. - IRIS

IP20   0,6600 



accessories for garden lighting - base  
Zubehör für Gartenleuchten - Fuß

**Dimensions**

↔ Ø90xH60

Ref

T1MT

T2/.. - IRIS

IP20   1,6190 



accessories for garden lighting - flat base - alu  
Zubehör für Gartenleuchten - platter Fuß - Alu

Ref

T2

T3/.. - IRIS

IP20   0,3090 



accessories for garden lighting - base connector  
Zubehör für Gartenleuchten - Basisverbinder

Ref

T3

T4/.. - IRIS

IP20   1,7160 

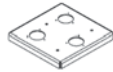

accessories for garden lighting - base plate  
Zubehör für Gartenleuchten - Fußplatte

Ref  
T4

T5/.. - IRIS

IP20  



accessories for garden lighting - flat base - stainless steel  
Zubehör für Gartenleuchten - platter Fuß - Edelstahl

Ref  
T5

T../.. - IRIS

IP20  



accessories for garden lighting - extension tube  
Zubehör für Gartenleuchten - Verlängerungsstück

Colour	T100/..	T20/..	T40/..	T60/..	T80/..
	H 1000	H 200	H 400	H 600	H 800

T1023/.. - IRIS Type A

IP20  



accessories for garden lighting - type A  
Zubehör für Gartenleuchten - Typ A

Dimensions

↔ Ø53xH120

Ref  
T1023.31  
T1023.32  
T1023.34  
T1023.35  
T1023.36

T1024/.. - IRIS Type B

IP20   0,0560 



accessories for garden lighting - type B  
Zubehör für Gartenleuchten - Typ B

**Dimensions**

↔ Ø53xH120

**Ref**

T1024.31  
T1024.32  
T1024.34  
T1024.35  
T1024.36

T1025/.. - IRIS Type D

IP20  



accessories for garden lighting - type D  
Zubehör für Gartenleuchten - Typ D

**Dimensions**

↔ Ø53xH120

**Ref**

T1025.31  
T1025.32  
T1025.34  
T1025.35  
T1025.36

T1026/.. - IRIS Type E

IP20   0,0532 



accessories for garden lighting - type E  
Zubehör für Gartenleuchten - Typ E

**Dimensions**

↔ Ø53xH120

**Ref**

T1026.31  
T1026.32  
T1026.34  
T1026.35  
T1026.36

T1027/.. - IRIS Type C

IP20   0,3249 



accessories for garden lighting - type C  
Zubehör für Gartenleuchten - Typ C

**Dimensions**

↔ Ø53xH250

**Ref**

T1027.5  
T1027.5B  
T1027.31  
T1027.32  
T1027.34  
T1027.35  
T1027.36

T1028/.. - IRIS Type CR

IP20   0.0622 



accessories for garden lighting - type CR  
Zubehör für Gartenleuchten - Typ CR

**Dimensions**

↔ Ø53xH210

**Ref**

T1028.31  
T1028.32  
T1028.34  
T1028.35  
T1028.36

T1029/.. - IRIS Type F

IP20  



accessories for garden lighting - type F  
Zubehör für Gartenleuchten - Typ F

**Dimensions**

↔ Ø53xH120

**Ref**

T1029.31  
T1029.32  
T1029.34  
T1029.35  
T1029.36

W1050A/.. - IRIS

~230V   IP44   0.9930  0.5 m  05.10.02 



build-up wall light - with transformer  
Wandleuchte für Aufbau - mit Trafo

**Lamptype**

☞ QT12 GY6,35 (1) 50W 12V

**Dimensions**

↔ Ø53xH420xD210

**Options**

T1023/.. - IRIS Type A

**Ref**

W1050A.31  
W1050A.32  
W1050A.34  
W1050A.35  
W1050A.36

build-up  
60VA

W1051A/.. - IRIS

~230V  IP44   0.8900  0.5 m  05.10.02 



build-up wall light  
Wandleuchte für Aufbau

**Lamptype**

☞ CFL G9 (1) 7W 230V

**Dimensions**

↔ Ø53xH320xD175

**Options**

T1023/.. - IRIS Type A

**Ref**

W1051A.31  
W1051A.32  
W1051A.34  
W1051A.35  
W1051A.36

12V - 50W on request  
auf Anfrage

**W1052B/.. - IRIS**

~230V   IP44    0,8860  0,5 m  05.10.02 



build-up wall light - with transformer  
Wandleuchte für Aufbau - mit Trafo

**Lamptype**

 QT12 GY6,35 (1) 50W 12V

**Dimensions**

 Ø53xH420xD210

**Options**

T1024/.. - IRIS Type B

**Ref**

- W1052B.31
- W1052B.32
- W1052B.34
- W1052B.35
- W1052B.36

build-up  
60VA

**W1052D/.. - IRIS**

~230V   IP44    0,8812  0,5 m  05.10.02 



build-up wall light - with transformer  
Wandleuchte für Aufbau - mit Trafo

**Lamptype**

 QT12 GY6,35 (1) 50W 12V

**Dimensions**

 Ø53xH420xD210

**Options**

T1025/.. - IRIS Type D

**Ref**

- W1052D.31
- W1052D.32
- W1052D.34
- W1052D.35
- W1052D.36

build-up  
60VA

**W1052E/.. - IRIS**

~230V   IP44    0,8650  0,5 m  05.10.02 



build-up wall light - with transformer  
Wandleuchte für Aufbau - mit Trafo

**Lamptype**

 QT12 GY6,35 (1) 50W 12V

**Dimensions**

 Ø53xH420xD210

**Options**

T1026/.. - IRIS Type E

**Ref**

- W1052E.31
- W1052E.32
- W1052E.34
- W1052E.35
- W1052E.36

build-up  
60VA

**W1052F/.. - IRIS**

~230V   IP44    0,8500  0,5 m  05.10.02 



build-up wall light - with transformer  
Wandleuchte für Aufbau - mit Trafo

**Lamptype**

 QT12 GY6,35 (1) 50W 12V

**Dimensions**

 Ø53xH420xD210

**Options**

T1029/.. - IRIS Type F

**Ref**

- W1052F.31
- W1052F.32
- W1052F.34
- W1052F.35
- W1052F.36

build-up  
60VA



**W1053B/.. - IRIS**

~230V



build-up wall light  
Wandleuchte für Aufbau

**Lamptype**

☑ CFL G9 (1) 7W

230V

**Dimensions**

↔ Ø53xH320xD175

**Options**

T1024/.. - IRIS Type B

**Ref**

- W1053B.31
- W1053B.32
- W1053B.34
- W1053B.35
- W1053B.36

*build-up*  
12V - 50W on request  
auf Anfrage

**W1053D/.. - IRIS**

~230V



build-up wall light  
Wandleuchte für Aufbau

**Lamptype**

☑ CFL G9 (1) 7W

230V

**Dimensions**

↔ Ø53xH320xD175

**Options**

T1025/.. - IRIS Type D

**Ref**

- W1053D.31
- W1053D.32
- W1053D.34
- W1053D.35
- W1053D.36

*build-up*  
12V - 50W on request  
auf Anfrage

**W1053E/.. - IRIS**

~230V



build-up wall light  
Wandleuchte für Aufbau

**Lamptype**

☑ CFL G9 (1) 7W

230V

**Dimensions**

↔ Ø53xH320xD175

**Options**

T1026/.. - IRIS Type E

**Ref**

- W1053E.31
- W1053E.32
- W1053E.34
- W1053E.35
- W1053E.36

*build-up*  
12V - 50W on request  
auf Anfrage

**W1053F/.. - IRIS**

~230V

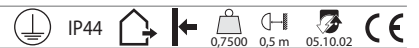

build-up wall light  
Wandleuchte für Aufbau

**Lamptype**

☑ CFL G9 (1) 7W

230V

**Dimensions**

↔ Ø53xH320xD175

**Options**

T1029/.. - IRIS Type F

**Ref**

- W1053F.31
- W1053F.32
- W1053F.34
- W1053F.35
- W1053F.36

*build-up*  
12V - 50W on request  
auf Anfrage

W1054C/.. - IRIS

~230V

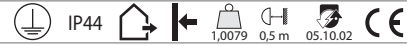

build-up wall light  
Wandleuchte für Aufbau

Ref

Lamptype

☞ mini lynx longlife E27 (1) 11W

230V

W1054C.5  
W1054C.5B  
W1054C.31

Dimensions

↔ Ø53xH420xD230

W1054C.32  
W1054C.34

Options

T1027/.. - IRIS Type C

W1054C.35  
W1054C.36

build-up

W1055CR/.. - IRIS

~230V

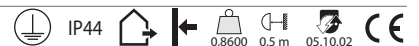

build-up wall light  
Wandleuchte für Aufbau

Ref

Lamptype

☞ mini lynx longlife E27 (1) 11W

230V

W1055CR.31  
W1055CR.32  
W1055CR.34  
W1055CR.35  
W1055CR.36

Dimensions

↔ Ø53xH420xD230

Options

T1028/.. - IRIS Type CR

build-up

W1056A/.. - IRIS

~230V



build-up wall light - with transformer  
Wandleuchte für Aufbau - mit Trafo

Ref

Lamptype

☞ QT12 GY6,35 (1) 50W

12V

W1056A.31  
W1056A.32  
W1056A.34  
W1056A.35  
W1056A.36

Dimensions

↔ Ø53xH245xD100

Options

T1023/.. - IRIS Type A

build-up  
60VA

W1057B/.. - IRIS

~230V



build-up wall light - with transformer  
Wandleuchte für Aufbau - mit Trafo

Ref

Lamptype

☞ QT12 GY6,35 (1) 50W

12V

W1057B.31  
W1057B.32  
W1057B.34  
W1057B.35  
W1057B.36

Dimensions

↔ Ø53xH245xD100

Options

T1024/.. - IRIS Type B

build-up  
60VA

**W1057D/.. - IRIS**

~230V   IP44    0,8000  0,5 m  05.10.02 



build-up wall light - with transformer  
Wandleuchte für Aufbau - mit Trafo

**Lamptype**

 QT12 GY6,35 (1) 50W 12V

**Dimensions**

 Ø53xH245xD100

**Options**

T1025/.. - IRIS Type D

**Ref**

- W1057D.31
- W1057D.32
- W1057D.34
- W1057D.35
- W1057D.36

build-up  
60VA

**W1057E/.. - IRIS**

~230V   IP44    0,7500  0,5 m  05.10.02 



build-up wall light - with transformer  
Wandleuchte für Aufbau - mit Trafo

**Lamptype**

 QT12 GY6,35 (1) 50W 12V

**Dimensions**

 Ø53xH245xD100

**Options**

T1026/.. - IRIS Type E

**Ref**

- W1057E.31
- W1057E.32
- W1057E.34
- W1057E.35
- W1057E.36

build-up  
60VA

**W1057F/.. - IRIS**

~230V   IP44    0,6990  0,5 m  05.10.02 



build-up wall light - with transformer  
Wandleuchte für Aufbau - mit Trafo

**Lamptype**

 QT12 GY6,35 (1) 50W 12V

**Dimensions**

 Ø53xH245xD100

**Options**

T1029/.. - IRIS Type F

**Ref**

- W1057F.31
- W1057F.32
- W1057F.34
- W1057F.35
- W1057F.36

build-up  
60VA

**W1058C/.. - IRIS**

~230V  IP44    0,7400  0,5 m  05.10.02 



build-up wall light  
Wandleuchte für Aufbau

**Lamptype**

 mini lynx longlife E27 (1) 11W 230V

**Dimensions**

 Ø53xH337xD100

**Options**

T1027/.. - IRIS Type C

**Ref**

- W1058C.31
- W1058C.32
- W1058C.34
- W1058C.35
- W1058C.36

build-up

**W1059CR/.. - IRIS**

~230V



build-up wall light  
Wandleuchte für Aufbau

**Ref**

W1059CR.31

**Lamptype**

W1059CR.32

mini lynx longlife E27 (1) 11W

230V

W1059CR.34

**Dimensions**

W1059CR.35

Ø53xH337xD100

W1059CR.36

**Options**

T1028/.. - IRIS Type CR

build-up

**W1085/.. - NEMO**

~230V



build-up wall light - with glass - with transformer  
Wandleuchte für Aufbau - mit Glas - mit Trafo

**Ref**

W1085.36

**Lamptype**

QT12 GY6,35 (1) 50W

12V

**Dimensions**

Ø60xH150xD75

Ø60

build-up  
60VA

**W1086/.. - NEMO**

~12V



build-up wall light - with glass - without transformer  
Wandleuchte für Aufbau - mit Glas - ohne Trafo

**Ref**

W1086.36

**Lamptype**

QT12 GY6,35 (1) 50W

12V

**Dimensions**

Ø60xH150xD75

Ø60

build-up

**W1087/.. - NEMO**

~230V



build-up wall light - with transformer  
Wandleuchte für Aufbau - mit Trafo

**Ref**

W1087.36

**Lamptype**

QT12 GY6,35 (1) 50W

12V

**Dimensions**

Ø60xH150xD75

Ø60

build-up  
60VA

**W1088/.. - NEMO**

~12V IP44 0,5 m



build-up wall light - without transformer  
Wandleuchte für Aufbau - ohne Trafo

**Ref**  
W1088.36

**Lamptype**  
 QT12 GY6,35 (1) 50W 12V

**Dimensions**  
 Ø60xH150xD75  
 Ø60

build-up

**T301.75/.. - OLYMPIA**

~230V IP44 1,500 1 m



bollard - with glass  
Pollerleuchte - mit Glas

**Ref**  
T301.75.36

**Lamptype**  
 QT14 G9 (1) 40W 230V

**Dimensions**  
 L65xB80xH750  
 L120xB120

**W301/.. - OLYMPIA**

~230V IP44 1 m



build-up wall light - with glass  
Wandleuchte für Aufbau - mit Glas

**Ref**  
W301.36

**Lamptype**  
 QT14 G9 (1) 40W 230V

**Dimensions**  
 B60xH140xD100  
 L60xB140

build-up

**T302.700/.. - PIEDRO**

~230V IP44 0,1725 1 m



bollard with spike  
Pollerleuchte mit Erdspeiß

**Ref**  
T302.700.32  
T302.700.34  
T302.700.35  
T302.700.36

**Lamptype**  
 QT14 G9 (1) 40W 230V

**Dimensions**  
 L230xB40xH700

**Options**  
S302/.. - PIEDRO

T302.1000/.. - PIEDRO

~230V



bollard with spike  
Pollerleuchte mit Erdspeiß

Ref

T302.1000.32  
T302.1000.34  
T302.1000.35  
T302.1000.36

Lamptype

QT14 G9 (1) 40W 230V

Dimensions

L230xB40xH1000

Options

S302/.. - PIEDRO

S302/.. - PIEDRO

IP20

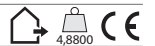

accessories for garden lighting - base  
Zubehör für Gartenleuchten - Fuß

Ref

S302

Dimensions

H700

T1040.100/.. - RYTA

=700mA



bollard - without LED driver  
Pollerleuchte - ohne Driver LED

Ref

T1040.100.36.CW  
T1040.100.36.B

Lamptype

powered 700mA . (1) 3W 700mA

Dimensions

Ø54xH224 40° reflector

Ø54

other °angle reflector on demand  
andere °Winkel Reflektor auf Anfrage

T1040.400/.. - RYTA

=700mA



bollard - without LED driver  
Pollerleuchte - ohne Driver LED

Ref

T1040.400.36.CW  
T1040.400.36.B

Lamptype

powered 700mA . (1) 3W 700mA

Dimensions

Ø54xH524 40° reflector

Ø54

other °angle reflector on demand  
andere °Winkel Reflektor auf Anfrage

T1041.100/.. - RYTA

~230V   IP44    0,5 m  



bollard - with LED driver  
Pollerleuchte - mit Driver LED

Ref  
T1041.100.36.CW  
T1041.100.36.B

**Lamptype**  
 powered 700mA . (1) 3W 700mA

**Dimensions**  
↔ Ø54xH264  40° reflector  
⊥ Ø54

other °angle reflector on demand  
andere °Winkel Reflektor auf Anfrage

T1041.400/.. - RYTA

~230V   IP44    0,8300  0,5 m  



bollard - with LED driver  
Pollerleuchte - mit Driver LED

Ref  
T1041.400.36.CW  
T1041.400.36.B

**Lamptype**  
 powered 700mA . (1) 3W 700mA

**Dimensions**  
↔ Ø54xH564  40° reflector  
⊥ Ø54

other °angle reflector on demand  
andere °Winkel Reflektor auf Anfrage

T1042.100/.. - RYTA

=700mA   IP44    0,5 m  



bollard - without LED driver  
Pollerleuchte - ohne Driver LED

Ref  
T1042.100.36.CW  
T1042.100.36.B

**Lamptype**  
 powered 700mA . (2) 3W 700mA

**Dimensions**  
↔ Ø54xH224  40° reflector  
⊥ Ø54

other °angle reflector on demand  
andere °Winkel Reflektor auf Anfrage

T1042.400/.. - RYTA

=700mA   IP44    0,5 m  



bollard - without LED driver  
Pollerleuchte - ohne Driver LED

Ref  
T1042.400.36.CW  
T1042.400.36.B

**Lamptype**  
 powered 700mA . (2) 3W 700mA

**Dimensions**  
↔ Ø54xH524  40° reflector  
⊥ Ø54

other °angle reflector on demand  
andere °Winkel Reflektor auf Anfrage

**T1043.100/.. - RYTA**

~230V   IP44    1,0150  0,5 m  05.10.02  





bollard - with LED driver  
Pollerleuchte - mit Driver LED

Ref  
T1043.100.36.CW  
T1043.100.36.B

**Lamptype**

 powered 700mA . (2) 3W 700mA

**Dimensions**

 Ø54xH264  40° reflector

 Ø54

other °angle reflector on demand  
andere °Winkel Reflektor auf Anfrage

**T1043.400/.. - RYTA**

~230V   IP44    0,6100  0,5 m  05.10.02  



bollard - with LED driver  
Pollerleuchte - mit Driver LED

Ref  
T1043.400.36.CW  
T1043.400.36.B

**Lamptype**

 powered 700mA . (2) 3W 700mA

**Dimensions**

 Ø54xH564  40° reflector

 Ø54

other °angle reflector on demand  
andere °Winkel Reflektor auf Anfrage

**CLEANING - ONDERHOUD - NETTOYAGE - REINIGUNG**

Do not spray any pesticides on to the devices, nor clean with solvent based cleaning products.

Niet besproeien met pesticiden noch andere tuinsproeistoffen. Niet reinigen met producten op basis van solventen of detergents.

Ne pas arroser l'appareil avec des produits chimiques tels que pesticides, herbicides, etc. Ne pas nettoyer avec solvants ou détergents.

Die Leuchten nicht bespritzen mit Pestiziden. Nicht sauber machen mit Solvente oder Detergente.





000A/..	74	032/..	121	160.80/..	70
000B3/..	167	33/..	16	160.160.80/..	72
00GLAS5MM/..	552	40.10/..	113	161.10/..	110
00GLAS5MMSQ/..	553	43/..	16	162.10/..	113
00GLAS9MM/..	552	50./..	127	170/..	73
00GLAS9MMSQ/..	553	50.10/..	114	180.80/..	70
00GLASLAVAD140.9M/..	567	60./..	131	180.180.80/..	72
00HERSTGLAS5MM/..	553	60.10/..	114	181.10/..	110
00HERSTGLAS5MMSQ/..	554	61./..	129	182.10/..	113
00HERSTGLAS9MM/..	553	61.10/..	109	190/..	74
00HERSTGLAS9MMSQ/..	554	62./..	133	200.80/..	70
00HERSTGLASD140.9MM/..	567	63./..	129	201/..	95, 513
00 UFOSEALINGRING/./12V	605, 651	64./..	132	202./..	470
00 UFOSEALINGRING/./230V	610, 656	065/./..	111	202/..	40, 512
001/..	116	065.65/./..	115	202.B/..	40, 512
002/..	109	66./..	134	210/..	74
2xø65	22, 26	67./..	134	220.80/..	71
2xø70	30	68./..	131	240.80/..	71
2xø80 CONVERTIBLE SYSTEM	57	69./..	128	280./..	444
2xø80 SYSTEM	47	70./..	126	300V/./12V	20, 508
2xø85-87 SCS SYSTEM	78	70x70	45, 46	300V/./230V	21, 509
2xø90 SCS SYSTEM	78	71./..	130	301V/..	20, 508
003/..	116	72./..	130	301V.230V/..	21, 509
003.RAL/..	4	73x73	41	302V/..	20, 508
3xø80 CONVERTIBLE SYSTEM	58	74.65/..	134	302V.230V/..	21, 509
3xø85-87 SCS SYSTEM	79	74.100/..	134	303V/..	20, 508
3xø90 SCS SYSTEM	79	74LED.65/..	140	303V.230V/..	21, 509
004/..	117	74LED.100/..	140	350PU004/..	412
005/..	117	75x75 BETA SYSTEM	218	350PU008/..	413
006/..	122	75x147 BETA SYSTEM	220	599.45/..	183
006/./T	122	75x218 BETA SYSTEM	221	599.230V.80/..	183
007/..	122	80./..	127	599.ZT.80/..	183
008/..	123	080/./..	111	600.80/..	183
010/..	107	80.10/..	114	600.ES63.45/..	184
011/..	107	080.80/./..	115	601.230V.45/..	184
012/..	123	81.10/..	109	601.230V.75/..	184
013/..	108	90./..	126	602.230V.45/..	184
014/..	108	90/..	72	602.230V.75/..	185
015/./..	107	92x92 INOX 316	95, 513	603.230V.45/..	185
016/..	123	95x95	94	603.230V.75/..	185
017/..	119	100/./..	112	604.230V.45/..	185
018/..	107	100.10/..	114	604.230V.75/..	186
019/..	108	100.80/..	69	605.230V.45/..	186
020/..	118	100.100/./..	116	605.230V.75/..	186
020.B3/./..	118	100.100.80/..	71	611.75/..	186
021/..	118	101.10/..	109	612.75/..	187
021.B3/./..	119	101H/..	95, 513	613.75/..	187
022/..	108	102.10/..	112	614.75/..	187
023.M6/..	106	102H/..	40, 513	615.75/..	187
023.M10/..	106	110/..	73	616.AR70.45/..	188
024/..	106	120.80/..	69	616.DICRO.45/..	188
024CV350/..	412	120.120.80/..	71	616.ES50.45/..	188
024CV700/..	412	121.10/..	110	616.ES63.45/..	188
025/..	119	122.10/..	112	617.AR70.45/..	189
025.B3/./..	120	130/..	73	617.DICRO.45/..	189
026/..	120	140.80/..	70	617.ES50.45/..	189
026.B3/./..	121	140.140.80/..	72	617.ES63.45/..	189
027/..	120	141.10/..	110	618.AR70.45/..	190
28./..	444	142.10/..	113	618.DICRO.45/..	190
028/..	122	150/..	73	618.ES50.45/..	190

618.ES63.45/..	190	752.220/..	176	943/..	174
619.AR70.45/..	191	753.220/..	176	944.220/..	176
619.DICRO.45/..	191	807/..	167	945A/..	255
619.E550.45/..	191	808/..	168	945B/..	255, 256
619.ES63.45/..	191	809/..	168	945.MT/..	255
620.AR70.45/..	192	810/..	166	945/..S1	255
620.DICRO.45/..	192	814/..	170	945/..S2	255
620.E550.45/..	192	815/..	166	946/..	256
620.ES63.45/..	192	816/..	166	946.MT/..	256
621.AR70/..	207	817/..	168	947/..	257
621.DICRO/..	207	821/..	202	947/..B	257
621.E550/..	207	822/..	202	948/..	256
621.ES63/..	207	823/..	204	949/..	257
622.AR70/..	208	824/..	204	950/..	248
622.DICRO/..	208	856/..	180	952/..	248
622.E550/..	209	857/..	180	953/..	268
622.ES63/..	209	858/..	180	954/..	268
623.AR70/..	209	859/..	45, 180	955/..	269
623.DICRO/..	209	860/..	181	956/..	269
623.E550/..	210	861A/..	178	958/..	249
623.ES63/..	210	862A/..	178	959/..	249
624.AR70/..	210	863A/..	178	960/..	250
624.DICRO/..	210	864A/..	178	960A/..	250
624.E550/..	211	896.A/..	181	961/..	251
624.ES63/..	211	897.A/..	181	961A/..	251
625.AR70/..	208	898.A/..	181	970/..	251
625.DICRO/..	208	899.A/..	182	972/..	198
627.75/..	205	900.A/..	182	973/..	198
628.75/..	205	901.A/..	182	978/..	193
629.35/..	205	905/..	301	978/..T	300
630.47/..	205	905/..PAR30	301	979/..	193
631.35/..	206	911/..	195	979LED/..	193
632.47/..	206	912/..	196	979LED/..T	300
633.35/..	206	913/..	196	981/..	193
634.47/..	206	914/..	196	981LED/..	194
640.100/..	198	919/..	197	982/..	194
640.200/..	198	920.A/..	182	982LED/..	194
640.300/..	199	923/..	202	983/..	194
640.400/..	199	924A/..	203	983LED/..	195
641.HL105/..	354	924B/..	203	984/..	195
641.HL335/..	354	925C/..	203	984LED/..	195
641.HL600/..	355	925D/..	203	985.A.12V/..	213
641.SL335/..	199, 355	926C/..	204	985.A.230V/..	214
641.SL600/..	199, 355	926D/..	204	985.B.12V/..	214
641.VL105/..	355	927/..	201	985.B.230V/..	214
641.VL335/..	356	928/..	201	985.C.12V/..	214
641.VL600/..	356	929/..	201	985.C.230V/..	215
642.250/..	212	930/..	202	986/..	213
642.350/..	212	931/..	172	987/..	213
646.600/..	200, 356	932.220/..	174	988/..	302
646.900/..	201, 357	933/..	172	989/..	302
646.1200/..	200, 356	934.220/..	175	990/../..	304
651/..	121, 171	935/..	173	990A/../..	304
652/..	171	936.220/..	175	990B/../..	304
653/..	172	937/..	173	991/..	177
654/..	172	938.220/..	175	992/..	177
700PU004/..	412	939/..	173	993/..	177
700PU008/..	413	940.220/..	175	994/..	177
750/..	174	941/..	173	995/..	211
751/..	174	942.220/..	176	996/..	211

997/..	212	1163.A/..	498	1244/..	327
998/..	212	1163.B/..	499	1244/./GLASS	327
999/./..	305	1163.D/..	499	1244.LED/..	397
999A/./..	305	1164.A/..	500	1244.LED/./GL	397
999B/./..	306	1164.B/..	501	1245A/..	328, 397
999C/./..	306	1164.D/..	501	1245B/..	328, 397
1100/..	489	1165.130.A/..	502	1246/..	328
1102/..	489	1165.130.B/..	503	1246/./GLASS	328
1103/..	498	1165.130.D/..	503	1246.LED/..	398
1105/..	498	1165.150.A/..	503	1246.LED/./GL	398
1109/..	496	1165.150.B/..	503	1247A/..	329, 398
1112/..	505	1165.150.D/..	504	1247B/..	329, 398
1114/..	558	1180.9/..	566	1248/..	329
1114GL/..	558	1181.9/..	566	1248/./GLASS	329
1115.100.5/..	552	1182/..	567	1248.LED/..	399
1115.100.9/..	552	1202/..	334	1248.LED/./GL	399
1115.135.5/..	555	1230A/..	324	1249A/..	330, 399
1115.135.9/..	555	1230B/..	325	1249B/..	330, 399
1117/..	500	1230C/..	325	1250/..	359
1119/..	500	1230D/..	325	1250/./C	359
1120/..	493	1230E/..	325	1253/..	252
1122.130/..	493	1230F/..	326	1254/..	251
1122.160/..	494	1230G/..	326	1255/..	252
1123/..	502	1230H/..	326	1256/..	252
1125.130/..	502	1230.LED/..	401	1257/..	252
1125.150/..	502	1230.LED.GYP/..	401	1258/..	253
1129.180/..	560	1231/..	326, 401	1259/..	346
1130.150/..	560	1232A/..	313	1260/..	346
1134/..	555	1232B/..	314	1261/..	346
1135.5/..	549	1232C/..	314	1262/..	347
1135.9/..	549	1232D/..	314	1263/..	347
1136.5/..	550	1232E/..	314	1266/..	347
1136.5.135/..	555	1232F/..	315	1267/..	347
1136.9/..	550	1232G/..	315	1269/..	360
1136.9.135/..	556	1232H/..	315	1270/..	360
1137.5/..	559	1234/..	315	1271/..	360
1137.9/..	559	1234B/..	316	1271.ES63/..	360
1138.5/..	551	1235A/..	316	1272/..	358
1138.5.135/..	555, 556	1235B/..	316	1273/..	358
1138.9/..	551	1235C/..	316	1280/..	362
1138.9.135/..	557	1236/..	317	1281/..	362
1141.160/..	560	1236PL18/..	317	1282/..	363
1142.130/..	561	1237/..	317	1285/..	339
1143/..	549	1237B/..	317	1286/..	275
1145/..	550	1238A/..	318	1287/..	213
1147/..	505	1238B/..	318	1288/..	135
1149.130/..	560	1238C/..	319	1289/..	343
1150/..	554	1239/..	318	1290/..	344
1150MICROLYNX/..	554	1239B/..	318	1291/..	344
1155/..	497	1239C/..	319	1293/..	215
1157/./..	506	1239D/..	319	1294/./B	363
1160.A/..	490	1240/..	330	1294/./W	363
1160.B/..	490	1240/./GLASS	330	1295A/..	312
1160.D/..	490	1240.LED/..	400	1295B/..	312
1161.130.A/..	494	1240.LED/./GL	400	1295C/..	312
1161.130.B/..	494	1241A/..	331, 400	1295D/..	312
1161.130.D/..	494	1241B/..	331, 400	1295E/..	313
1161.160.A/..	495	1242/..	331	1295F/..	313
1161.160.B/..	495	1243A/..	331	1295G/..	313, 638
1161.160.D/..	495	1243B/..	331, 332	1296B/..	322

1296C/..	322	1404/..	321	1479.MEGA/./S2	52
1296W/..	322	1404B/..	321	1480/..	260
1297B/..	323	1405/..	321	1481/..	260
1297C/..	323	1405B/..	322	1483/..	261
1297W/..	323	1412/..	275	1484/..	261
1298A/..	319	1413/..	275	1490/..	263
1298B/..	320	1414/..	276	1490LED/..	263
1298C/..	320	1415/..	276	1491/..	264
1298D/..	320	1416/..	276	1491LED/..	264
1299/..	323	1420B/..	338	1492/..	264
1299A/..	324	1420W/..	338	1492LED/..	264
1299X/..	324	1421B/..	338	1493/..	265
1299XA/..	324	1421W/..	338	1493LED/..	265
1344/./S1	393	1430/..	339	1494/..	265
1344/./S2	393	1431/..	339	1494LED/..	265
1345/./S1	395	1432/..	339	1495/..	266
1345/./S2	395	1435/..	273	1495LED/..	266
1346/./S1	394	1436/..	273	1496/..	266
1346/./S2	394	1437/..	273	1496LED/..	266
1347/./A	393	1438/..	273	1497/..	267
1347/./B	393	1439/..	274	1497LED/..	267
1347/./C	394	1440/..	274	1498/..	267
1348/./B	394	1441/..	269	1498LED/..	267
1348/./C	395	1442/..	270	1499/..	268
1351/./S1	395	1443/..	270	1499LED/..	268
1351/./S2	396	1444/..	271	1500/..	363
1352/./S1	396	1445/..	249	1520.7W/..	253
1352/./S2	396	1446/..	249	1520.13W/..	253
1354/./S1	380	1447/..	250	1520.26W/..	253
1354/./S2	381	1448/..	250	1520.42W/..	254
1355/./S1	379	1450/..	257	1522.13W/..	254
1355/./S2	380	1451/..	258	1522.26W/..	254
1356/./S1	382	1454/..	293	1522.42W/..	254
1356/./S2	383	1455.M10/..	296	1530/..	482
1357/./S1	384	1456.M10/..	257, 297	1531/..	482
1357/./S2	385	1457.M13/..	297	1532/..	483
1358/./S1	381	1458.M13/..	297	1533/..	483
1358/./S2	382	1459.M13/..	297	1540/..	308
1359/./S1	385	1461/..	269	1541/..	308
1359/./S2	386	1462/..	270	1542/..	306
1360/./S1	383	1463/..	270	1542.A/..	307
1360/./S2	384	1464/..	271	1542.B/..	307
1361/./S1	386	1470/..	292	1543/./..	307
1361/./S2	387	1473/..	293	1544/..	484
1362/./S1	387	1474.DICRO/./S1	50	1545/..	484
1362/./S2	388	1474.DICRO/./S2	50	1546/..	484
1365/..	391	1474.ES50/./S1	50	1547/..	484
1366/..	391	1474.ES50/./S2	50	1548/..	485
1367/..	392	1474.MEGA/./S1	51	1549/..	486
1370/..	368	1474.MEGA/./S2	51	1550/..	485
1371/..	368	1475/..	258	1551/..	485
1372/..	368	1476/..	259	1552/..	485
1374/..	368	1477/..	259	1553/..	486
1375/..	369	1478/..	259	1554/..	486
1376/..	369	1478B/..	258, 259	1560/..	483
1400/..	349	1479.DICRO/./S1	51	1561/..	483
1401/..	349	1479.DICRO/./S2	51	1600/..	348
1402/..	349	1479.ES50/./S1	52	1602/..	348
1403/..	320	1479.ES50/./S2	52	1605/..	344
1403B/..	321	1479.MEGA/./S1	52	1606/..	343

1630/..	404	1750.MEGA/..	335	1864/..	247
1630B/..	403	1751.ES50/..	336	1865/..	247
1631/..	405	1752.ES50/..	336	1866/..	248
1631B/..	404	1753.ES50/..	336	1867/..	248
1634.12V-AC/..	406	1754.ES50/..	336	1868/..	247
1634.12V-DC/..	406	1754.MEGA/..	337	1871/..	239
1634.24V-AC/..	407	1755.ES50/..	337	1871../A	239
1634.24V-DC/..	407	1756.ES50/..	337	1872/..	240
1634.230V/..	406	1760/..	58	1872../A	240
1634B.230V/..	406	1799/..	258	1873/..	240
1635.12V-AC/..	408	1800/..	258	1873../A	240
1635.12V-DC/..	408	1801/..	276	1874/..	241
1635.24V-AC/..	409	1802/..	277	1874../A	241
1635.24V-DC/..	409	1803/..	277	1875/..	242
1635.230V/..	408	1807.B2../E27	285	1876/..	242
1635B.230V/..	408	1807.B3../E27	285	1877/..	242
1636.12V-AC/..	410	1808/..	279	1878/..	242
1636.12V-DC/..	410	1808../B	279	1879/..	241
1636.24V-AC/..	411	1809../..	133	1879../A	241
1636.24V-DC/..	411	1810/..	280	1880/..	243
1636.230V/..	410	1811/..	282	1881../A	233
1636B.230V/..	410	1812/..	282	1881../DICRO	233
1660/..	427	1813/..	283	1881../ES50	233
1661/..	427	1814/..	283	1882../A	234
1662/..	427	1815/..	284	1882../DICRO	234
1663/..	427	1816/..	284	1882../ES50	234
1664A/..	428	1817.B1/..	285	1883../A	234, 235
1664B/..	428	1817.B3/..	286	1883../DICRO	234
1701.DICRO/..	226	1818.B2/..	286	1883../ES50	235
1701.ES50/..	226	1819../DOWN	287	1884../A	235, 236
1701.ES63/..	227	1819../UP	287	1884../DICRO	235
1701.MEGA/..	227	1820/..	278	1884../ES50	235
1702.DICRO/..	227	1825/..	278	1885../DICRO	237
1702.ES50/..	227	1830/..	308	1885../ES50	237
1702.MEGA/..	228	1831/..	308	1886../DICRO	237
1703.DICRO/..	228	1832/..	309	1886../ES50	237
1703.ES50/..	228	1840../DISCO	280	1887../DICRO	238
1703.MEGA/..	228	1840../YOKO	280	1887../ES50	238
1705.DICRO/..	229	1840../ZUMBA	281	1888../DICRO	238
1705.ES50/..	229	1841/..	295	1888../ES50	238
1706.DICRO/..	229	1845/..	280, 281	1889../A	236
1706.ES50/..	229	1845../A	281	1889../DICRO	236
1707.DICRO/..	230	1845../B	281	1889../ES50	236
1707.ES50/..	230	1850/..	233	1890../DICRO	239
1711.DICRO/..	230	1851/..	243	1890../ES50	239
1711.ES50/..	230	1851../A	243	1901/..	196
1711.MEGA/..	231	1852/..	243	1902/..	197
1712.DICRO/..	231	1852../A	243, 244	1903/..	197
1712.ES50/..	231	1853/..	244	1904/..	197
1712.MEGA/..	231	1853../A	244	1911../E27	287
1713.DICRO/..	232	1854/..	245	1911../ES50	288
1713.ES50/..	232	1855/..	245	1912../E27	288
1713.MEGA/..	232	1856/..	245	1912../ES50	288
1713.TCDE/..	232	1857/..	246	1913../E27	288
1717.TCDE/..	337	1858/..	246	1913../ES50	289
1741/..	300	1859/..	244	1914../E27	289
1742/..	301	1859../A	244, 245	1914../ES50	289
1743/..	301	1861/..	246	1915../E27	289
1750.ES50/..	335	1862/..	246	1915../ES50	290
1750.ES63/..	335	1863/..	247	1918.B2../E27	290

1918.B2../ES50	290	2101A/..	478	2305.24V.5/..	519
1918.B3../E27	290	2102A/..	478	2305.24V.9/..	519
1918.B3../ES50	291	2103A/..	479	2305.230V.5/..	518
1919../E27	291	2104A/..	479	2305.230V.9/..	519
1919../ES50	291	2105A/..	479	2306.5/..	489, 518
1920../E27	291	2106A/..	479	2306.9/..	489, 518
1920../ES50	292	2107A/..	480	2307.5/..	499, 533
1921../E27	292	2108A/..	480	2307.9/..	499, 533
1921../ES50	292	2125/..	480	2308.5/..	550
1950/..	293	2126/..	480	2309.5/..	491, 520
1951/..	293	2200.5/..	517	2309.9/..	492, 521
1952.M10/..	294	2200.9/..	517	2310.24V.5/..	492, 521
1952.M13/..	294	2202.5/..	517	2310.24V.9/..	493, 522
1953.A/..	295	2202.9/..	518	2310.230V.5/..	492, 521
1953.B/..	296	2203.5x/..	532	2310.230V.9/..	492, 521
1954.A/..	296	2203.9x/..	532	2311.5.130/..	495, 524
1954.B/..	296	2205.5/..	533	2311.5.160/..	496, 524
1955A.M13/..	295	2205.9/..	533	2311.9.130/..	524
1955B.M13/..	295	2206/..	527	2311.9.160/..	524
1956/..	132, 294	2207/..	527	2312.24V.5/..	526
1956.10/..	132	2208/..	527	2312.24V.9/..	526
1957/..	166	2209.5/..	528	2312.230V.5/..	525
1958/..	299	2209.9/..	528	2312.230V.9/..	525
1959A/..	167	2211.5/..	543	2313.5.130/..	504, 539
1959B/..	167	2211.9/..	543	2313.5.150/..	504, 540
1960../..	128	2213/..	527	2313.9.130/..	540
2001/..	466	2214.5/..	530	2313.9.150/..	540
2005/..	466	2214.9/..	531	2314.5/..	531
2006/..	466	2217.5/..	535	2314.9/..	531
2007/..	467	2217.9/..	535	2317.5/..	501, 536
2008/..	467	2219.5/..	536	2317.9/..	501, 536
2009/..	467	2219.9/..	536	2318.24V.5/..	537
2010/..	466	2220.5/..	522	2318.24V.9/..	537
2011/..	477	2220.9/..	522	2318.230V.5/..	537
2012/..	477	2222.5.130/..	523	2318.230V.9/..	537
2013/..	477	2222.5.160/..	523	2320.24V/..	103, 516, 581
2014/..	477	2222.9.130/..	523	2320.230V/..	103, 516, 581
2015/..	478	2222.9.160/..	523	2321.24V/..	488, 516
2016/..	476	2223.5/..	538	2321.230V/..	488, 516
2017/..	476	2223.9/..	538	2324.24V.5/..	542
2018/..	476	2225.5.130/..	538	2324.24V.9/..	542
2019/..	476	2225.5.150/..	539	2324.230V.5/..	541
2020/..	467	2225.9.130/..	539	2324.230V.9/..	541
2021/..	468	2225.9.150/..	539	2325.24V.5/..	534
2022/..	468	2227.5/..	490, 519	2325.24V.9/..	534
2023/..	468	2227.9/..	491, 520	2325.230V.5/..	534
2024/..	117, 468	2229.5/..	491, 520	2325.230V.9/..	534
2025/..	117, 469	2229.9/..	491, 520	2327.5/..	530
2026/..	469	2245.5/..	496, 529	2327.9/..	530
2027/..	469	2245.9/..	497, 529	2347.5/..	546
2029/..	469	2247.5/..	544	2347.9/..	546
2031/..	470	2247.9/..	544	2357.5/..	547
2033/..	471	2257.5/..	547	2357.9/..	548
2070/..	471	2257.9/..	547	2360.9/..	561
2075/..	472	2300.5/..	528	2361.9/..	561
2077/..	472	2300.9/..	529	2363.9/..	561
2078/..	472	2302.5/..	545	2364.9/..	562
2079/..	473	2302.9/..	545	2365.9/..	562
2080/..	472	2304.12V/..	557	2367.9/..	562
2100A/..	478	2304.230V/..	558	2368.9/..	562

2369.9/..	563	2554.B/..	460	3001/..	357
2370.9/..	563	2556.A/..	460	3002A/..	350
2371.9/..	563	2558.C/..	450	3002B/..	350
2374.9/..	563	2558.D/..	450	3004.DISCUS/..	135, 340
2375.9/..	564	2560.C/..	461	3004.JUPITER/..	135, 340
2376.9/..	564	2560.D/..	461	3004.STEP/..	136, 340
2377.9/..	564	2562.C/..	461	3005.DISCUS/..	136, 340
2380.9/..	564	2562.D/..	461	3005.JUPITER/..	136, 341
2381.9/..	565	2564.C/..	462	3005.STEP/..	136, 341
2383.9/..	565	2564.D/..	462	3006/..	341
2384.9/..	565	2566.C/..	462	3006/..T	341
2385.9/..	565	2567.SET/..	462	3007.DISCUS/..25	342
2386.9/..	566	2595/..	463	3007.JUPITER/..25	342
2387.9/..	566	2596/..	463	3007.STEP/..25	342
2501/..	447	2597/..	463	3008.DISCUS/..45	342
2502/..	448	2598/..	463	3008.JUPITER/..45	343
2503/..	448	2601/..	465	3008.STEP/..45	343
2504.C/..	449	2602/..	465	3010/..	361
2504.D/..	449	2603/..	465	3011/..	361
2511/..	447	2604/..	465	3012/..	361
2512/..	448	2620/..	436	3013/..	361
2513/..	448	2621/..	436	3015/..	334
2514.A/..	449	2622/..	436	3017/..	349
2514.B/..	449	2623/..	436	3020/..	300, 432
2516.A/..	451	2624/..	437	3021A/..	431
2516.B/..	451	2625/..	437	3021B/..	432
2518.A/..	451	2626/..	437	3022A/..	430
2518.B/..	451	2627/..	437	3022B/..	430
2520.C/..	452	2628/..	438	3022C/..	431
2520.D/..	452	2629/..	438	3023/..	141, 432
2522.C/..	452	2630/..	438	3028/..	353, 426
2522.D/..	452	2631/..	438	3029/..	353, 426
2524.A/..	453	2632/..	439	3030/..	350
2524.B/..	453	2633/..	439	3031/..	350
2526.A/..	453	2634/..	439	3032/..	351
2526.B/..	453	2635/..	439	3033/..	351
2528.C/..	454	2689/..	441	3034/..	351
2528.D/..	454	2690/..	441	3035/..	351
2530.C/..	454	2693/..	442	3036/..	348
2530.D/..	454	2694/..	443	3037/..	299
2532.A/..	456	2695/..	442	3038/..	299
2532.B/..	456	2696/..	442	3040/..	359
2534.A/..	456	2697/..	442	3041/..	359
2534.B/..	456	2698/..	443	3042/..T1	353
2536.A/..	457	2705/..	443	3042/..T2	354
2536.B/..	457	2706/..	443	3042/..T3	354
2538.A/..	457	2707/..	444	3043/..	353
2540.C/..	457	2708/..	444	3044/..	335
2540.D/..	458	2720/..	481	3050/..	352
2542.C/..	458	2721/..	481	3051/..	352
2542.D/..	458	2724/..	481	3052/..	200, 352
2544.C/..	458	2725/..	481	3053/..	200, 352
2546.C/..	459	2727/..	482	3054/..	378
2548.A/..	450	2728/..	482	3054A/..	378
2548.B/..	450	2809/..	445	3055/..	378
2550.A/..	459	2810/..	445	3056/..	377
2550.B/..	459	2811/..	445	3057/..	377
2552.A/..	459	2812/..	446	3058/..	401
2552.B/..	460	2813/..	445	3058B/..	402
2554.A/..	460	2814/..	446	3059/..	402

3059B/..	402	4006/..	272	464907/..	144
3060/..	101	4007/..	272	521406/..	145
3061/..B	97	4008/..	272	<b>A</b>	
3061/..W	97	4009/..	272	ADAPTION RING	69, 70, 71, 72, 73, 74
3062/..B	99	4010/..	274	ADAPTOR	106
3062/..W	99	4011/..	274, 303	ADAPTOR - M10	296, 297
3063/..	96	4012/..	275, 303	ADAPTOR - M13	297
3063/..ZA	96	4013/..	158	AMBON	293
3064/..	96	4013.B1/..	157	APOLLO 12V - M10	134
3065A/..	98	4013.B2/..	157	APOLLO 230V	138
3065B/..	98	4013.B3/..	157	AQUAGR/..	6, 41
3066/..	101	4014/..	159	AQUANODOTIP44/..	34
3067/..	101	4014.B1/..	158	ARC	335
3068/..	102	4014.B2/..	158	ARCA35/..	5, 19
3069/..	100	4014.B3/..	158	ARCA50/..	6, 19
3070/..	302	4015/..	160	ARCADE	334, 616
3071.G9/..	163	4015.B1/..	159	ARCADE NUMBER	616
3072/..	302	4015.B2/..	159	ARGOS	575
3074/..	101	4015.B3/..	159	ARIA/..	38, 510
3075/..	102	4016/..	161	ARIMA	577
3076/..	362	4016.B1/..	160	ATOMIS	299
3076B/..	362	4016.B2/..	160	AURA	334
3077/..40	423	4016.B3/..	160	AURORA IP44	619
3078/..40	423	4017/..	161	AVENUE	593
3079/..	100	4017.B2/..	161	AZUR	334
3080/..	334	4017.B3/..	161	<b>B</b>	
3081.10/..	421	4018/..	357	BAMBU	292, 293
3081.40/..	421	4019/..	162	BASE 4	197
3082.10/..	421	4019.B2/..	162	BETAPLUS	226 - 337
3082.40/..	421	4019.B3/..	162	BETA SYSTEM	218 - 226
3085/..	418	4020/..	358	BETA SYSTEM - M10	224
3086/..	418	4021.B1/..	162	BIBLOS	589
3087/..B1	433	4022/..	358	BISTRO	621, 622
3087/..B3	433	4023/..	357	BOB	622, 623
3088/..1W	431	4024/..	348	BOB GRANDE	623, 624
3088/..3W	431	4025/..	154	BOLERO	633, 634, 635, 636, 638
3089/..	433	4025.B3/..	154	BOLERO LED	424, 637
3095.MT/..	420	4025.W1/..	345	BOOSTER	301
3095.ZT/..	420	4025.W2/..	346	BORA50/..	44
3096.MT/..	420	4026/..	155	BOX	7, 8
3096.ZT/..	420	4026.B3/..	155	BOX1F/..	218, 219
3101/..	371	4026.W1/..	344	BOX2F/..	220
3102/..	371	4026.W2/..	345	BOX3F/..	221, 222
3103/..	371	4027/..	156	BRIDGE PLAFOND	258
3104/..	371	4027.B3/..	155	BRIDGE WALL	258
3999.G9/..	141	4027.W1/..	345	BRUNA voor frame bticino	408, 409, 410, 411
3999.G9.B3/..	141	4027.W2/..	345	BUTTERFLY	436 - 446
4000/..	106	4028/..	156	<b>C</b>	
4000.00/..	153	4028.B3/..	156	C000PUNCHED/..	616
4000.01/..	153	4030/..	303	C50/..	616, 617, 618, 619, 620
4000.02/..	154	4031/..	303	C90/..	616, 618, 619, 621, 622
4001.G4/..	142	4040/..	271	C96/..	616, 618, 619, 621, 622
4001.G4.B3/..	143	4041/..	271	CALIX	312
4001.G9/..	143	6500/..	135	CALIX box	313, 638
4001.G9.B3/..	143	121607/..	145	CALIX GRANDE	313, 638
4002/../..	152	174320/..	144	CALYPSO	198
4003/..	152	175820/..	144	CAMBIO/..	38, 511
4003.B3/..	152	184307/..	145	CAMERA IN	255, 256
4004/..	153	185807/..	144	CAMERA IN BOX VT	255, 256
4004.B3/..	153	461507/..	154		



CAMERA IN BOX ZT	255	CASPICOC/..	59	COCTAIL 12V - M10	126
CAMERA TWIN	257	CASPICODWN35/..	27	COLIBRI 12V -M10	127
CAMERA UP	255, 256, 257	CASPOLKA.AR70/..	66	COMMA 12V - M10	135, 136, 340
CANARIA	339	CASPOLKA.DICRO/..	66	COMMA MT	136, 340, 341
CANO35/..	25	CASPOLKA.ES50/..	66	COMPACT	313, 314, 315
CANO50/..	34	CASPOLKA.ES63/..	66	COMPACT box	314
CANVAS A	338	CASRIGAGLDICRO/..	88	COMPACT plasterkit	315
CANVAS B	338	CASRIGAGLE550/..	88	CONDOR 12V -M10	130
CAPRI 12V -M10	130	CASRIGAMICRO/..	89	CONNECTOR FOR TRACKS	106
CAPRI 230V - M10	138	CASROMA.DICRO/..	86	CONNECTOR FOR TRACKS - M6	106
CASALFA.DICRO/..	223	CASROMA.ES50/..	86	CONNECTOR FOR TRACKS - M10	106
CASALFA.ES50/..	223	CASSAMBA.DICRO/..	84	CONSUL	594
CASALFA.MEGA/..	223	CASSAMBA.ES50/..	84	CONVERTIBLE SYSTEM	34, 59, 60, 61, 63, 64, 65, 66, 67, 68
CASALTOAR70/..	91	CASSAXOC/..	63	68	
CASALTOES63/..	92	CASSIRA35/..	28	CONVERTIBLE SYSTEM - B3	62
CASANKA.DICRO/..	84	CASSIRAC/..	61	CONVERTIBLE SYSTEM - M10	62, 63
CASANKA.ES50/..	84	CASSULA.CDMTM/..	85	COSMOS	183
CASAQUANODOTC/..	65	CASSULA.HCITF/..	85	COSMOS cas Vera	183
CASARIAC/..	67	CASTARGA/..	65	COSMOS cas Volta	184
CASBETA.DICRO/..	223	CASTINTO.ES50/..	93	CRICKET 12V	135
CASBETA.ES50/..	224	CASTINTO.ES63/..	94	CROSS50/..	95, 513
CASCAMBIOC/..	67	CASTINTO.G9/..	94	CUBA	639, 640, 641, 642, 643, 644, 645
CASCAMBIODOWNC/..	68	CASTITUSC/..	65	CUBA SPIKE	639, 643
CASCANO35/..	27	CASTOMBA.DICRO/..	87	CUBIC	193, 194, 195, 300
CASCANOC/..	61	CASTOMBA.ES50/..	87	CUBIC 12V - M10	134
CASCINTO.DICRO/..	93	CASTURNERC/..	64	CUBIC + LED - M10	140
CASCINTO.ES50/..	93	CASVARIO50/..	47	CUPIDO I	207, 208
CASCOMO.DICRO/..	90	CASVARIO.ES50/..	47	CUPIDO II	208, 209
CASCOMO.ES50/..	91	CASVERA.E14/..	89	CUPIDO III	209, 210
CASCONGA.DICRO/..	86	CASVERA.E27/..	90	CUPIDO IV	210, 211
CASCONGA.ES50/..	86	CASVERSOC/..	63	CUSCO/..	41
CASDANA.E14/..	89	CASVIDRIOCI/..	64	CYCLOPE	594, 595
CASDANA.E27/..	89	CASVOLTA.AR70/..	93	<b>D</b>	
CASDECO50/..	48	CASVOLTA.DICRO/..	92	D33/..	5, 10
CASDISCO/..	31	CASVOLTA.ES50/..	92	D43/..	5, 11
CASDISCO.ES50/..	31	CASVOLTA.ES63/..	92	DAKAR	590
CASDIVA35/..	27	CASWALLC/..	61	DECO50/..	49
CASDIVAC/..	60	CASYOKO/..	31	DELFI	575
CASDIVADOWNC/..	60	CASYOKO.ES50/..	32	DELIA	573
CASECHO.2.DICRO/..	225	CASZENO35/..	28	DIONE	600
CASECHO.2.ES50/..	225	CASZENO35.B3/..	28	DISCO/..	28
CASECHO.2.MEGA/..	226	CASZENO.B3.C/..	62	DISCO.ES50/..	29
CASECHO.3.TCDE/..	226	CASZENOC/..	62	DISCOVERY 12V - M10	128
CASECHO.DICRO/..	224	CASZERO/..	85	DISCUS 12V - M10	131
CASECHO.ES50/..	225	CASZEROB3/..	85	DISCUS 230V - M10	137
CASECHO.MEGA/..	225	CASZORBA.DICRO/..	87	DISCUS + LED - M10	139
CASFINO.12V/..	224	CASZORBA.ES50/..	87	DISPLAY	341, 342, 343
CASFINO.230V/..	224	CESAR	379 - 382, 388, 389, 391, 392	DIVA35/..	24, 510
CASFORUMC/..	64	CESAR X	382 - 388, 390, 391	DIVA50/..	33, 511
CASHERO50/..	47	CIRCUIT	439, 440, 469, 470	DIVA50.ES50/..LN	37, 512
CASHERO.ES50/..	48	CLEAN	612	DIVA50/..LN	36, 512
CASLIMBO.DICRO/..	90	CLEAN.200/..	612	DIVA AR70/..	41
CASLIMBO.ES50/..	90	CLEAN.500/..	612	DOMINO 12V- M10	129
CASMIMBA.DICRO/..	88	CLIP	449 - 454	DOTS	378
CASMIMBA.ES50/..	88	CLIP DOUBLE	456 - 462	DOWNLIGHT D33	10
CASONO/..	31	CLIP SMALL	447, 448	DOWNLIGHT ø39-40	11
CASOUZO.DICRO/..	91	CLIP WALL	462	DRIVER constant current	412 - 417
CASOUZO.ES50/..	91	CLUB	339	DRIVER OT9/200-240/350	414
CASPDOWNC/..	59	COCO50/..	43	DRIVER OT18/200-240/700	414
CASPICO35/..	27	COCO.ES50/..	44		

DRIVER OT35/200-240/700	415	FUNGO	419	HAVANA MIRROR	347
DROP	645, 646	<b>G</b>		HEMERA	577
DUO	421, 422	GALA/..	44	HERO50/..	49
<b>E</b>		GEARER14PU06/..	378	HERO.ES50/..	49
ECHO	418	GEARER15PU04/..	377	HI.60./..	137
ECHO SQ	418	GENIO	343	HI.63./..	137
ELBA	586	GL413G/..	145	HI.66./..	138
ETNA 496, 497, 505, 506, 528, 529, 543, 545		GL423S/..	150	HI.67./..	138
ETNA cover on the floor 530, 531, 547, 548		GL553S/..	148	HI.71./..	138
ETNA = even with the floor 530, 544, 546		GL1129W/..	151	HORIZON	595
ETNA = EVEN WITH THE FLOOR 496, 497, 529		GL1135S/..	151	<b>I</b>	
ETNA orientation 527		GL2581S/..	147	ICARO	593
EXIT 377		GL2592SS/..	147	INCA	258, 259
EXTER 611, 646, 647		GL2718CG/..	157	INCA X	259
<b>F</b>		GL5434WA/..	150	INCA X plasterkit	258, 259
FABO/.. 39		GL5434WN/..	151	INSERTBOX1C/..	80
FARO 596		GL5648W/..	148	INSERTBOX2C/..	81
FELIX 368, 369, 370		GL5757W/..	148	INSERTBOX3C/..	82
FITTING 20, 21, 508, 509		GL5796B/..	141, 142	IRIS 598, 599, 657, 658, 659, 660, 661, 662, 663, 664, 665, 667, 668, 669, 670, 671, 672	
FLASH 293		GL5796O/..	141, 142	IRIS - CUBA SPIKE 634, 641, 642, 643, 657, 658, 659, 660, 661, 662, 663	
FLASH M10 - M10 294		GL5796S/..	141, 142	IRIS Type A	657, 660, 665
FLASH M13 294		GL5836W/..	150	IRIS Type B	658, 660, 666
FLATFACE 343		GL5911R/..	146	IRIS Type C	598, 599, 662, 666
FLAT SPRINGS 4		GL5911S/..	146	IRIS Type CR	663, 667
FLEX 152		GL5952A/..	146	IRIS Type D	659, 661, 666
FOCUS35/.. 5, 19		GL5952G/..	147	IRIS Type E	658, 661, 666
FOCUS50/.. 6, 19		GL5952R/..	146	IRIS Type F	659, 662, 667
FOLIO 12V - M10 132		GL5952S/..	151	<b>J</b>	
FORUM Fixed Lamp 344		GL5994CA/..	152	JACK	107
FORUM Portable Lamp 344		GL5995SMS/..	149	JAZZ 12V - M10	126
FOX.DIR/.. 46		GL8284M/..	149	JUBA	169
FOX.DIR.ES50/.. 45		GL8284S/..	149	JUBA + JAZZ - M10	166
FOX.FIX/.. 45		GL8284W/..	148	JUBA - M10	167, 168
FOX.FIX.ES50/.. 45		GL8285BC/..	149	JUBA supplement SWIVEL	167
FOYER 420		GL8285M/..	149	JUPITER 12V - M10	131
FRAME1A/.. 6, 77		GL8285S/..	141, 142	<b>K</b>	
FRAME1B/.. 6, 77		GLASS	143, 144, 145, 147, 148, 150	KADMOS	576
FRAME1BBOX/.. 77		GLASS G4	144, 145, 146, 147, 148, 149, 150, 151, 152	KNEEJOINT	108
FRAME1BMATRIX/.. 77		GLASS G4-G9	278, 308, 309, 611, 612	KNEEJOINT - M6 -M8 -M10	107
FRAME1C/.. 80		GLOBO 12V - M10	302	KOBUS	348
FRAME1F../S1 218		GOCCI	344	KOX CONVERTIBLE SYSTEM	58
FRAME1F../S2 218		GOTA	339	KOZA	50, 51, 52
FRAME2A/.. 6, 78		GOYA	344, 345	KRIOS	575
FRAME2B/.. 6, 78		GRAN CANARIA	155	KUBO50/..	42
FRAME2BBOX/.. 78		GUILIA	155	KUBO.ES50/..	43
FRAME2BMATRIX/.. 78		GUILIA A - B3	155	KUBOGLASS50/..	42
FRAME2C/.. 80		GUILIA A - M10	155	<b>L</b>	
FRAME2F../S1 220		GUILIA A spare glass	155	L/..	620
FRAME2F../S2 220		GUILIA B - B3	156	L1/..	559
FRAME2X80/.. 47		GUILIA B - M10	156	L2/..	559
FRAME3A/.. 6, 79		GUILIA B spare glass	156	L.60./..	139
FRAME3B/.. 6, 79		GUILIA C - B3	156	L.63./..	139
FRAME3BBOX/.. 79		GUILIA C - M10	157	LARA	348
FRAME3BMATRIX/.. 79		GUILIA C spare glass	571, 572	LAVA 489, 490, 493, 494, 495, 498, 499, 500, 501, 502, 503, 504, 517, 518, 519, 532, 533, 534	
FRAME3C/.. 81		<b>H</b>	346	LAVA cover on the floor 495, 496, 504, 522, 523, 524, 525, 526, 538, 539, 540, 541, 542	
FRAME3F../S1 221		HALIA	347		
FRAME3F../S2 221		HAVANA I			
FRAME80/.. 6, 46		HAVANA II			
FRAMEX/.. 74					

LAVA - ETNA	549 - 561	MIKA GRANDE plasterkit	324	ø70 - M10	29
LAVA = even with the floor	490 - 537	MIKA plasterkit	324	ø70 SYSTEM	31, 32
LAVA GRANDE	561, 562, 563, 566, 567	MINOS	597	ø70 SYSTEM - M10	31
LAVA GRANDE cover on the floor	562, 563, 564, 565, 566	MIN TRANSFO 60VA	170	ø72-75	19
LAVA orientation	527	MIN TRANSFO 105VA	171	ø80 32, 33, 34, 35, 38, 39, 40, 42, 43, 44, 47, 48, 49, 56, 69, 510, 511	
LEDA	576	MIRO	324, 325, 326, 401	ø80 - B3	35
LED PRISMA	378	MIRO plasterkit	326, 401	ø80 INOX 316	40, 512, 513
LETTER	620	MONET	354, 355, 356	ø80 - M10	35, 44, 49
LIMA	320	MONET CARR...	198, 199	ø80 PUNCHED	36, 37, 511, 512
LIMA FLAT	320	MONET ROND	212	ø80 SYSTEM	46, 47, 48
LIMA plasterkit	319, 320	MONET STRIP	199, 355	ø80 SYSTEM - M10	48
LINEA	463	MONTE CRISTO	303	ø85-87 SCS SYSTEM	77
LIPARA	577	MOON	329, 399	ø86	44
LOBBY	275, 276	MOON box VT	330, 399	ø90 SCS SYSTEM	77
LOFT	348	MOON box ZT	330, 399	ø100	41
LOLA	349	MOON + GLASS	329, 399	ø110 INOX 316	95, 513
LOTUS box	321, 322	<b>N</b>		ø123	94, 95
LOTUS IN	320, 321	NANA	577	OLIVIA	279, 280, 281, 282, 283, 284, 287
LOTUS UP	349	NEMEA	571	OLIVIA MINI	287, 288, 289, 290, 291
LTLED1CC.350mA/..	413	NEMO	353, 354, 672, 673	OLIVIA MINI DOWN	292
LTLED4CC.350mA/..	413	NEPTUNUS PENDEL	482	OLIVIA MINI UP	291, 292
LTLED6CC.350mA/..	414	NEPTUNUS PLAFOND	481	OLIVIA PENDEL B1	285
LTLED6CC.700MA/..	414	NEPTUNUS WALL	481	OLIVIA PENDEL B3	286
LUCIFER	350	NIKE	578, 579	OLIVIA PENDEL E27	285
LUNA	153	NOA alu - B1	159, 160, 162	OLIVIA PENDEL ES111	286
LUNA - B3	153	NOA alu - B2	159, 160	OLIVIA PLAASTERKIT	281
LUNA - M10	153	NOA alu - B3	159, 160	OLIVIA plasterkit	279
LUNA spare glass	153, 154	NOA alu - M10	160, 161	OLIVIA SJABLOON	281
<b>M</b>		NOA glass + alu	357	OLYMPIA	673
MAMBO	200, 350, 351, 352	NOA glass + alu - B1	158	ONO/..	29
MAMBO LED	353, 426	NOA glass + alu - B2	158, 162	OPERA	268, 269, 270, 271, 272, 274, 275, 303
MATRIX1C/..	80	NOA glass + alu - B3	158, 162	OPERA 4 IN LINE	273
MATRIX1F/..	218, 219	NOA glass + alu - M10	162	OPERA 6 IN LINE	273, 274
MATRIX2C/..	81	NOA - M10	159	OPERA HORIZ.	271
MATRIX2F/..	220, 221	NOA PC	358	OPERA VERT.	271
MATRIX3C/..	81	NOA PC - B1	157	ORKA 9	433
MATRIX3F/..	221, 222	NOA PC - B2	157, 161	ORKA (43M)	431
MATRIXBOX1F/..	218, 219	NOA PC - B3	157, 161	ORKA M10	141, 432
MATRIXBOX2F/..	220	NOA PC - M10	158, 161	ORKA PENDEL B1	433
MATRIXBOX3F/..	221, 222	NUMBER	616, 617, 618, 619, 620, 621, 622	ORKA PENDEL B3	433
MAURO	573	<b>O</b>		ORKA TABLE	300, 432
MAX WALL	345, 346	ø29	15, 16, 366, 367	ORKA WALL	430, 431, 432
MAX - B3	154	ø38	13, 14	OSCAR	393, 394, 395
MAX - M10	154	ø38-39	12	OSCAR X	395, 396
MAX spare glass	154	ø39-40	12, 13	OT9D.350MA/..	414
METIS	572	ø48	12, 15, 366	OT18D.700MA/..	414
METRO	466 - 480	ø48-49	11, 13	OT35.700MA/..	415
MEZZO	322	ø49	14, 19	OTTO FLY	625
MEZZO GRANDE	323	ø60	19	OTTO OUTDOOR	624, 625, 626, 627
MEZZO GRANDE plasterkit	323	ø63	14	OUTSIDER	359, 617
MEZZO plasterkit	322	ø64	19	OVALE BOX - M10	201, 202
MIA	403, 404, 405	ø65	22, 23, 24, 25, 26, 510	<b>P</b>	
MIA X- voor niko afdekkader	406, 407	ø65-70 INOX 316	20, 21, 508, 509	PALLADIO	482, 483
MICRO	353	ø65 - B3	25	PALMA	588
MIKA	323	ø65 - M10	25	PAVO	358
MIKADO	465	ø65 SYSTEM	27, 28	PH350MADRIVER/..	415
MIKADO WALL	465	ø65 SYSTEM - B3	28	PICO20/..	22, 510
MIKA GRANDE	324	ø65 SYSTEM - M10	28	PICO35/..	23
		ø70	28, 29, 30		

PICO35DOWN/..	23	S1/..	4	special 100 CONVERTIBLE SYSTEM	55
PICO50/..	32, 510	S.1F/..	218, 219	special ø75-76 CONVERTIBLE SYSTEM	55
PICO50.ESS0/..LN	37, 511	S2/..	4	SPIKE grondpin 570, 572, 573, 574, 575, 576, 578	
PICO50/..LN	36, 511	S.2F/..	220, 221	SPIKKIO	627
PICO AR70/..	41	S.3F/..	221, 222	SPINNER	248, 249, 250, 251
PICODOWN50/..	33	S5/..	56	SPINNER CDMT	249
PICODOWNRING	33	S6/..	5, 6	SPINNER ETALAGE	251
PICODOWNRING/..	33	S7/..	6	SPINNER X	243, 244, 245, 246, 247, 248
PICTO	427, 428, 429, 615	S8/..	6	SPINNER X AR70	239, 240, 241, 242, 243
PICTO SENSOR	428, 429, 615	S9/..	7	SPINNER X AR70 plasterkit	239, 240, 241
PICUS	571	S10.198/..	7	SPINNER X DOWNRING	233
PIEDRO	673, 674	S11/..	7	SPINNER X FORUM	233, 234, 235, 236, 237, 238, 239
PIGLAS/..	143	S12/..	6, 7	SPINNER X FORUM plasterkit	233, 234, 235, 236
PIVA - B3	141, 143	S13/..	6, 8	SPINNER X plasterkit	243, 244, 245
PIVA - M10	141, 142, 143	S14/..	7, 8	SQUARE 12V - M10	172, 173, 174
PLASTERKIT	5, 6, 7	S15/..	7, 8	SQUARE 230V - M10	174, 175, 176
PLAZA	213	S302/..	673, 674	SQUARE SALSALSA	177
PLUTO	423	S1136.5.135/..	556	ST33/..	5, 10
POLO	573, 574	S1136.9.135/..	556	ST43/..	5, 10
PONTOS	570, 572, 573	S1138.5.135/..	557	ST50X50/..	5, 10
PORTO	579, 580, 581	S1138.9.135/..	557	standard ø80 CONVERTIBLE SYSTEM	55
PRADO	401	S1139.5/..	532, 533, 534, 535, 536, 537, 543, 544, 545,	STAR	213
PRADO box	401, 402	546, 551		STARLIGHT	10
PRADO X	402	S1139.9/..	532, 533, 534, 535, 536, 537, 543, 544, 545,	STARLIGHT ø30	10
PRADO X box	402	546, 551		STEP 12V - M10	129
<b>Q</b>		SATURNO 12V - M10	134	STEP 230V - M10	137
QUAD/..	44	SATURNO 230V - M10	138	STEP + LED - M10	139
QUADRO	251, 252, 253	SCALA	587	STONE	591, 592, 632, 633
QUORUM	260, 261	SCOOP/..	94	STONE box	591, 592, 632, 633
<b>R</b>		SCOOPC/..	94	STONE LED	425, 632
R1028/..	156	SCOOPNODOT/..	95	STRIPE	200, 201, 356, 357
R1029/..	155	SCOTT	374, 375	SUISSE	597, 598
RAL COLOUR	4	SCOTT CARREE	375, 376	SUN	330, 331, 400
RAYA	359	SCREEN	316, 317	SUN + Glass	400
RAYA MINI	359	SCREEN box	316, 317	SUN + GLASS	330
RECTO SCREEN	319	SCREEN plasterkit	316, 317	SUNGLASS	331, 332
RECTO SCREEN box	319	SCS SYSTEM	74 - 94	SUPPLEMENT DIMABLE/..	441
RECTO SCREEN plasterkit	319	SCS SYSTEM - B3	85	SUPPLEMENT LARGER COVER PLATE	556, 557
RETRO	257, 258	SCS SYSTEM - M10	85	SUPPLEMENT SQ GLASS	532, 533, 534, 535, 536, 537,
RINGO	213, 214, 215	SENSA/..	39	543, 544, 545, 546, 551	
RING RING	618, 619	SEXTRACIRCUIT/..	439, 440, 469, 470	SUPPLEMENT TRANSFO 60VA	170
RIO35/..	5, 6, 13	SINGLE65/..	26	SUPPLEMENT TRANSFO 105VA	171
RONDO BOX - M10	202, 203, 204	SINGLE70/..	30	SUPPORT FOR FLOODLIGHT	578
RONDO CLICK I	205	SINGLEBASE/..	56	SURF	360
RONDO CLICK II	205	SINGLE MOON	327, 397	SWING	357
RONDO CLICK III	206	SINGLE MOON box VT	327, 328, 397	<b>T</b>	
RONDO CLICK IV	206	SINGLE MOON box ZT	327, 328, 397	T./..	665
ROSETTE	112, 116	SINGLE MOON + GLASS	327, 397	T1/..	664
ROSETTE M6-M8-M10-D8,3	111, 115	SIRA35CH/..	23	T1MT/..	664
ROSETTE - M10	108, 109, 110, 112, 113, 114, 116, 117,	SIRA35M/..	24	T2/..	664
118, 119, 120, 121, 122, 469		SIRA50CH/..	35	T3/..	664
ROSETTE - M10-M8-M6-D8,3	118	SIRA50M/..	35	T4/..	665
ROSETTE-M10-M8-M6-D8,3	119, 120, 121	SIRIO	215	T5/..	662, 665
ROSETTE - M12	117, 468	SLIDE	483	T5 FQ-FH/..	471
ROUNDBASE/..	55	SMALL SCREEN	318	T5 x 1/..	440
ROUNDBASE.D100/..	55	SMALL SCREEN box VT	318	T5 x 1SQ/..	440
ROUNDBASEUSA/..	55	SMALL SCREEN plasterkit	318	T5 x 2/..	440
RYTA	674, 675, 676	SNOWBOX	253, 254	T5 X2SQ/..	441
<b>S</b>		SPAZIO	302	T26/..	471
		SPAZIO - B2	163		

T100.A/..	660	T489/./..	588	T7037.85/..	608, 654
T100.A/..	657	T490/..	578	T7039.65/..	609, 655
T100.B/..	660	T492/./..	589	T7039.85/..	609, 655
T100.B/..	658	T498/./..	593	TC-L EVG/..	473
T100.D/..	661	T499/./..	598	TC-L KVG/..	473
T100.D/..	659	T500/..	594	TERMINAL BLOCK CONVERTIBLE SYSTEM	56
T100.E/..	661	T500/./..	594	TEXO - M10	121, 171, 172
T100.E/..	658	T599/./..	597	TITUS 230V	195, 196
T100.F/..	662	T1001/..	570, 572, 573, 574, 575, 576, 578	TITUS Round	211, 212
T100.F/..	659	T1021/..634, 641, 642, 643, 657, 658, 659, 660, 661, 662,		TITUS SQ	196, 197
T101.C/./..	598, 662	663		TOLEDO	96- 100, 582 - 586, 620, 628 - 631
T101..CR/..	663	T1021.T5/..	598, 599	TOLEDO ø84	101, 103
T109/..	634	T1021.T30/..	598, 599	TOLEDO SPIKE	582, 583, 584, 628, 629, 630
T205/./..	590	T1022/..	663	TOLEDO WALL	362
T206/..	590	T1023/..	657, 660, 665	TORPEDO	263, 264, 265, 266, 267, 268
T207/..	590	T1024/..	658, 660, 666	TORSION SPRINGS	4
T299.250/..	579	T1025/..	659, 661, 666	TOSSA	589
T299.450/..	579	T1026/..	658, 661, 666	TOTEM	302
T299.750/..	580	T1027/..	598, 599, 662, 666	TOTEM MINI	302
T300.250/..	580	T1028/..	663, 667	TR20/..	8
T300.450/..	580	T1029/..	659, 662, 667	TR30/..	9
T300.750/..	580	T1030/..	604, 650	TR40/..	9
T301.75/..	673	T1030/./..5M	604, 651	TR60/..	9
T302.700/..	673	T1031/..	605, 651	TR60VAMIN/..	170
T302.1000/..	674	T1032/..	605, 651	TR60VAPLUS/..	170
T303R/..	582, 628	T1033/..	602, 648	TR80/..	9
T303S/..	582, 628	T1034/..	602, 648	TR105VAMIN/..	171
T304R/..	583, 629	T1035/..	602, 648	TR105VAPLUS/..	171
T304S/..	584, 630	T1036.45/..	603, 649	TRANSFOKAST	8, 9
T305/..	582, 583, 628, 629	T1036.65/..	603, 649	TRANSFORMER BOX	122, 123
T307/..	583, 584, 629, 630	T1036.85/..	603, 650	TRANSFORMER BOX - M10	122
T310.1345/..	595	T1037/..	602, 649	TRANSFO voltage power supply	377, 378
T311.2000/..	595	T1038/..	603, 649	TRIPLEBASE/..	58
T312.85/..	594	T1039.65/..	604, 650	TRIPLE MOON	328, 398
T313.85/..	595	T1039.85/..	604, 650	TRIPLE MOON box VT	328, 329, 398
T314/..	595	T1040.100/..	674	TRIPLE MOON box ZT	328, 329, 398
T397/..	578	T1040.400/..	674	TRIPLE MOON + GLASS	328, 398
T398/..	579	T1041.100/..	675	TUBA 12V - M10	127
T399/..	579	T1041.400/..	675	TUBA - B3	152
T400/..	578	T1042.100/..	675	TUBA - M10	152
T401/./..	570	T1042.400/..	675	TUCAN	371, 372, 373
T403.600/..	570	T1043.100/..	676	TURNER	299
T406/./..	572	T1043.400/..	676	TWIN65/..	6, 26
T410/./..	597	T1082/..	646	TWIN70/..	6, 30
T414/./..	576	T1094.LED/./..	638	TWINBASE/..	6, 57
T418.60/..	575	T1095.LED/..	637	TWIPE	276, 277
T419.80/..	575	T1206.A/..	610	TWIPE PENDANT	277
T420/./..	575	T1206.C/..	611	TWIST 12V - B3	135
T424.600/..	596	T1332/..	639, 643	TWOBASE/..	57
T425/./..	596	T7030/..	609, 655	TYPE A : LED CASSETTE 230V 3,6W IP65 , 516, 581, 103	
T427.700/..	574	T7030/./..5M	609, 655	TYPE B : LED CASSETTE 24V-DC 3,6W IP65 , 516, 581, 103	
T430/./..	576	T7031/..	610, 656	TYPE C : LED CASSETTE 230V 4W IP65	488, 516
T440/./..	575	T7032/..	610, 656	TYPE D : LED CASSETTE 24V-DC 4W IP65	488, 516
T450/./..	570	T7033.45/..	607, 653	<b>U</b>	
T453.600/..	570	T7033.65/..	607, 653	UFO	601, 602, 603, 604, 605, 610, 647, 648, 649, 650, 651, 656
T454/./..	573	T7033.85/..	607, 653	UFO GRANDE	606, 607, 608, 609, 610, 652, 653, 654, 655, 656
T460/./..	573	T7036.45/..	608, 654		
T470/./..	571	T7036.65/..	608, 654		
T483/./..	586	T7036.85/..	608, 654		
T486/./..	587	T7037.65/..	607, 653		

UNO	421	W709/..	600	W1204/./ES50	627
UTOPIE 12V - M10	133	W710/..	600	W1205/./ES50	627
<b>V</b>		W716/..	600	W1207/./MT	646
VARIO2X35/..	6,22	W717/..	600	W1208.35W/..	611
VARIO35/..	6,22	W1050A/..	667	W1208.70W/..	611
VARIO50/..	47,48	W1051A/..	667	W1209.35W/..	646
VARIO.E550/..	47,48	W1052B/..	668	W1209.70W/..	647
VENUS	576	W1052D/..	668	W1210/..	591
VIDRIO/..	40	W1052E/..	668	W1211/..	591
VIDRIO50/..	34	W1052F/..	668	W1212/..	591
VIDRIOGLASS/..	34	W1053B/..	669	W1213B/..	591
VIOLA 12V - M10	128	W1053D/..	669	W1214/..	592,632
VITO	361,656,657	W1053E/..	669	W1215/..	592,632
VLMPTDCC3.350MA/..	416	W1053F/..	669	W1216/..	592,633
VLMPTDCC15.350MA/..	415	W1054C/..	598,670	W1217B/..	592,632,633
VLMPTDCC15.700MA/..	415	W1055CR/..	670	W1218A/..	425,632
VLMPTDCCD15.350MA/..	416	W1056A/..	670	W1218B/..	425,632
VLMPTDCCR.350MA/..	416	W1057B/..	670	W1220.40X/..	593
VLMPTRDCC15.350MA/..	416	W1057D/..	671	W1221.5X/..	593
VLMPTRDCC15.700MA/..	417	W1057E/..	671	W1250/..	617
VOGUE	304,305,306	W1057F/..	671	W1250/./C	617
VOLARE	610,611	W1058C/..	671	W1251/..	617
VOLTA	166,299	W1058CX/..	599	W1252/..	617
VOLTA 12V - M10	132,294	W1059CR/..	672	W1292A/..	622
VOLTA + JUBA 1	167	W1060/..	656	W1292B/..	623
VOLTA + JUBA 2	167	W1061/..	657	W1292C/..	623
<b>W</b>		W1070/..	601,647	W1292D/..	623
W299/..	581	W1071/..	601,647	W1292E/..	623
W300/..	581	W1072/..	601,647	W1292F/..	624
W301/..	673	W1073/..	601,648	W1292G/..	624
W303/./R	584,620	W1075/..	625	W1295E/..	638
W303/./S	585,620	W1076/..	625	W1301.220/..	643
W304/./R	585,630	W1076.2/..	626	W1302/..	639
W304/./S	585,631	W1077/..	626	W1303.220/..	644
W306/./R	585,631	W1077.2/..	626	W1304/..	639
W306/./S	586,631	W1078/..	626	W1305/..	639
W500/..	594	W1078.2/..	627	W1306/..	639
W501/..	576	W1079/..	625	W1307/..	640
W503/..	577	W1080/..	645	W1308/..	640
W505/..	586	W1081/..	646	W1309/..	640
W506/..	587	W1082/..	624	W1310/..	640
W507/..	588	W1083/..	624	W1311/..	641
W508/..	589	W1084/..	625	W1312/..	641
W510/..	589	W1085/..	672	W1313/..	641
W600/..	576	W1086/..	672	W1314/..	641
W601/..	577	W1087/..	672	W1315/..	642
W602/..	577	W1088/..	673	W1316/..	642
W603/..	577	W1090/./UP	633	W1317.220/..	644
W701/..	571	W1091/./UP	633	W1318.220/..	644
W701B/..	571	W1092/..	634	W1319.220/..	644
W702/..	571	W1094/./UP	634	W1320.220/..	645
W702B/..	572	W1095/./UP	634	W1321.220/..	645
W703/..	572	W1096.LED/..	424,637	W1322.220/..	645
W704/..	572	W1097.LED/..	424,637	W1324/..	642
W707/..	573	W1098/./DOWN	635	W1330/..	642
W708.A/..	573	W1098/./UP	635	W1331/..	643
W708.B/..	574	W1099/./DOWN	635	W1332/..	643
W708.C/..	574	W1099/./UP	635	W1339/..	621
W708.D/..	574	W1200/..	636	W1340/..	621
		W1203/./ES50	627	W1341/..	621

W1342/..	621	W3092.MT/..	618	ZOOM CLICK II	184, 185
W1343/..	622	W3093.MT/..	618	ZOOM CLICK III	185
W1354/./S1	389	W3094.MT/..	619	ZOOM CLICK IV	186
W1354/./S2	389	W3097.MT/..	619	ZOOM CLICK + VERA	186, 187
W1355/./S1	388	W3098.MT/..	619	ZOOM CLICK + VOLTA	188, 189, 190, 191, 192
W1355/./S2	388	W3099.MT/..	619	ZOOM - M10	180, 181, 182
W1358/./S1	389	W3105/..	372	ZOOM TWIST	178
W1358/./S2	389	W3106/..	372	ZUMBA	295, 296
W1360/./S1	390	W3107/..	372	ZUMBA - M13	295
W1360/./S2	390	W3108/..	373		
W1361/./S1	390	W3109/..	373		
W1361/./S2	390	W3110/..	372		
W1362/./S1	391	W3111/..	373		
W1362/./S2	391	W7070/..	606, 652		
W1365/..	392	W7071/..	606, 652		
W1366/..	392	W7072/..	606, 652		
W1367/..	392	W7073/..	606, 652		
W1370/..	369	WAVE	363		
W1371/..	369	WING	306, 307, 484, 485		
W1372/..	370	WING FLOOR LAMP	308		
W1374/..	370	WING PENDANT	485, 486		
W1375/..	370	WING TABLE LAMP	308		
W1376/..	370	WING WALL	486		
W1663/..	428, 615	WO	558		
W1663.SEN/..	428, 615	WO/..	558		
W1664/..	429, 615	<b>X</b>			
W1664.SEN/..	429, 615	XENON	363		
W1830/..	611	<b>Y</b>			
W1831/..	612	YOKO/..	29		
W1832/..	612	YOKO.ESS0/..	29		
W2400/./1LED	419	<b>Z</b>			
W2400/./2LED	419	ZEN 50	362		
W2400/./3LED	419	ZEN 100	362		
W2400/./4LED	419	ZENIT	574		
W3061/./B	97	ZENO35/..	25		
W3061/./W	97	ZENO35B3/..	25		
W3062/./B	99	ZENO50/..	35		
W3062/./W	99	ZENO50B3/..	35		
W3064/..	96	ZEN pl26	363		
W3065A/..	98	ZIA35/..	5, 11		
W3065B/..	98	ZIA35C/..	5, 13		
W3068/..	102	ZIA35CG/..	5, 14		
W3069/..	100	ZIA35M/..	5, 13		
W3079/..	100	ZIA35P/..	5, 12		
W3080A/./S	616	ZIA35V/..	5, 12		
W3080B/./DOWN	616	ZIA35VT/..	5, 12		
W3080C/./S	616	ZIA50/..	14		
W3082.10/..	422	ZIA50GR/..	14		
W3082.40/..	422	ZIA50V/..	5, 14		
W3083.10/..	374	ZIA BASE ø30 -M10-M6-M8-D8,3	16		
W3083.25/..	374	ZIA BASE ø39-40 -M10-M6-M8-D8,3	16		
W3083.40/..	374	ZIALED/..	15, 366		
W3083A/..	374	ZIALED.230V/..	15, 366		
W3083B/..	375	ZIAMINI.C.LED/..	16, 367		
W3083C/..	375	ZIAMINILED/..	15, 366		
W3084.10/..	375	ZOOM	45, 180		
W3084.25/..	375	ZOOM BOX - M10	181		
W3084.40/..	376	ZOOM CLICK	184		
W3090.MT/..	618	ZOOM CLICK 4 in line	185, 186		
W3091.MT/..	618				